

*Edinburgh 2*  
*Art. Nr. 407640*  
*1/14*

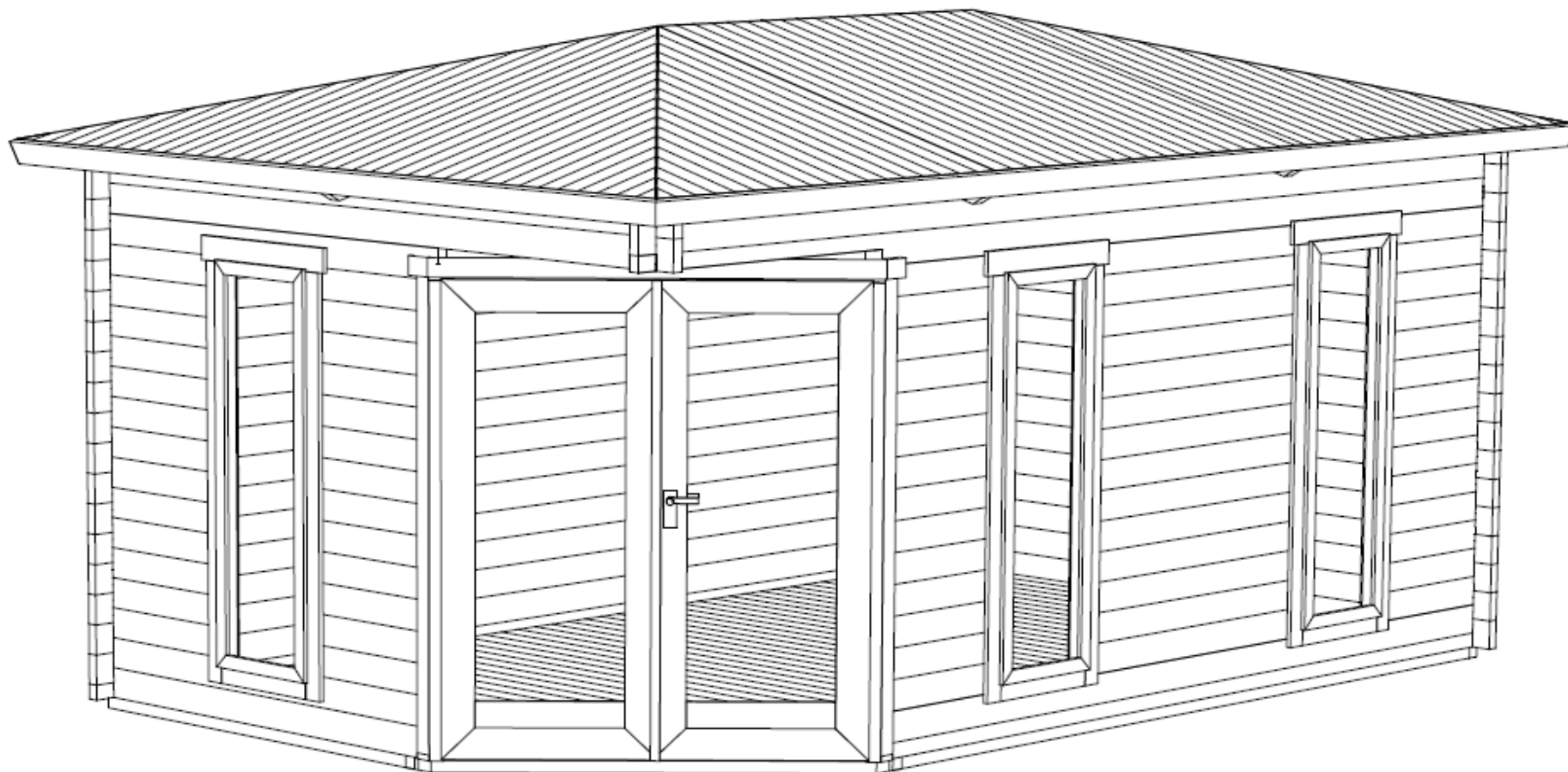

Art.Nr. 407640  
 GROUNDPLAN - GRUNDPLAN - PLAN DE MASSE

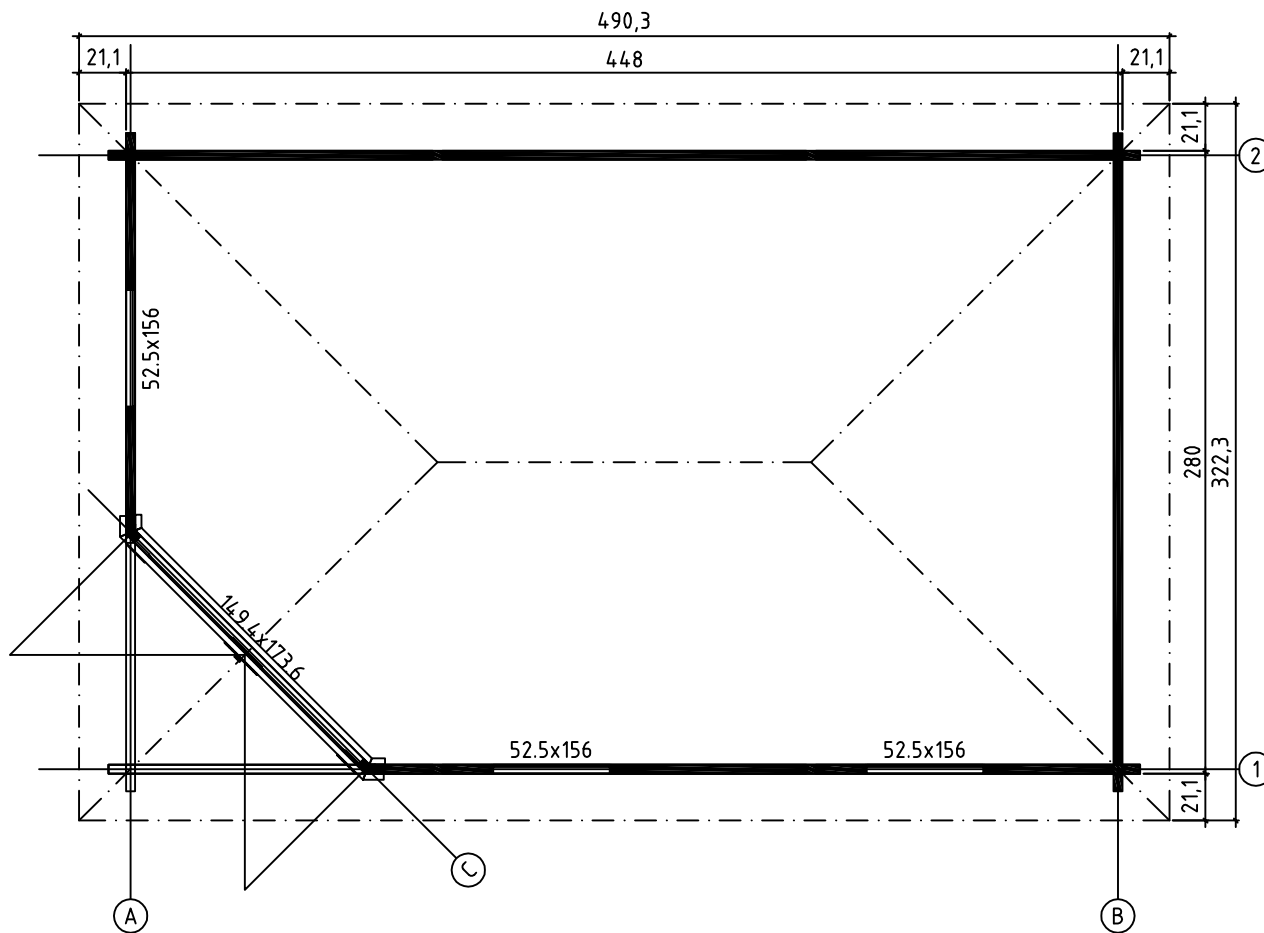

FOUNDATION - FUNDAMENT - FONDATION

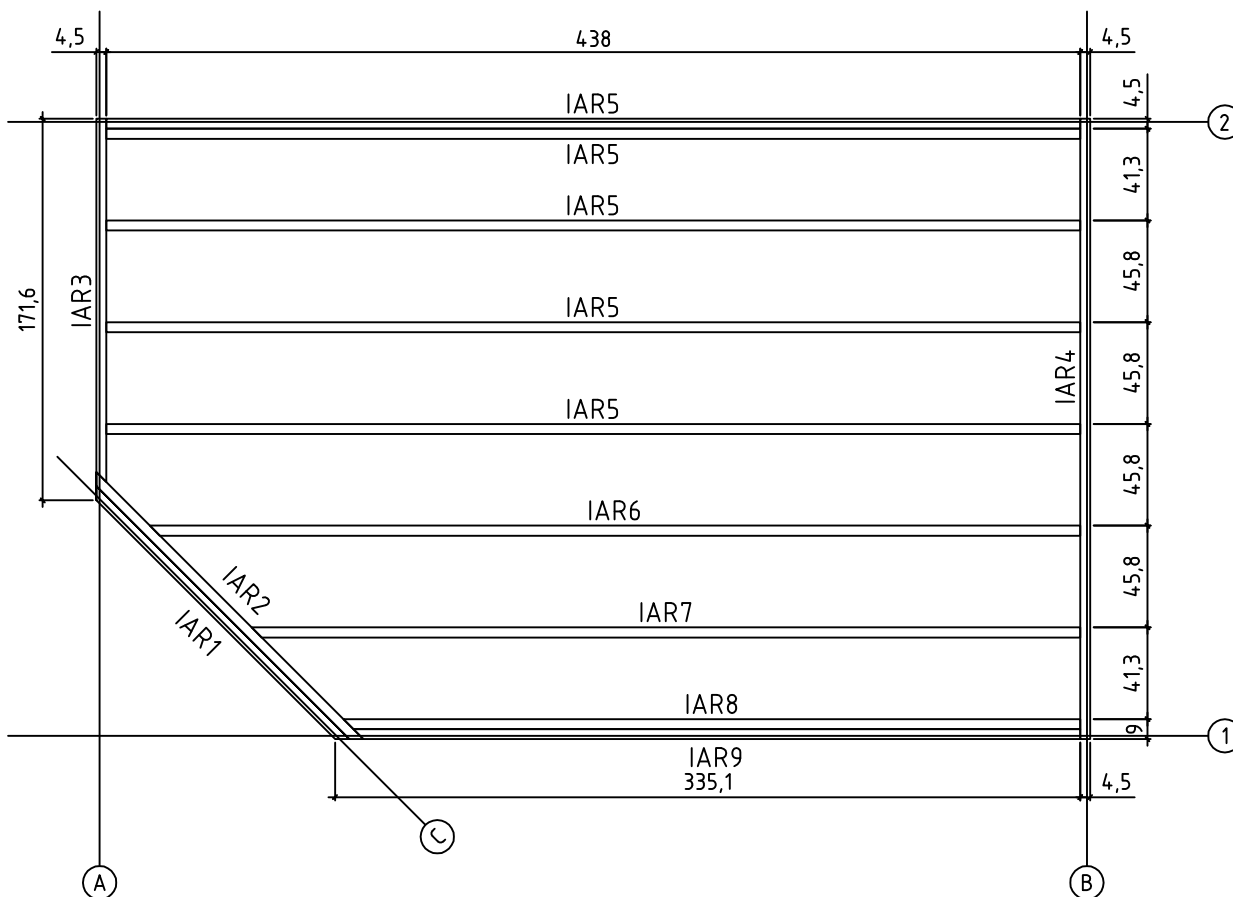

Art.Nr. 407640

# FLOOR BOARDS - FUSSBODENBRETTER - PLAN POSE PLANCHER

Mounting direction - Aufbausritte - Instruction de montage

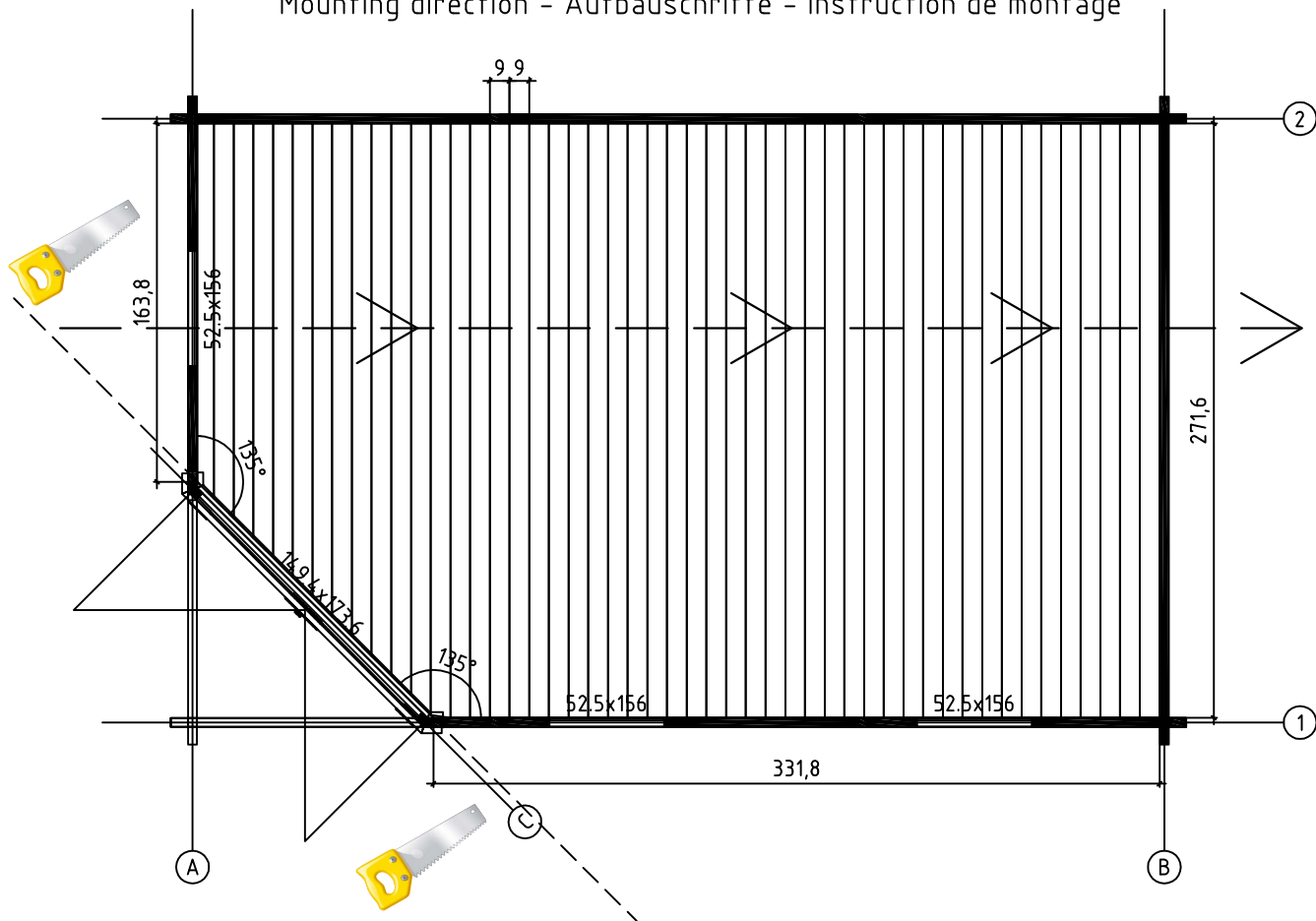

## OVERHEAD BEAMS - DECKENBALKEN - SOLIVES

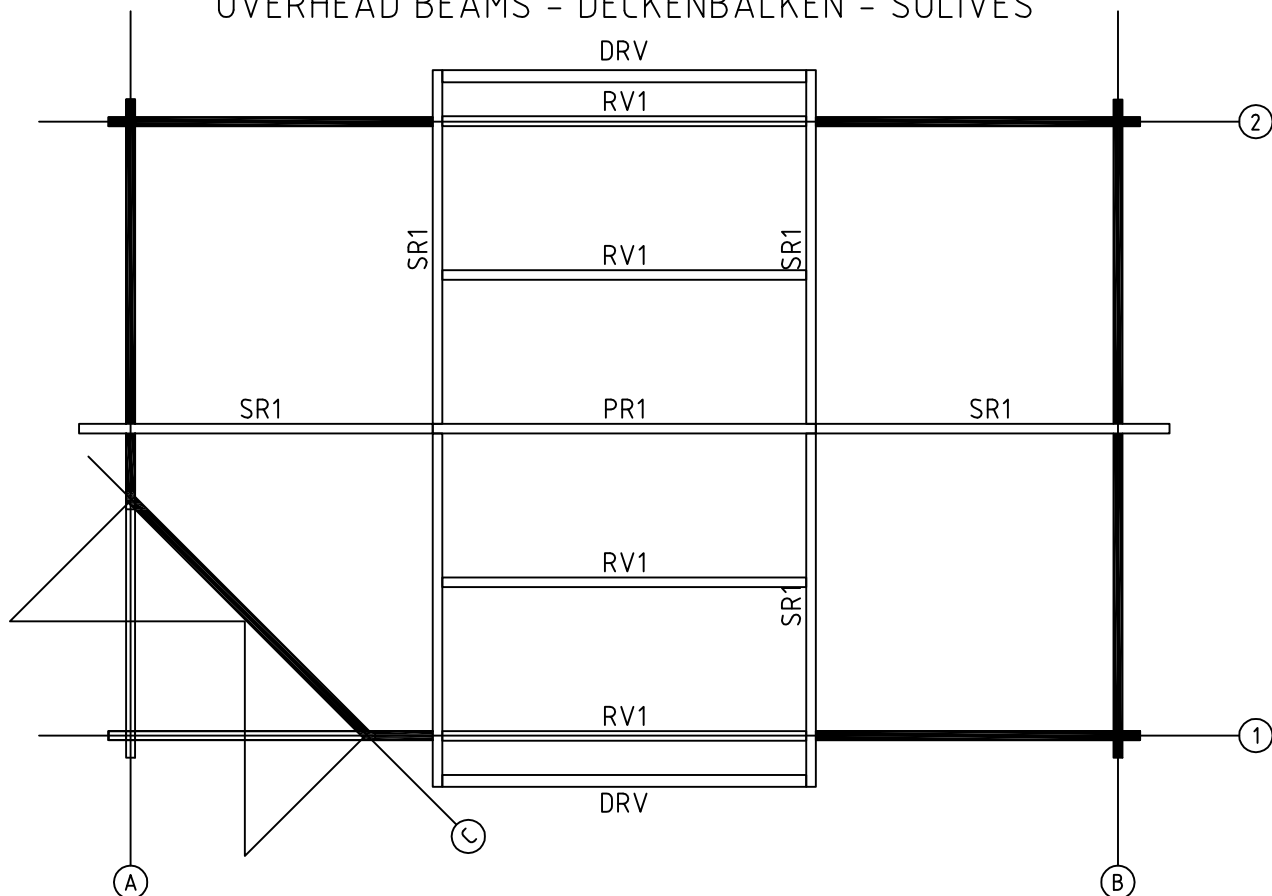

Art.Nr. 407640

Diagonal must be equal A=B - Prüfung diagonale Austrichtung A=B -  
- Controle des diagonales A=B

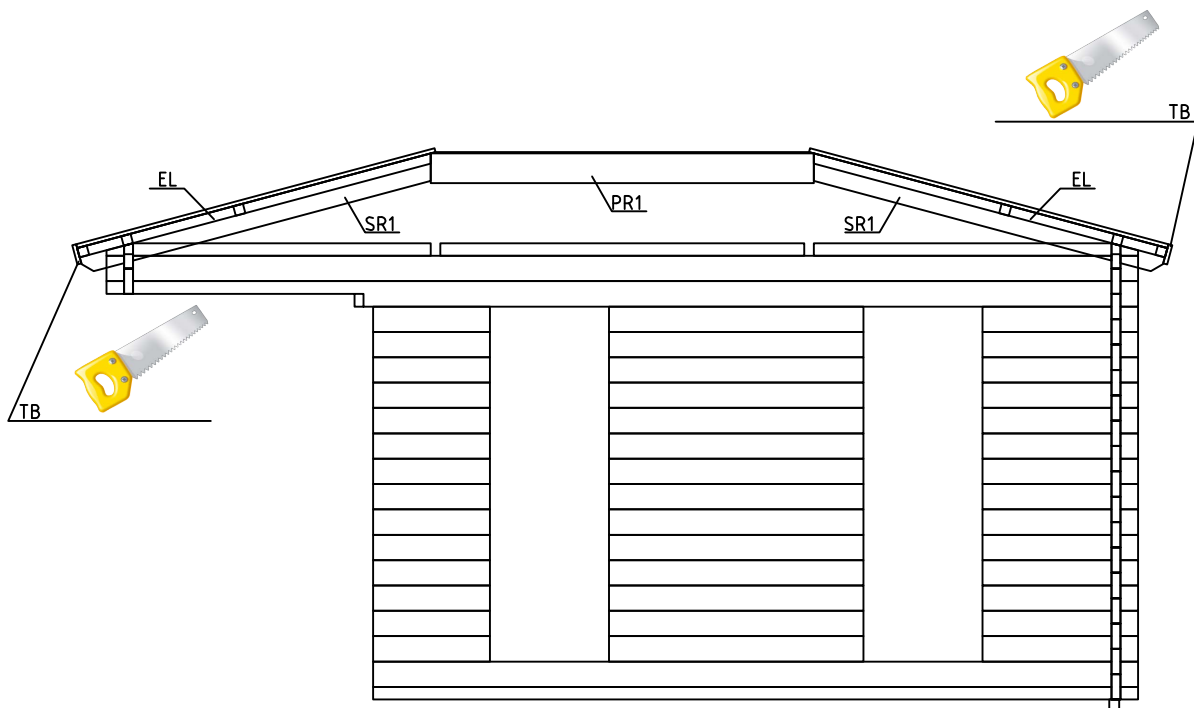
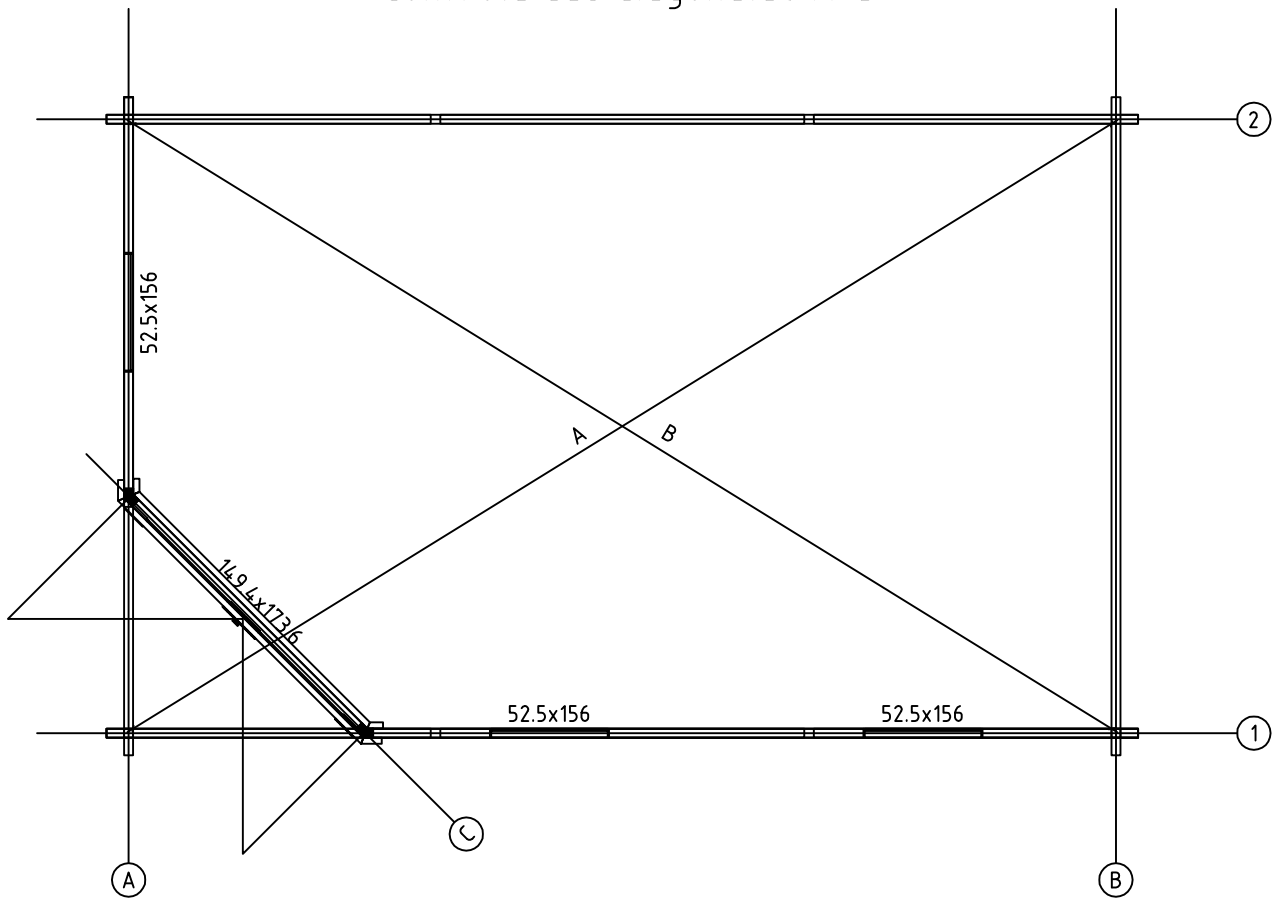

Art.Nr. 407640

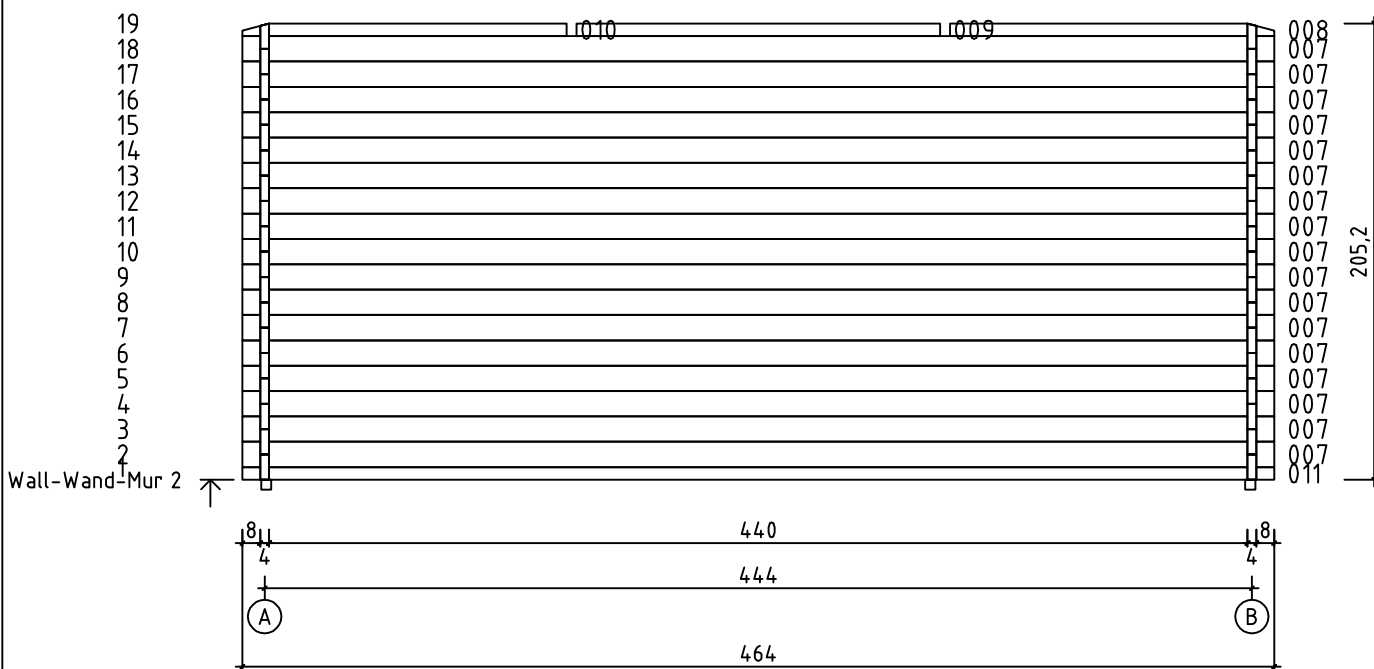
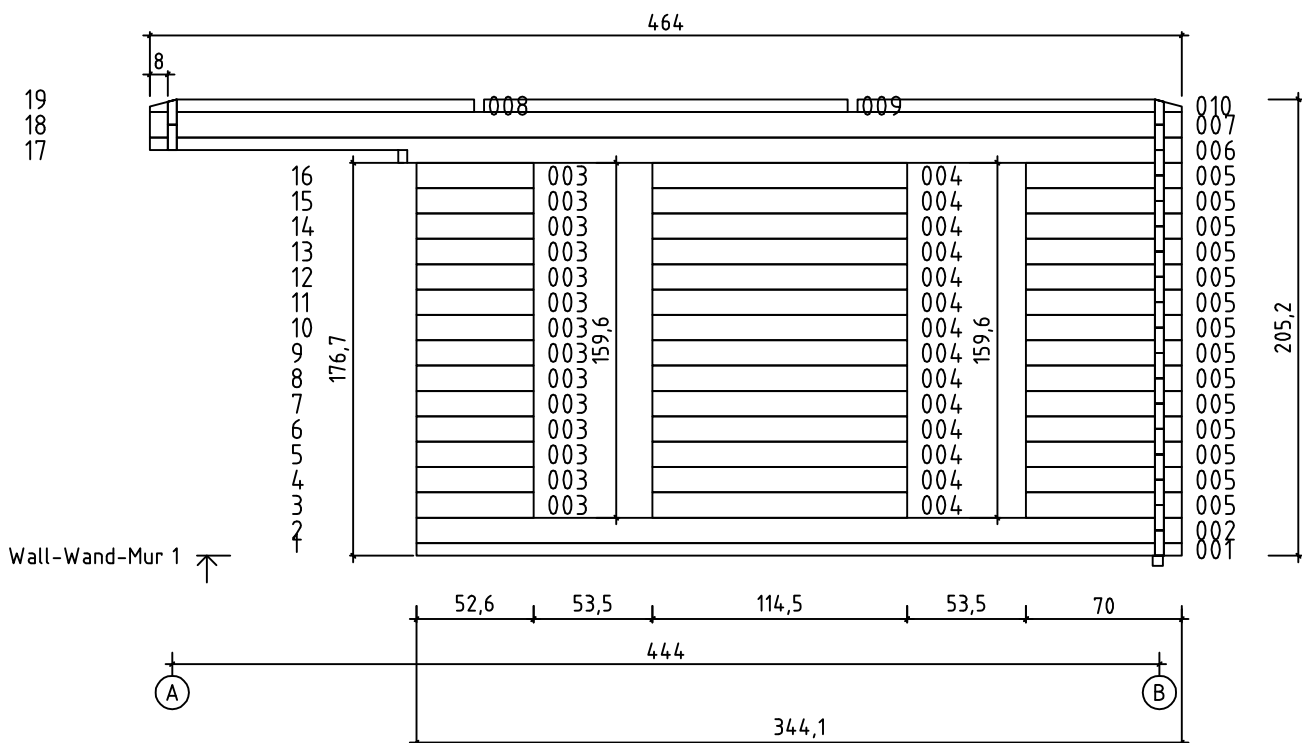

Art.Nr. 407640

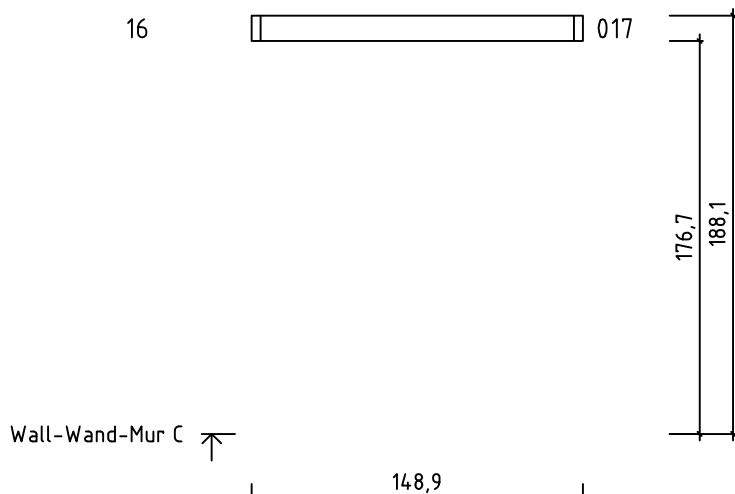
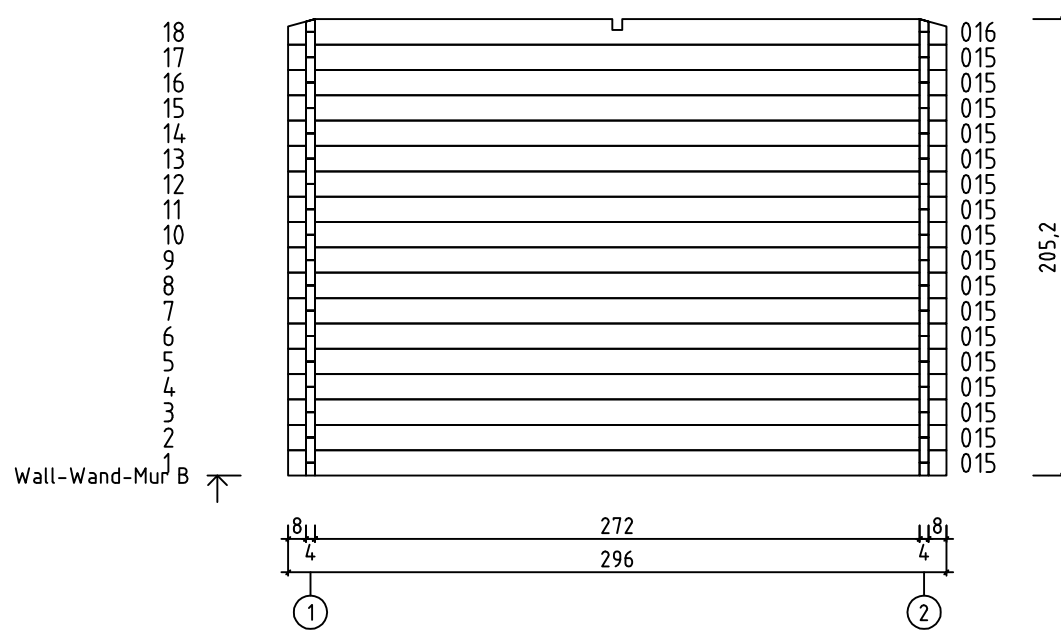
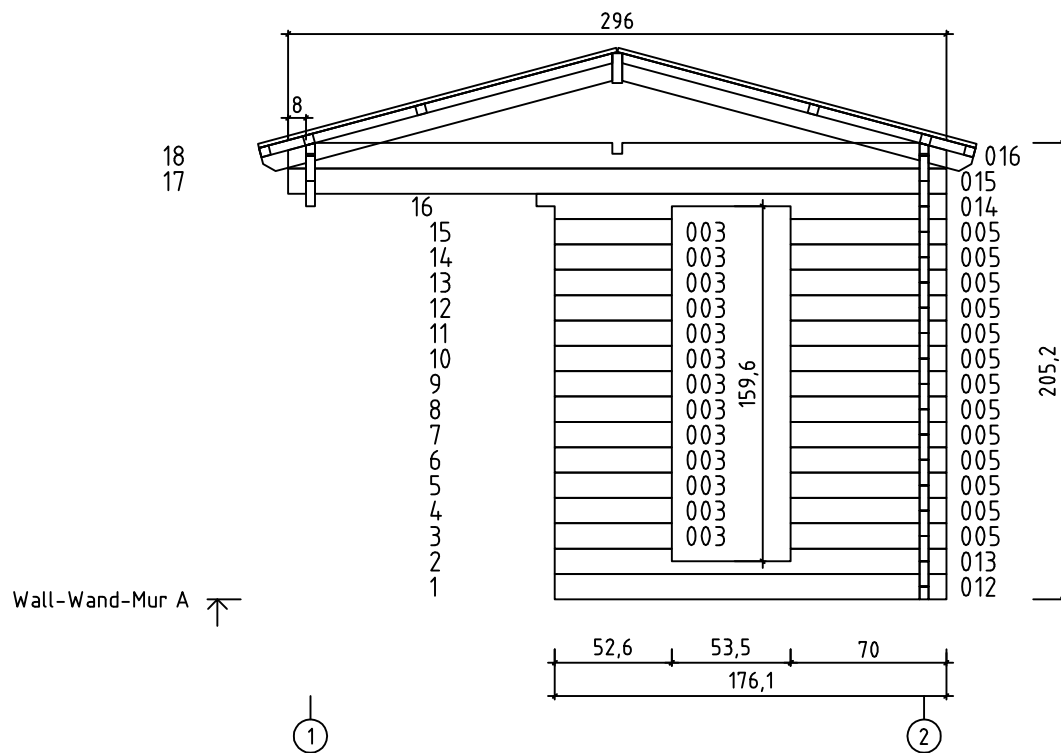

Art. Nr. 407640

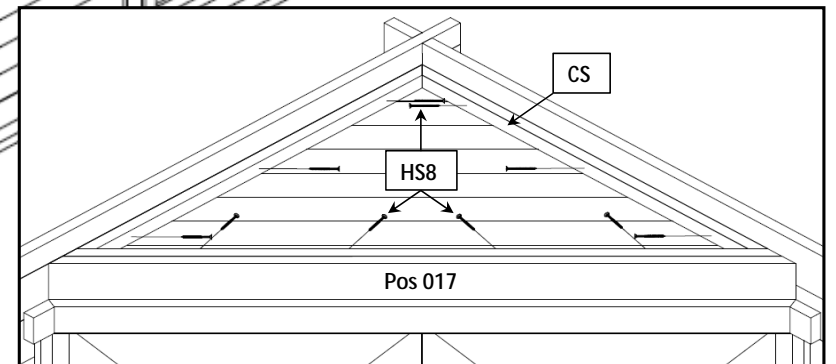
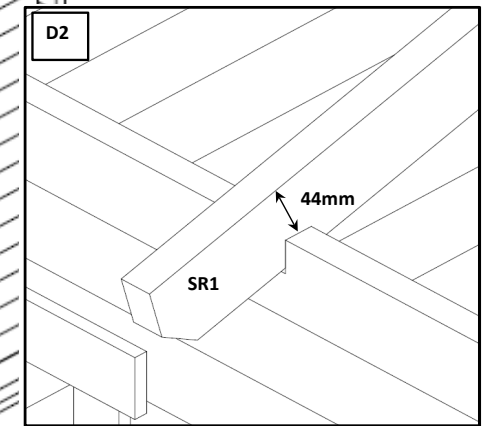
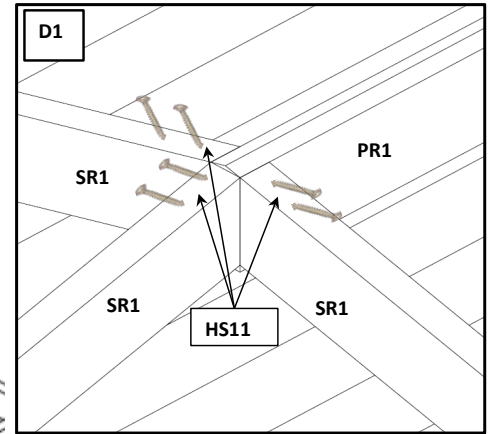
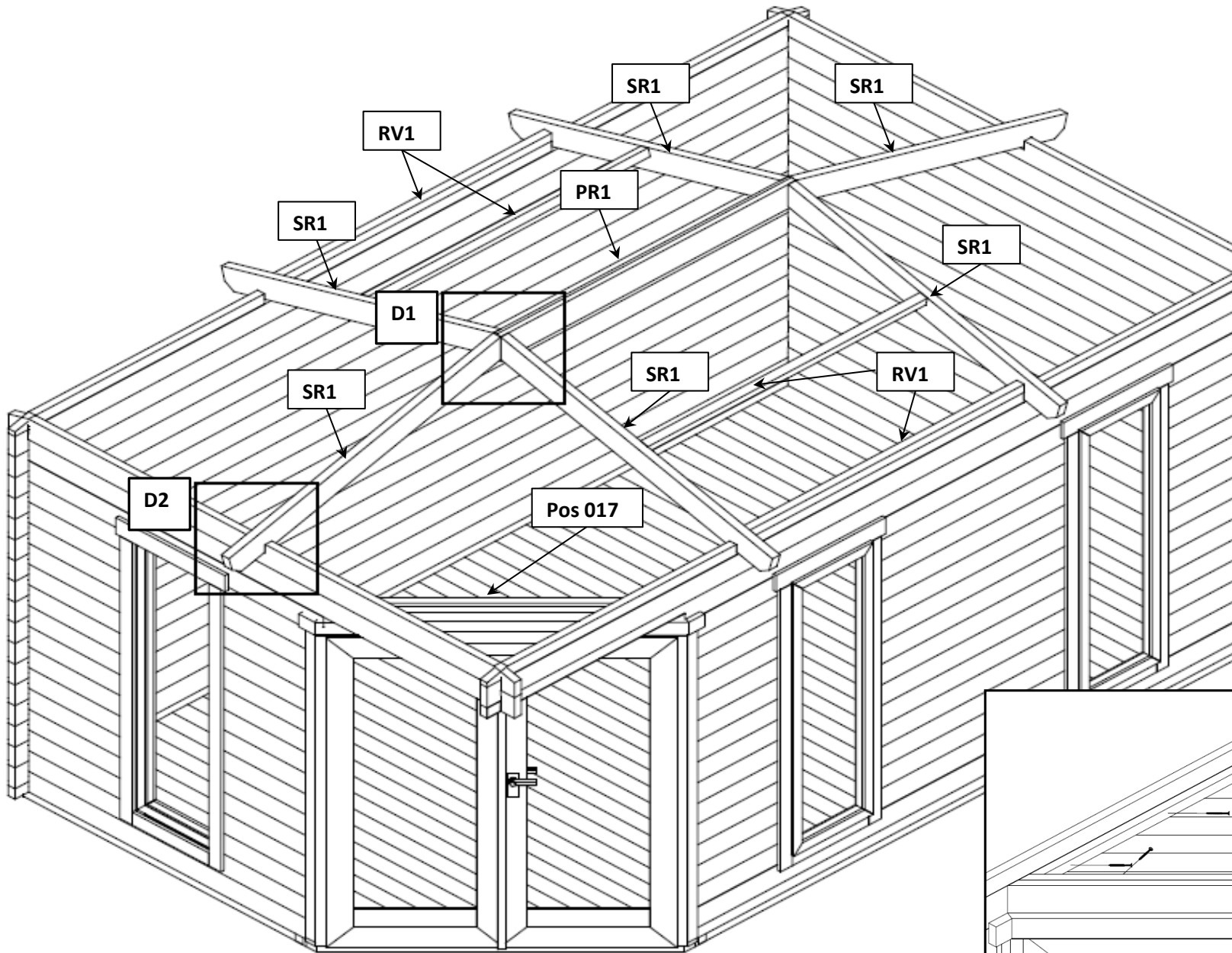

Art. Nr. 407640

TOP VIEW - ANSICHT VON OBEH - VUE DE DESSUS

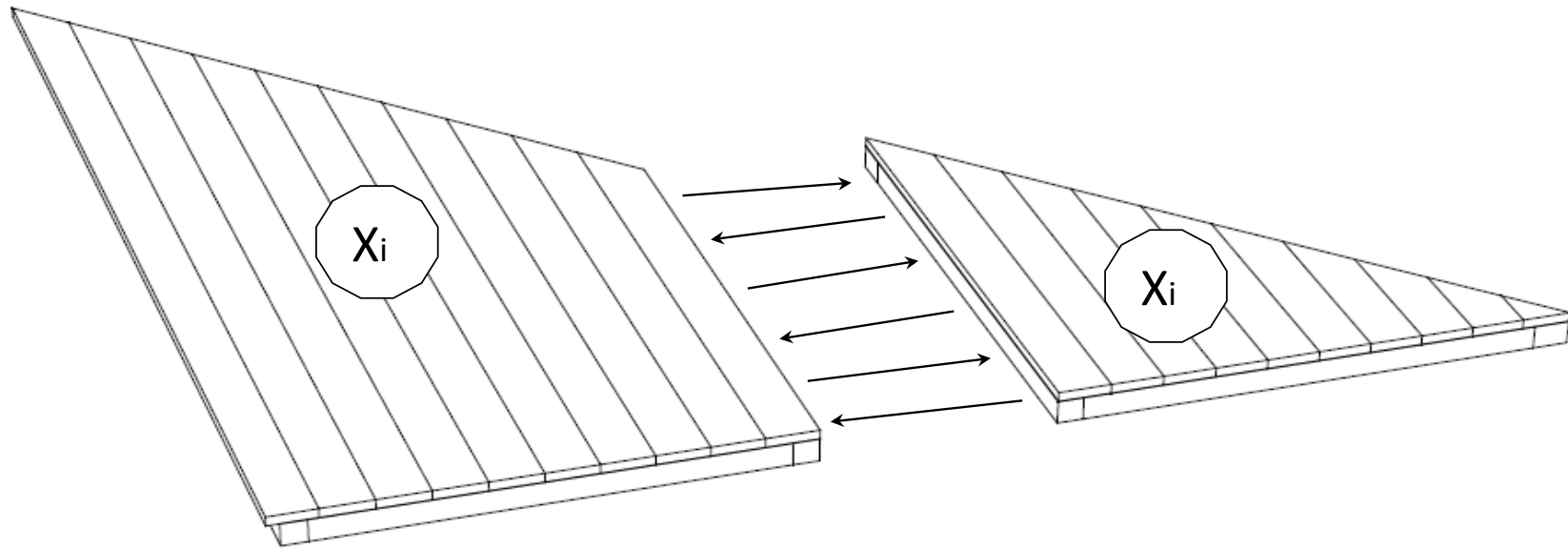

FROM BELOW - VUE DE DESSOUS - ANSICHT VON UNTEN

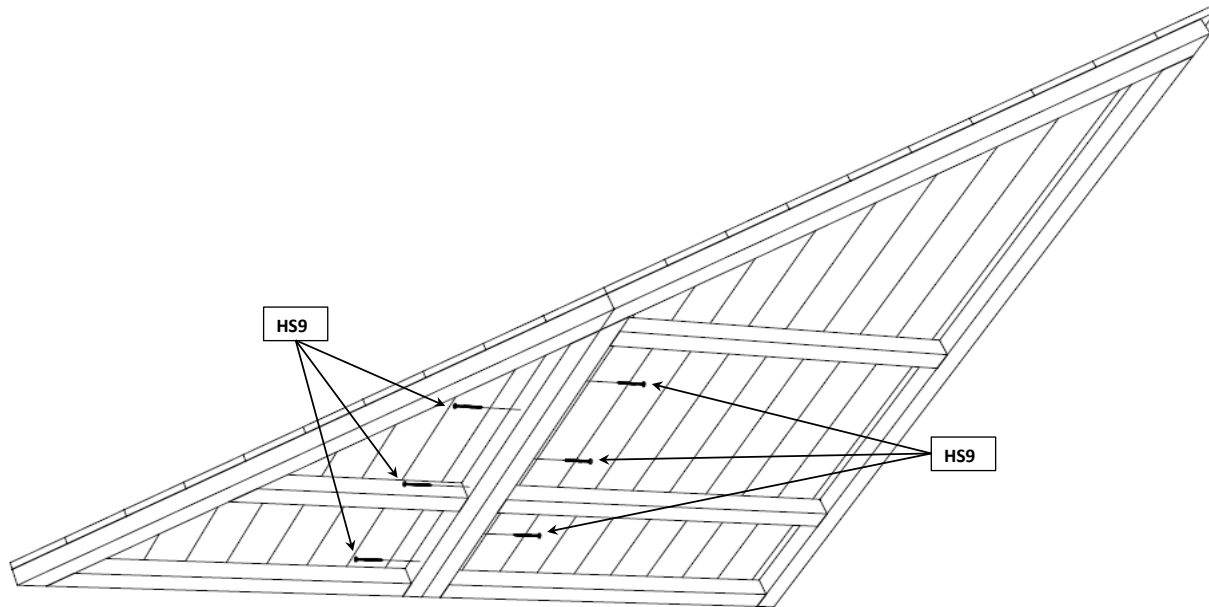



FROM BELOW - VUE DE DESSOUS - ANSICHT VON UNTEN

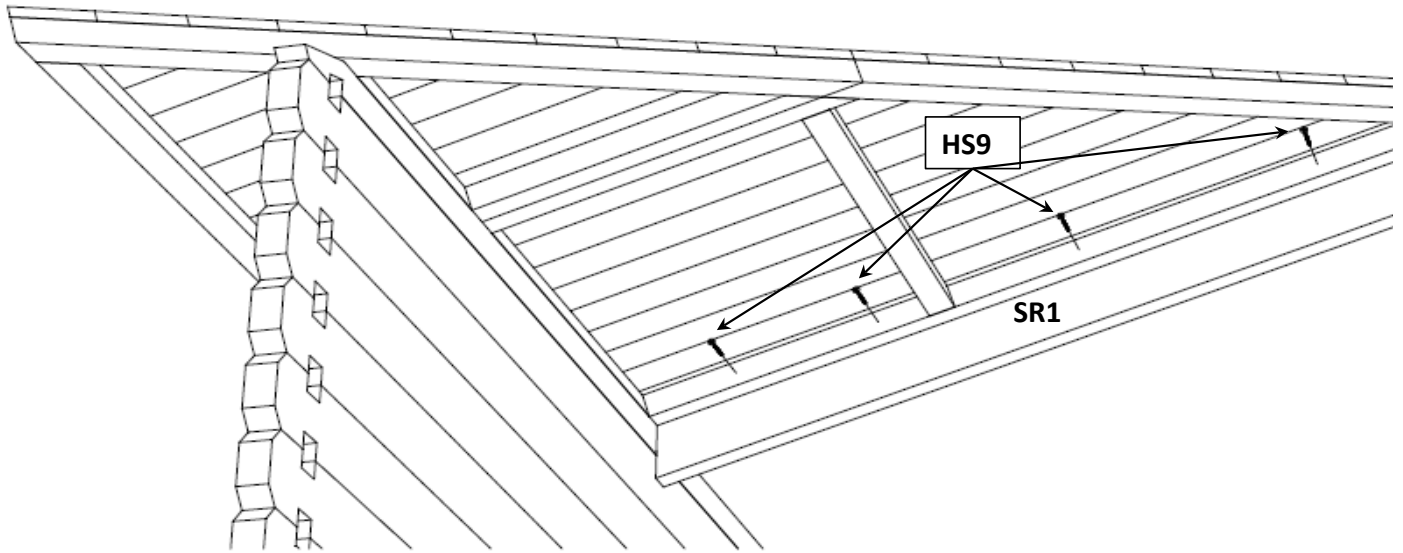



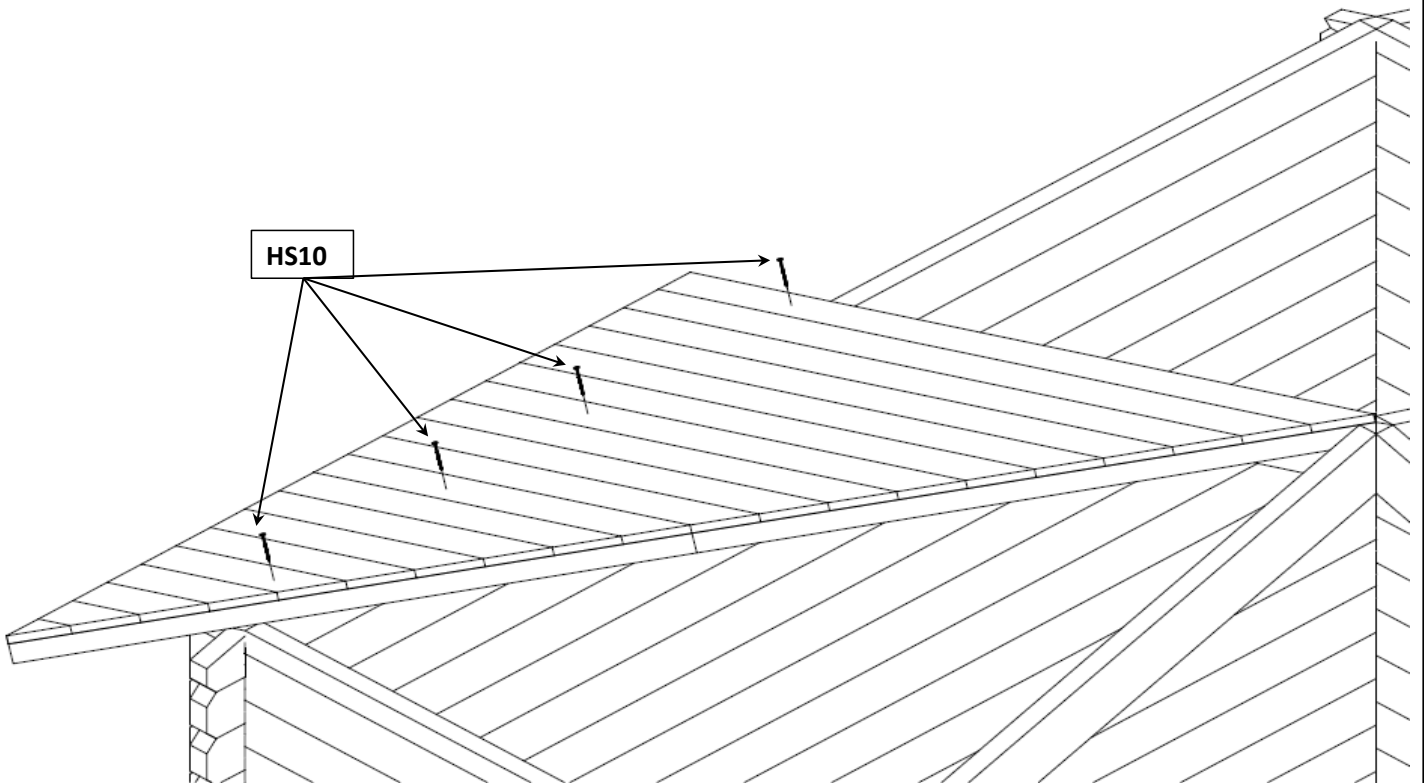

TOP VIEW - ANSICHT VON OBEH - VUE DE DESSUS

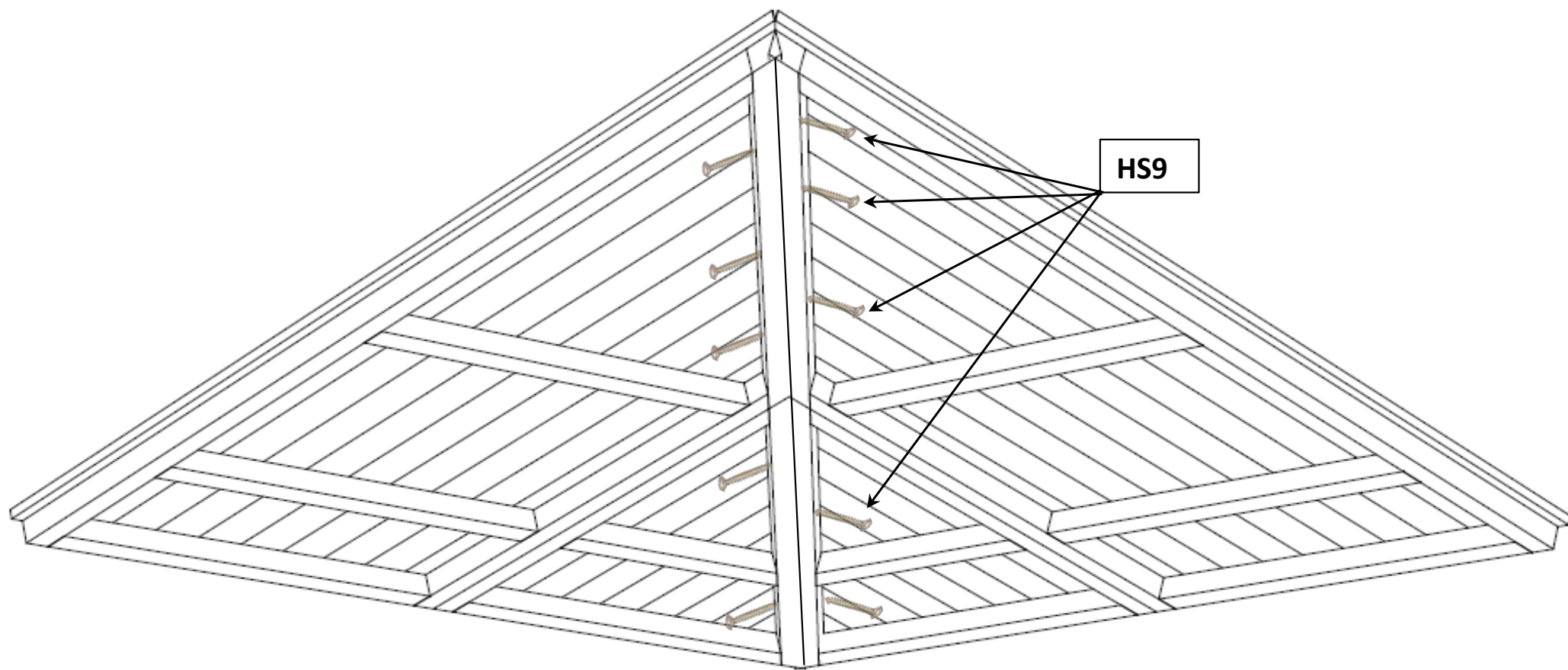

Art. Nr. 407640

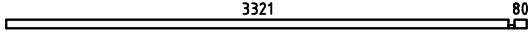
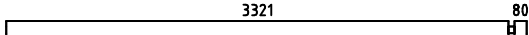
FROM BELOW - VUE DE DESSOUS - ANSICHT VON UNTEN

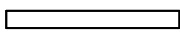
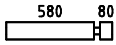
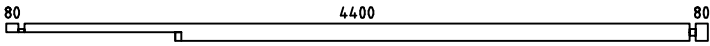
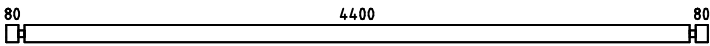
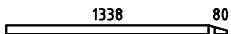
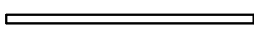
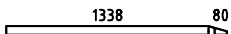
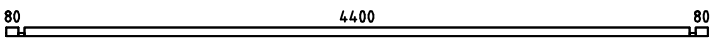
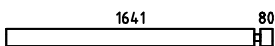
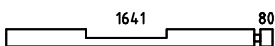
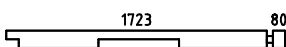
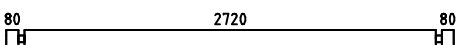
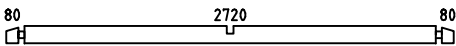
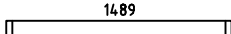
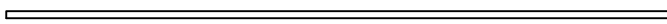
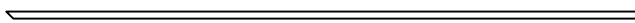
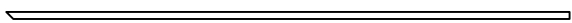
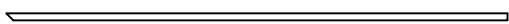
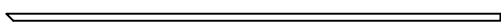
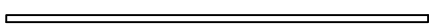

Pos	14.01.2015	Piecelist - Stücklist - Liste des composants Art.Nr. 407640	11/14	Q.	P. (mm)	L. (mm)
001				1	40x57	3441
002				1	40x114	3441
003				27	40x114	526
004				14	40x114	1145
005				27	40x114	700
006				1	40x114	4640
007				18	40x114	4640
008	▫			2	40x57	1458
009	▫			2	40x57	1636
010	▫			2	40x57	1458
011				1	40x57	4640
012				1	40x114	1761
013				1	40x114	1761
014				1	40x114	1843
015				18	40x114	2960
016	▫			2	40x114	2960
017				1	40x114	1489
IAR5		FOUNDATION - FUNDAMENT - FONDATION 		5	45x45	4380
IAR6		FOUNDATION - FUNDAMENT - FONDATION 		1	45x45	4184
IAR7		FOUNDATION - FUNDAMENT - FONDATION 		1	45x45	3727
IAR8		FOUNDATION - FUNDAMENT - FONDATION 		1	45x45	3314
IAR9		FOUNDATION - FUNDAMENT - FONDATION 		1	45x45	3269
IAR4		FOUNDATION - FUNDAMENT - FONDATION 		1	45x45	2790
IAR2		FOUNDATION - FUNDAMENT - FONDATION 		1	45x45	1698
IAR3		FOUNDATION - FUNDAMENT - FONDATION 		1	45x45	1634

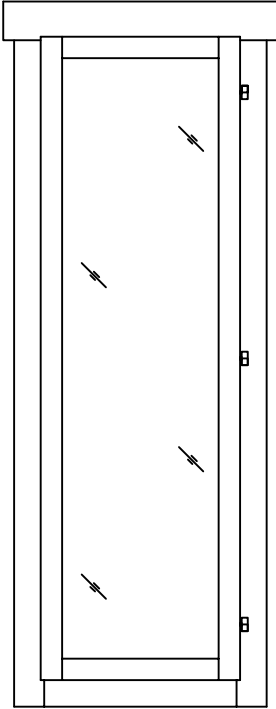
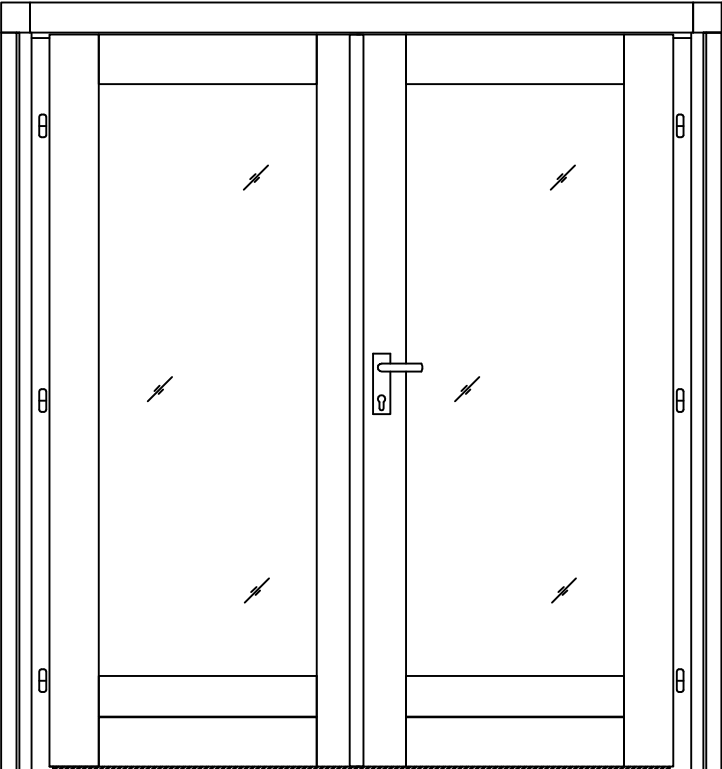
Pos	Piecelist - Stücklist - Liste des composants Art.Nr. 407640	14/14	Q.	P. (mm)	L. (mm)
	<p>WINDOW - FENSTER - FENETRE 525x1560 DGP</p> <p style="text-align: right;">AK.1.100.PVP.j</p> 	3			
	<p>DOOR - TÜR - PORTE 1494x1736 DGP</p> <p style="text-align: right;">TUK.1.100.PVP.MM.5c</p> 	1			