

Jubilee 44
Art. Nr. 4411202
1/7

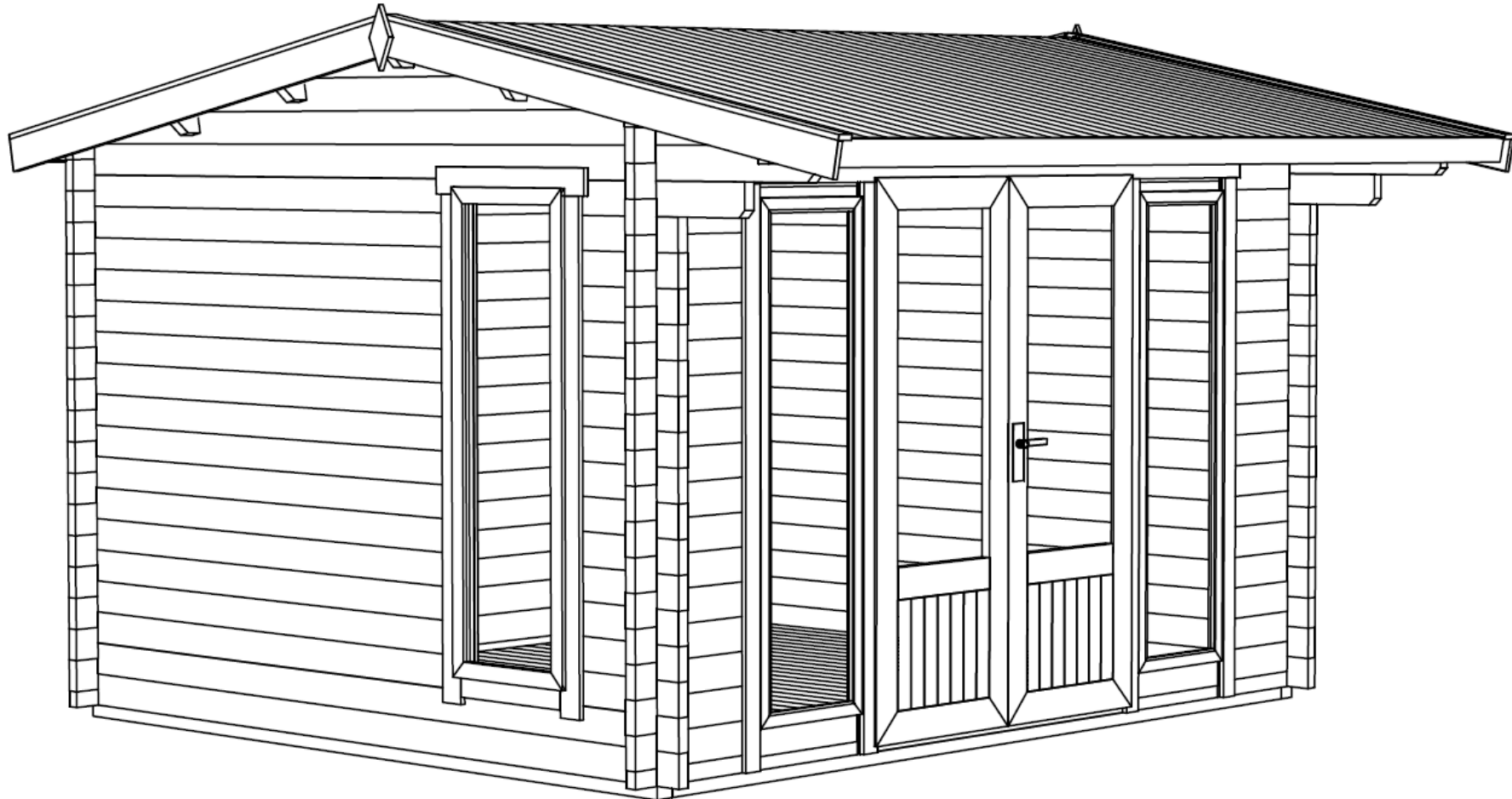

44x114
13.03.2013

GROUNDPLAN - GRUNDPLAN - PLAN DE MASSE

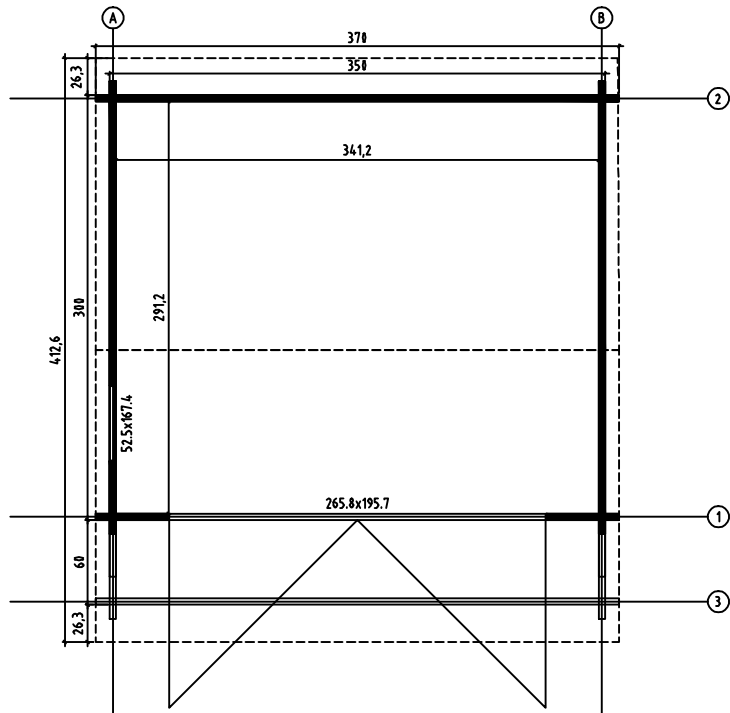



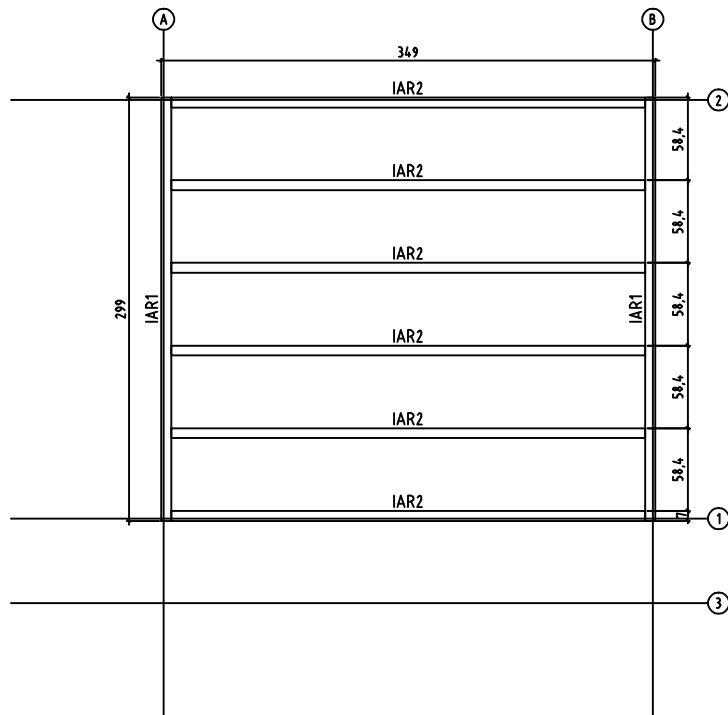



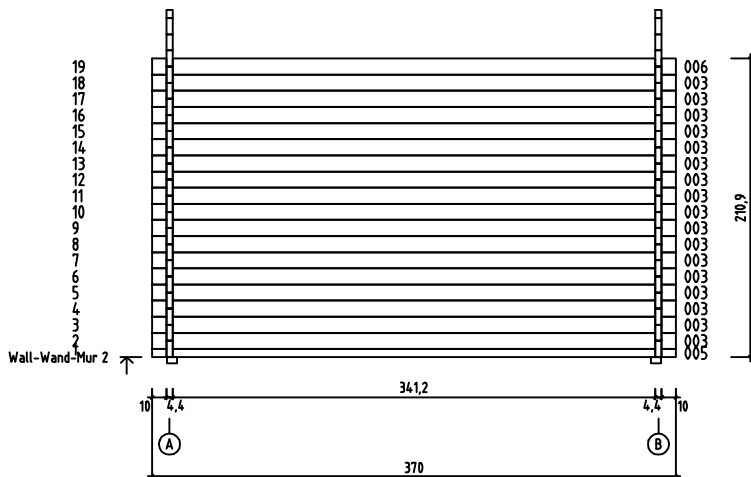
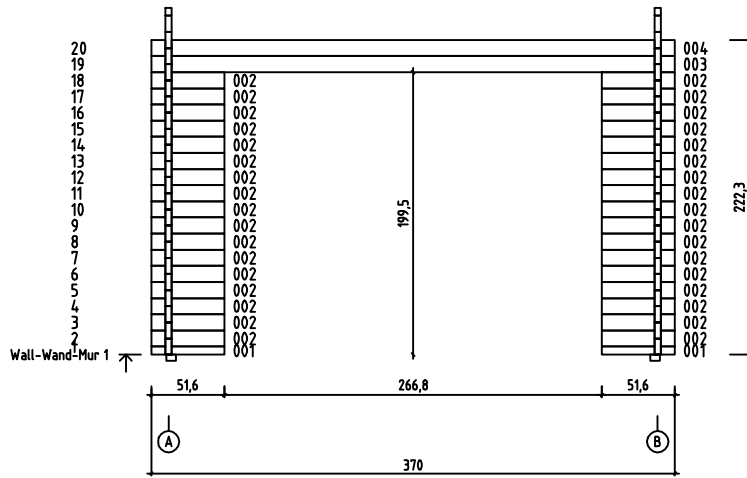
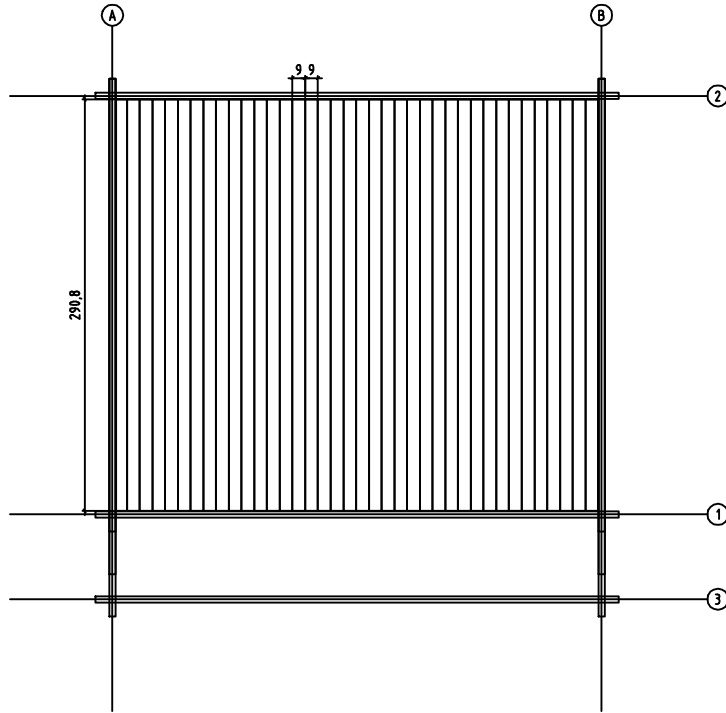







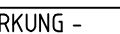
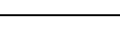
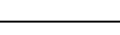

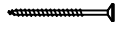
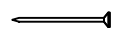

FOUNDATION - FUNDAMENT - FONDATION

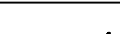

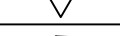
FLOOR BOARDS - FUSSBODENBRETTER - PLAN POSE PLANCHER

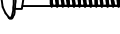

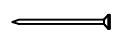
Pos	13.03.2013	Piecelist - Stücklist - Liste des composants Art. Nr. 4411202	5/7	Q.	P (mm)	L (mm)
001				2	44x57	516
002				48	44x114	516
003				18	44x114	3700
004				1	44x120	3700
005				1	44x57	3700
006				2	44x120	3700
007				18	44x114	3200
008				15	44x114	2151
009				1	44x114	816
010				2	44x114	3800
015				1	44x114	3500
WA-1				1		
WB-1				1		
IAR2		FOUNDATION - FUNDAMENT - FONDATION		6	70x45	3350
IAR1		FOUNDATION - FUNDAMENT - FONDATION		2	70x45	2990
PR1		ROOF BEAM - DACHBALKEN - PANNE DE TOIT 3412		1	44x140	3700
A-PR1		ROOF BEAM - DACHBALKEN - PANNE DE TOIT 3412		3	44x140	3700
	FLOOR BOARDS - FUSSBODENBRETT - LAME DE PLANCHER			38	90x28	2908
	ROOF BOARDS - DACHBRETT - VOLIGES			84	90x18	2100
FL	FLOOR FILLET-FUSSBODENLEISTE - CORNIERE DE FINITION DU PLANCHER				18x18	12.63
DPL	ROOFING FELT FILLET - DACHPAPPENLEISTE - BAGUETTE DE FIXATION DU FEUTRE BITUMEUX			4	18x58	2150
TB	EAVES BOARD - TRAUFBRETT - BANDEAU DE TOIT			2	18x90	3700
DRV	ROOF EDGE REINFORCEMENT - DACHRANDVERSTÄRKUNG - CORNIERE DE RENFORT DE BORD DE TOIT			2	28x34	3700
KFS	STORM PROTECTION - STURMLEISTE - LATTE ANTI-TEMPETE			4	22x45	2100
GL	GABLE MOULDING - GIBELLEISTE - PLANCHE DE RIVE			4	18x120	2150

Pos	13.03.2013	Piecelist - Stücklist - Liste des composants Art. Nr. 4411202	6/7	Q.	P (mm)	L (mm)
FS		WINDOW HANDLE FITTINGS-FENSTERGRIFF - POIGNÉE D'OUVERTURE DE FENETRE		2		
		SCREW FOR GABLE SEGMENT - SCHRAUBEN FÜR DECKBLATT - VIS POUR FIXATION LOSANGE DE FINITION		4	3.5X35	
HS16		SCREW FOR GABLE MOULDING - SCHRAUBEN FÜR GIEBELLEISTE - VIS DE FIXATION POUR PLANCHE DE RIVE		32	3.5X50	
HS3		SCREW FOR DOOR FILLET - SCHRAUBE ZUR BEFESTIGUNG TÜRLEISTE - VIS D'ASSEMBLAGE DU CADRE DE PORTE		5	3X30	
HS32		SCREW FOR EAVES BOARDS - SCHRAUBEN FÜR TRAUFBRETTNER - VIS DE FIXATION POUR BANDEAU DE TOIT		16	4X40	
HS26		SCREW FOR ROOF EDGE REINFORCEMENT - SCHRAUBEN FÜR DACHRANDVERSTÄRKUNG - VIS POUR RENFORT DE BORD DE TOIT		16	4X40	
HS39		SCREW FOR FUNDAMENT - SCHRAUBEN ZUR BEFESTIGUNG FUNDAMENT - VIS POUR FONDATION		12	5X120	
HS43		SCREW FOR ROOF BEAMS - SCHRAUBEN FÜR DACHBALKEN - VIS POUR PANNE DE TOIT		14	5x120	
HS42		SCREW FOR GABLE - SCHRAUBEN FÜR GIEBEL - VIS POUR FIXATION DES PIGNONS		16	5x120	
HS40		SCREW FOR 1. WALL BEAM - SCHRAUBE FÜR 1. BOHLENREIHE - VIS DE FIXATION DES FONDATIONS		7	5X90	
HS41		SCREW FOR DOOR JAMB - SCHRAUBE FÜR TÜRRAHMEN - VIS DE FIXATION POUR MONTANT DE PORTE		8	5X90	
NFF		ZN NAIL FOR FLOOR FILLET - ZN NÄGEL FÜR FUSSBODENLEISTE - POINTE POUR CORNIERE DE FINITION DU PLANCHER		25	1.4X40	
SH44		HAMMER BLOCK - SCHLAGHOLZ - CALLE DE FRAPPE		1		
		SCREW FOR DOORSTEP - SCHRAUBEN FÜR TÜRSCHWELLE - VIS DE FIXATION DU SEUIL DE PORTE		3	4.5X65	
NFD		ZN NAIL FOR ROOFING FELT FILLET - ZN NÄGEL FÜR DACHPAPPENLEISTE - POINTE POUR BAGUETTE FIXATION FEUTRE BITUMEUX		20	2X40	
TS		BOLT FOR WINDOW HANDLE FITTINGS - BOLZEN FÜR FENSTERGRIFF BESCHLAG BOULON POUR POIGNÉE D'OUVERTURE DE FENETRE		4		
GS		GABLE SEGMENT-DECKBLATT - LOSANGE DE FINITION		2		
SFS		NUT FOR STORM PROTECTION - SCHRAUBENMUTTER FÜR STURMLEISTE - ÉCROU POUR LAME ANTI-TEMPETE		8		
BFS		BOLT FOR STORM PROTECTION - BOLZEN FÜR STURMLEISTE - VIS POUR LAME ANTI-TEMPETE		8		
DFS		WASHER FOR STORM PROTECTION - DICHTSCHEIBE FÜR STURMLEISTE - RONDELLE POUR LAME ANTI-TEMPETE		8		
		ZN NAIL FOR ROOF - ZN NÄGEL FÜR DACHBRETTNER - POINTE POUR TOIT		356	2.1X50	
		ZN NAIL FOR FLOOR - ZN NÄGEL FÜR FUSSBODENBRETTNER - CLOUS POUR PLANCHER		234	2.1X50	
TS4		SET OF DOOR LOCK COVERS - SCHLOSSBLENDEN - SET DE GARNITURES DE SERRURE DE PORTE		1		
TS2		MALE BOLT HINGE FOR DOOR - TÜRRIEGEL - PARTIE MALE DE CHARNIERE DE PORTE		6	16X44	
		DOOR HANDLE FITTINGS-TÜRGRIF - SET DE GARNITURES DE SERRURE DE PORTE		1		

