

Berkshire 43
4413340
1/13

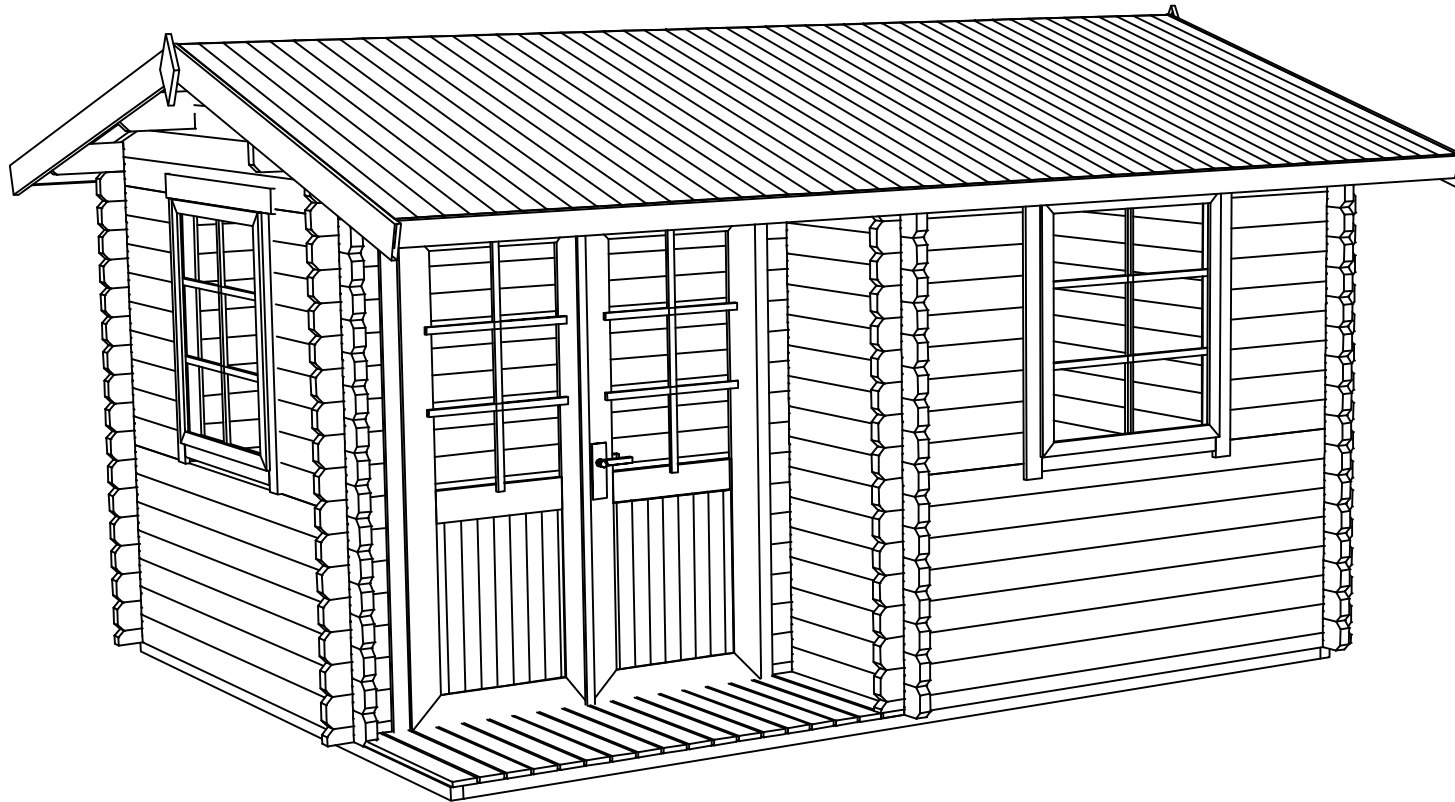

44x114
27.06.2013

GROUNDPLAN - GRUNDPLAN - PLAN DE MASSE

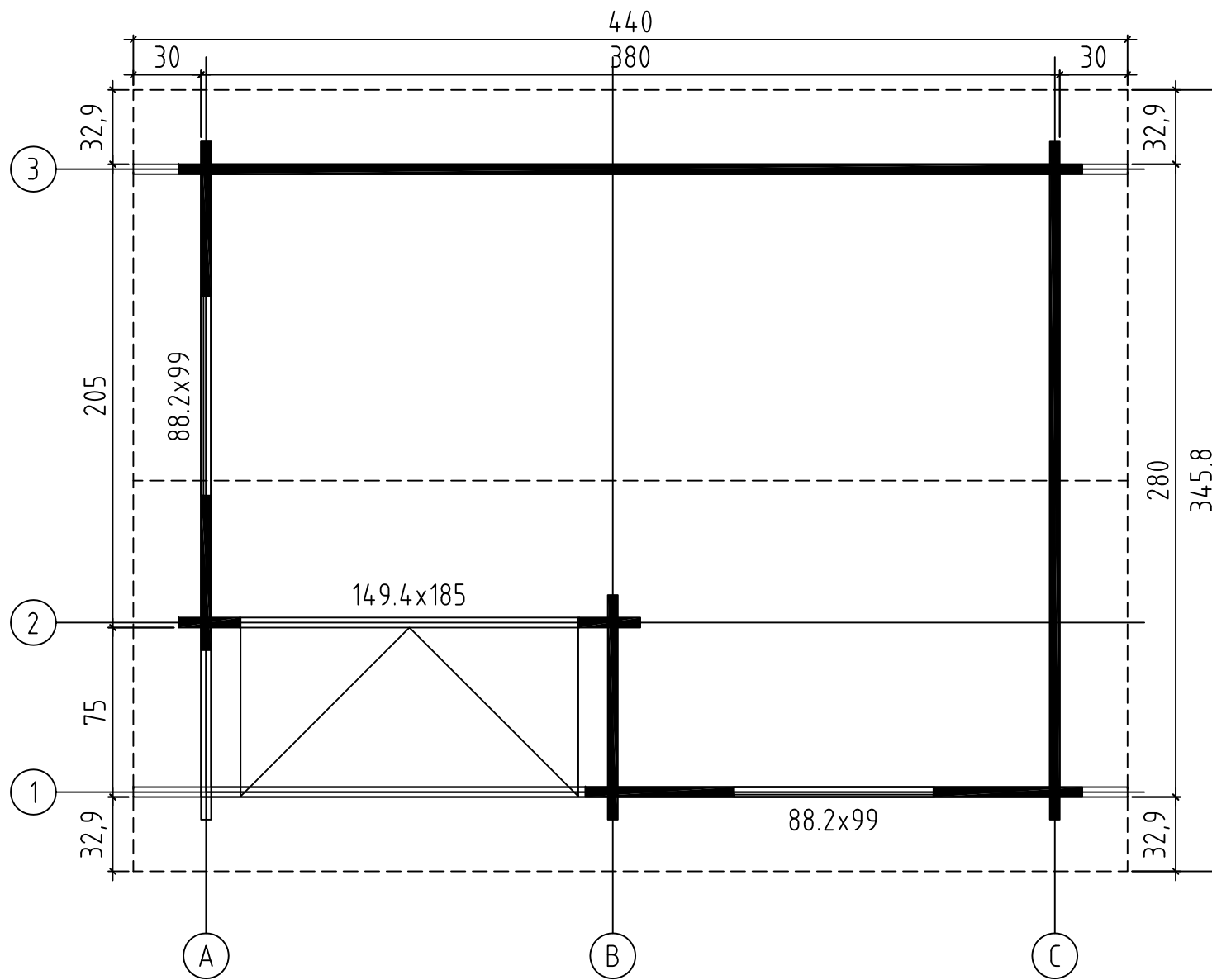

FOUNDATION - FUNDAMENT - FONDATION

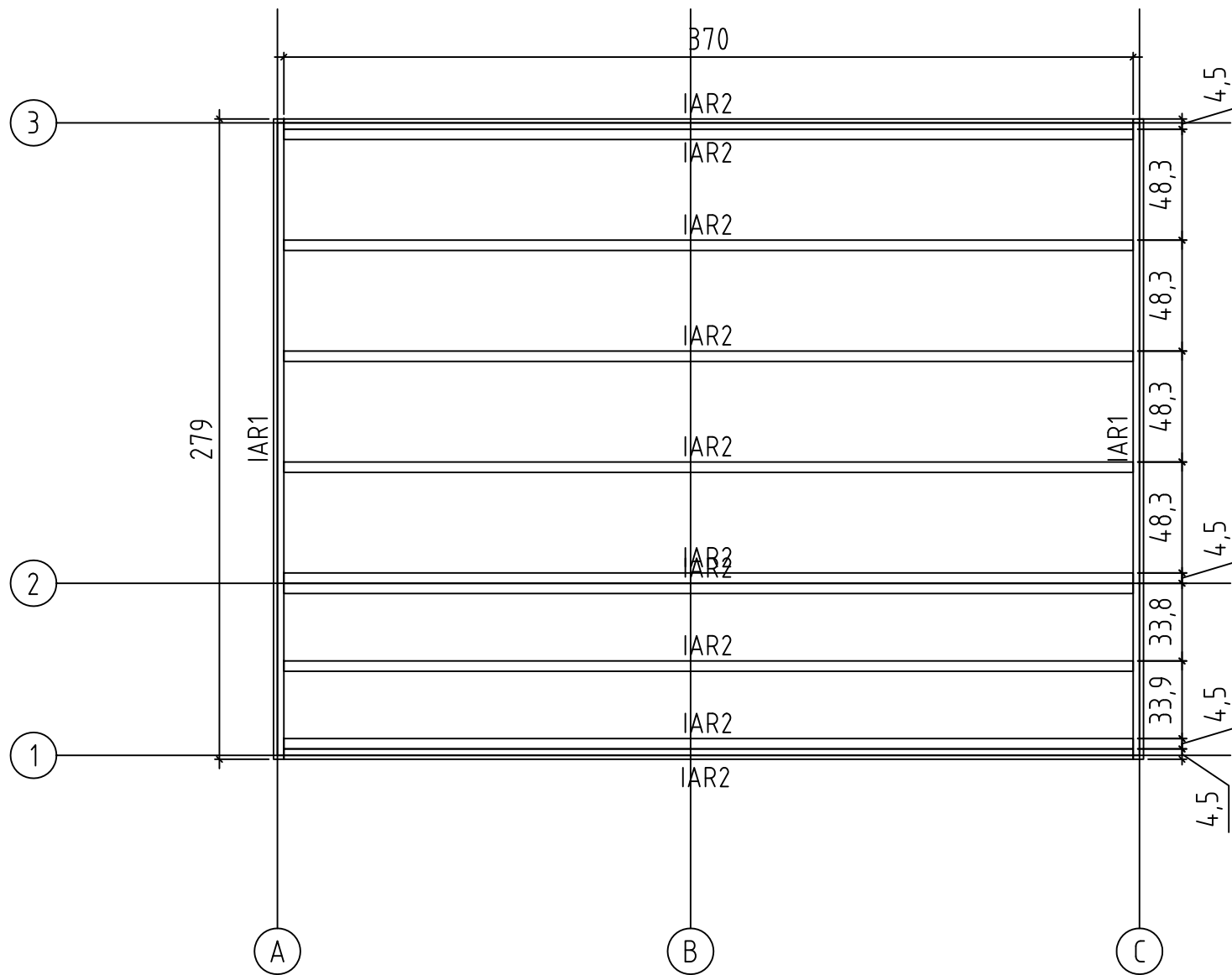

FLOOR BOARDS - FUSSBODENBRETTER - PLAN POSE PLANCHER

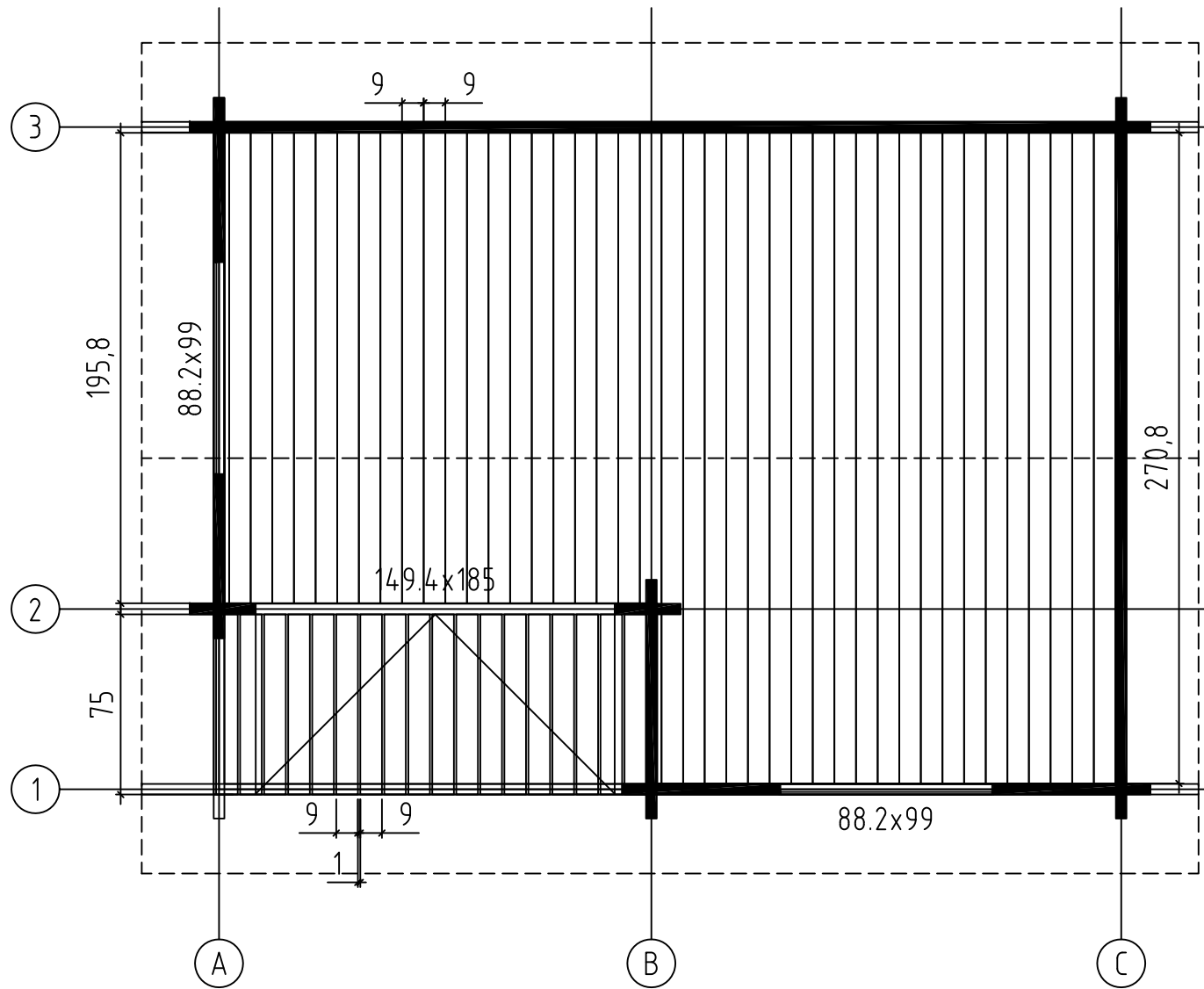

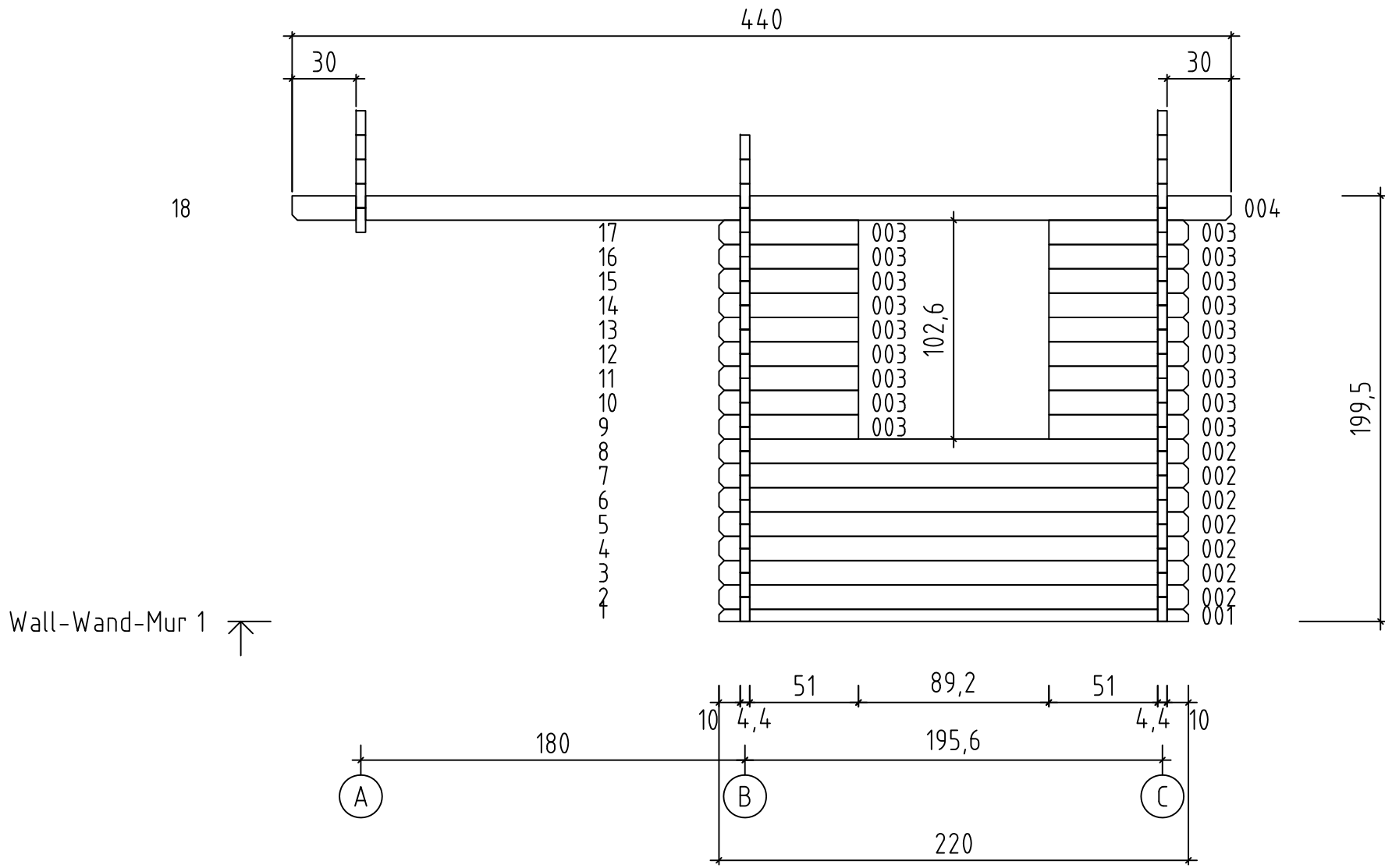

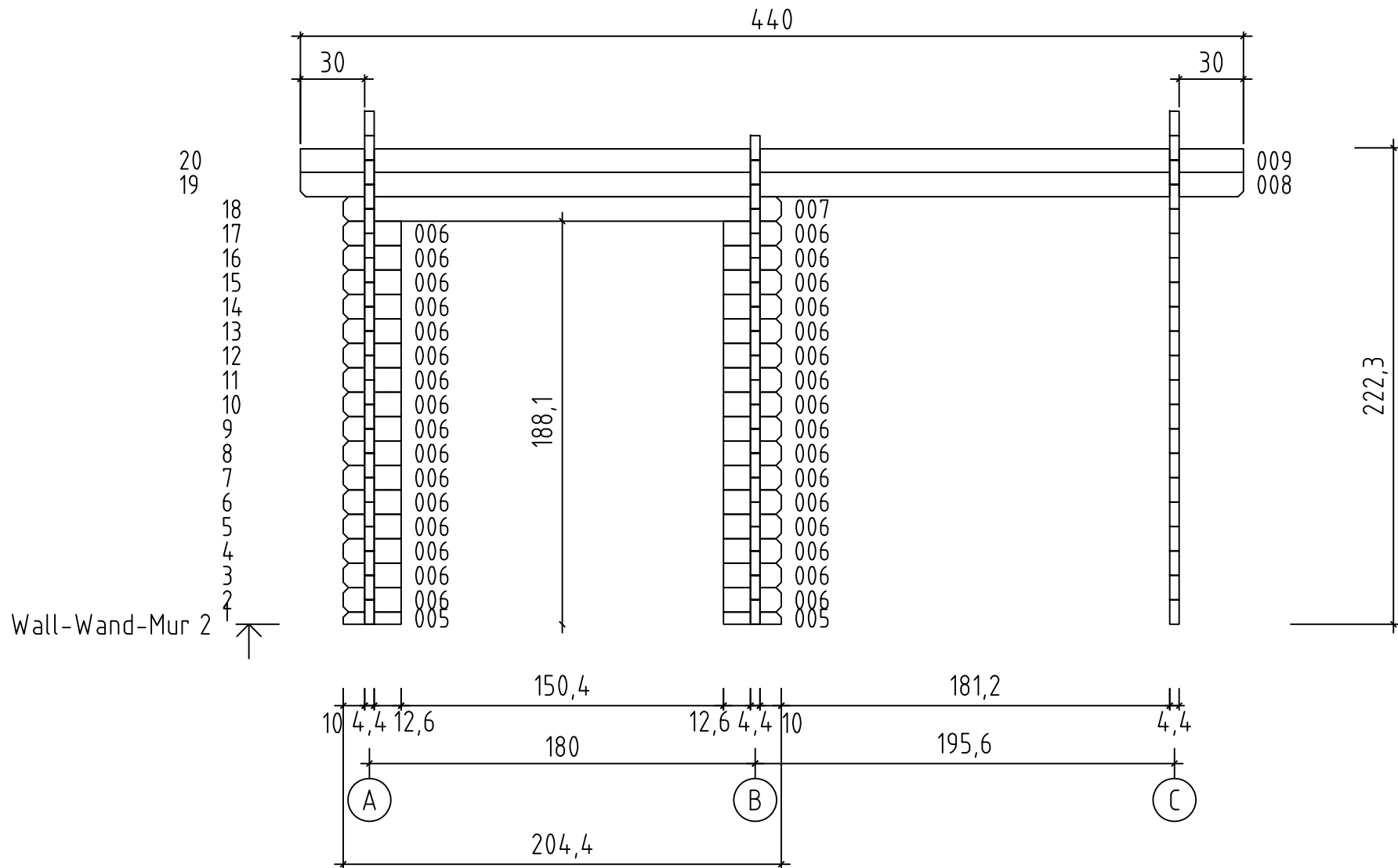

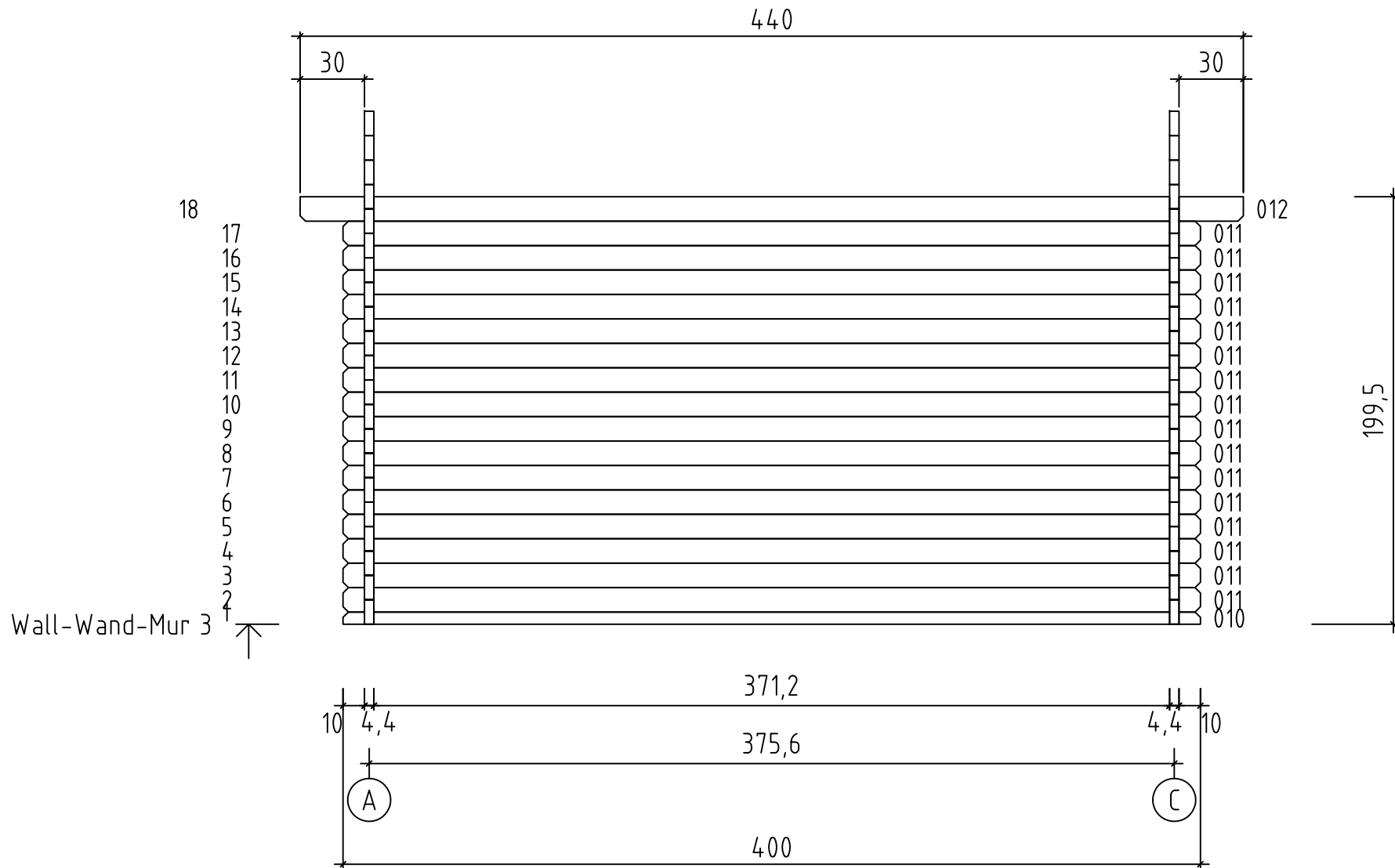

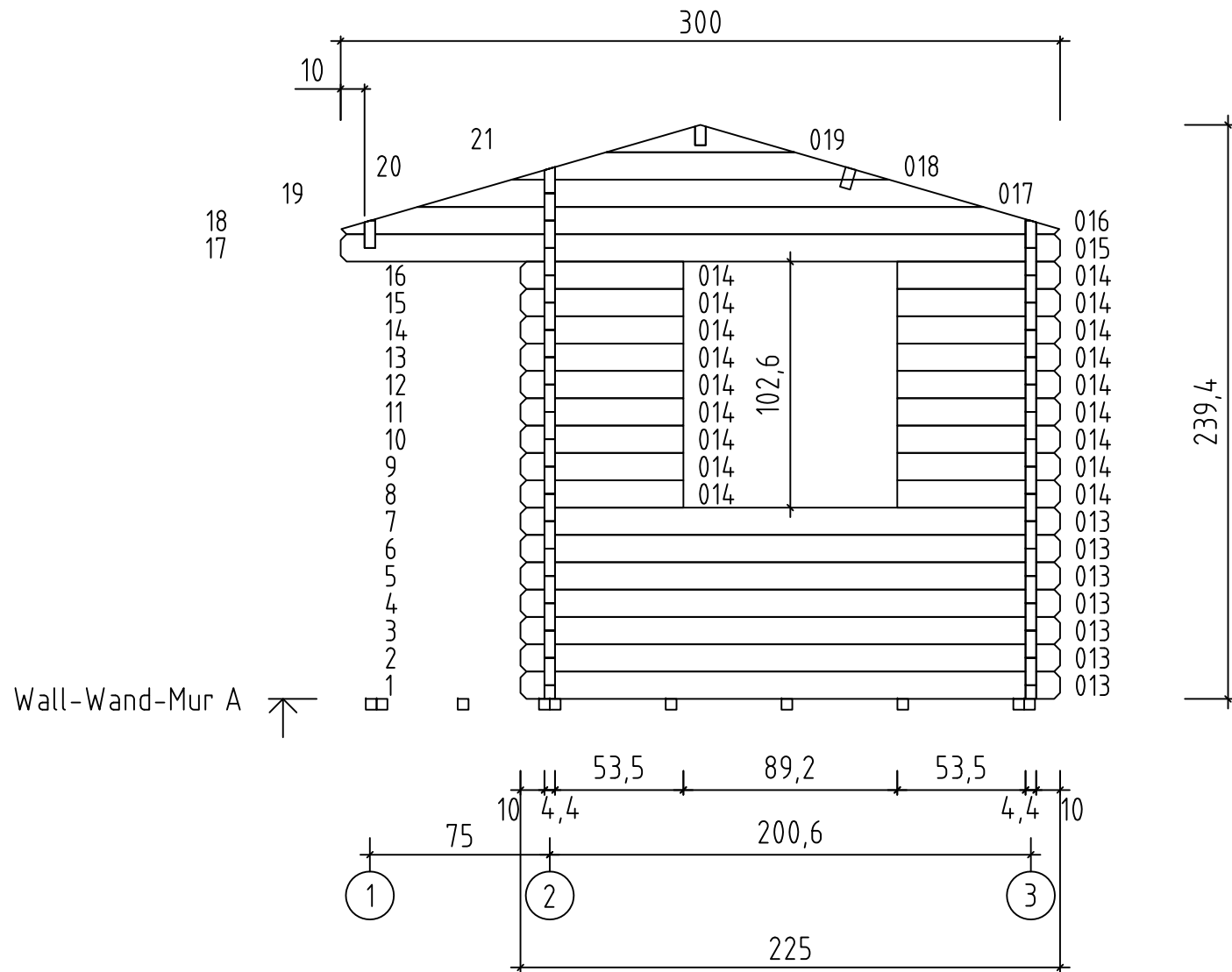

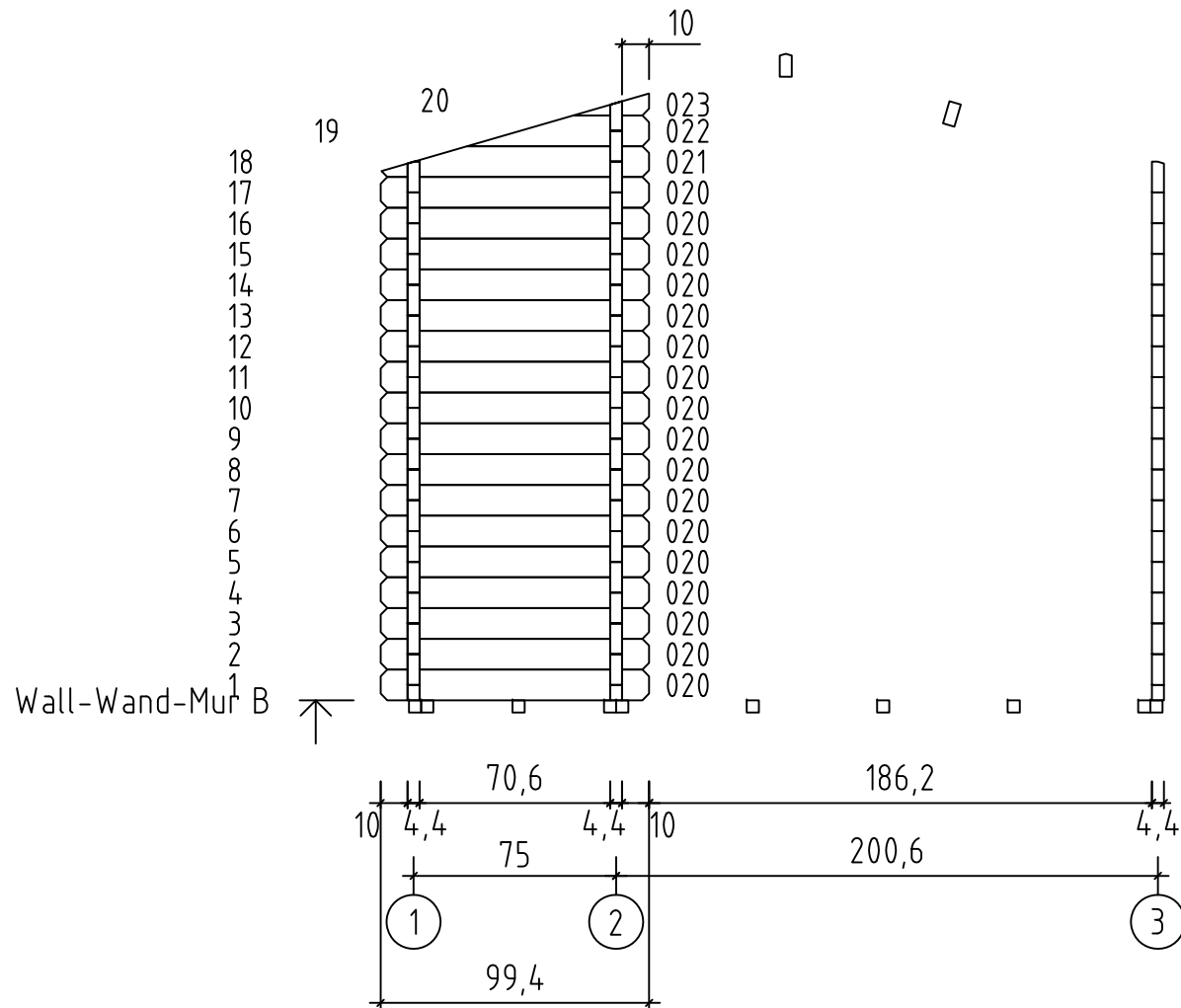

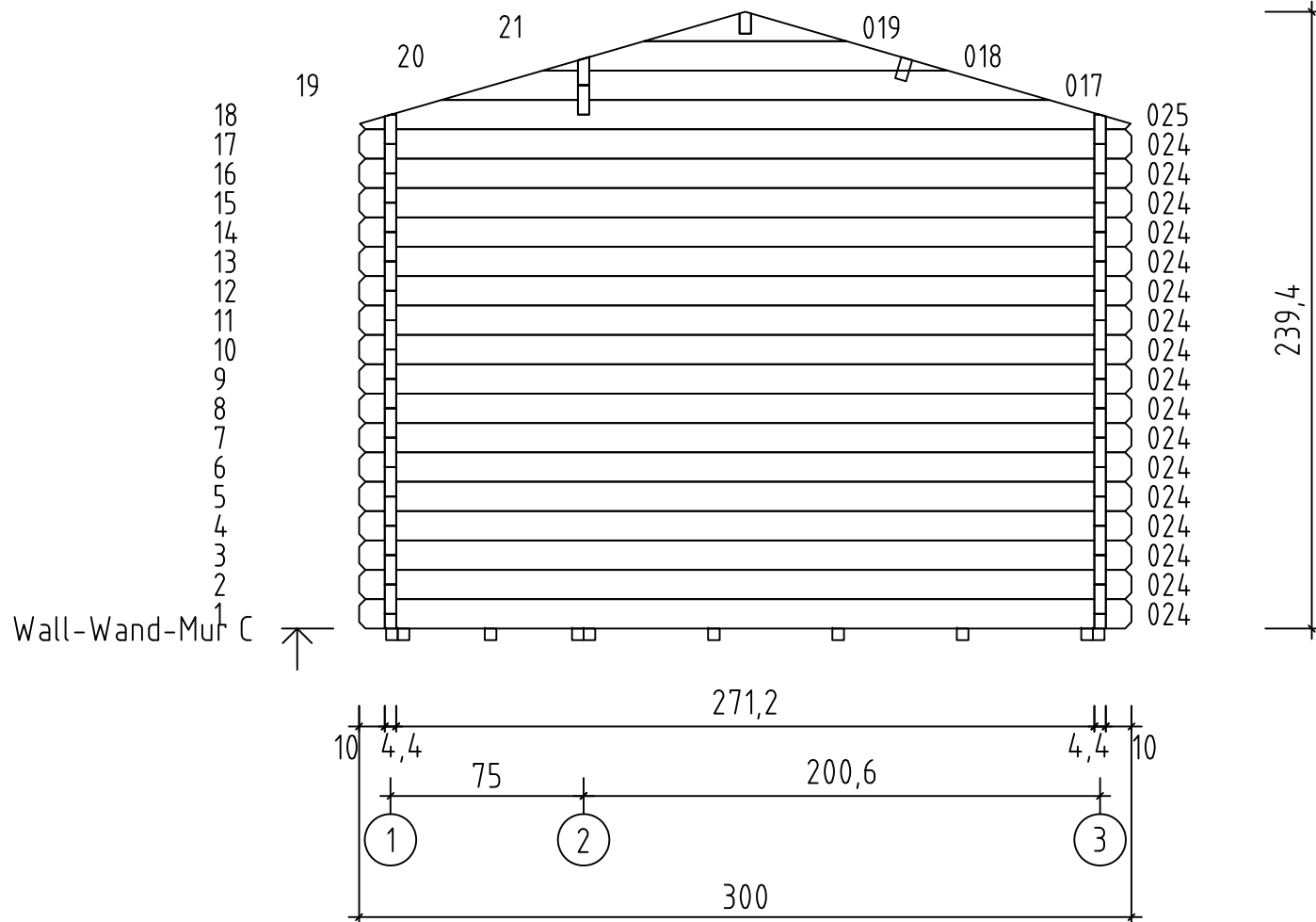

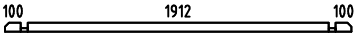
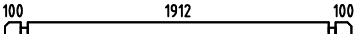
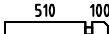
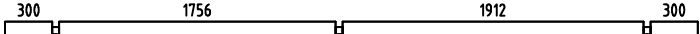
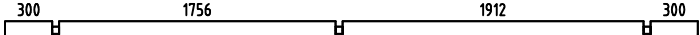

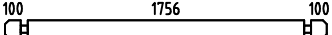
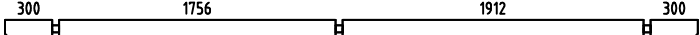
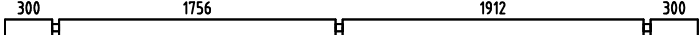
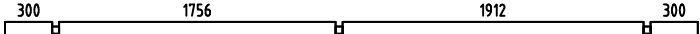
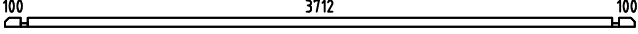
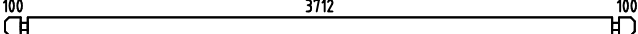
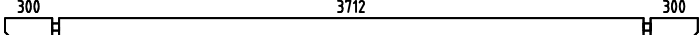
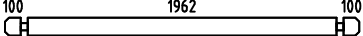
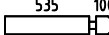
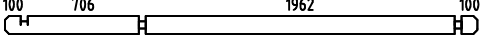
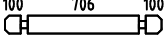
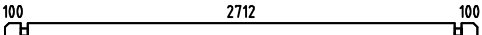
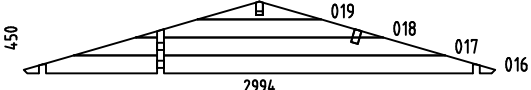
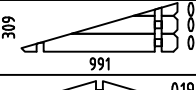
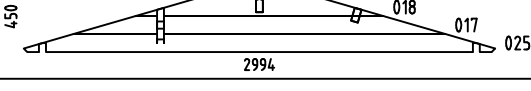
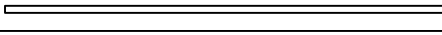
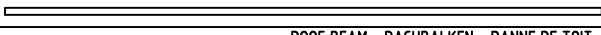
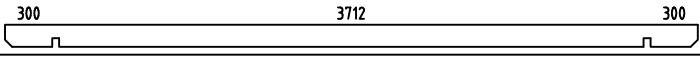
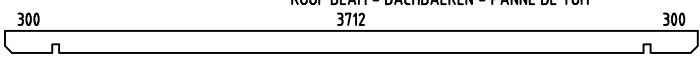



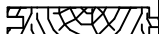

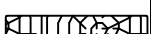

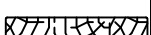

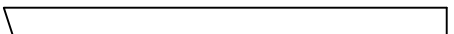

















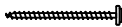

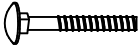
Pos	27.06.2013	Art. Nr. 4413340	11/13	Q.	P (mm)	L (mm)
001				1	44x57	2200
002				7	44x114	2200
003				18	44x114	654
004				1	44x114	4400
004a				1	44x114	4400
005				2	44x57	270
006				32	44x114	270
007				1	44x114	2044
008				1	44x114	4400
009					44x109	4400
009a					44x109	4400
010				1	44x57	4000
011				16	44x114	4000
012				1	44x114	4400
013				7	44x114	2250
014				18	44x114	679
015				1	44x114	3000
020				17	44x114	994
024				17	44x114	3000
WA-1				1		
WB-1				1		
WC-1				1		
IAR1	FOUNDATION - FUNDAMENT - FONDATION 			2	45x45	2790
IAR2	FOUNDATION - FUNDAMENT - FONDATION 			10	45x45	3700
PR11	ROOF BEAM - DACHBALKEN - PANNE DE TOIT 3712 			1	44x140	4400
A.PR21	ROOF BEAM - DACHBALKEN - PANNE DE TOIT 3712 			1	44x140	4400

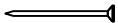
Pos	27.06.2013	Art. Nr. 4413340	12/13	Q.	P (mm)	L (mm)
	FLOOR BOARDS - FUSSBODENBRETTER - LAME DE PLANCHER			22	90x18	2708
	FLOOR BOARDS - FUSSBODENBRETTER - LAME DE PLANCHER			20	90x18	1958
DB	ROOF BOARDS - DACHBRETTER - VOLIGES			98	90x18	1800
SV	TERRACE BOARDS - TERRASSENBRETTER - PLANCHER DE TERRASSE			18	90x19	750
FL	FLOOR FILLET-FUSSBODENLEISTE - CORNIERE DE FINITION DU PLANCHER				18x18	12.83
DPL	ROOFING FELT FILLET - DACHPAPPENLEISTE - BAGUETTE DE FIXATION DU FEUTRE BITUMEUX			4	18x58	1850
TB	EAVES BOARD - TRAUFBRETT - BANDEAU DE TOIT			2	18x90	4400
DRV	ROOF EDGE REINFORCEMENT - DACHRANDVERSTÄRKUNG - CORNIERE DE RENFORT DE BORD DE TOIT			2	28x34	4400
KFS	STORM PROTECTION - STURMLEISTE - LATTE ANTI-TEMPETE			4	22x45	1950
GL	GABLE MOULDING - GIEBELLEISTE - PLANCHE DE RIVE			4	18x120	1850
HS88	SCREW FOR GEORGIAN BARS - SCHRAUBE FÜR SPROSSEN VIS DE BARRES GEORGIENNE			12	2.5x20	
HS12	SCREW FOR GABLE SEGMENT - SCHRAUBEN FÜR DECKBLATT - VIS POUR FIXATION LOSANGE DE FINITION			4	3.5x35	
HS16	SCREW FOR GABLE MOULDING - SCHRAUBEN FÜR GIEBELLEISTE - VIS DE FIXATION POUR PLANCHE DE RIVE			24	3.5x50	
HS3	SCREW FOR DOOR FILLET - SCHRAUBE ZUR BEFESTIGUNG TÜRLEISTE - VIS D'ASSEMBLAGE DU CADRE DE PORTE			5	3x30	
HS32	SCREW FOR EAVES BOARDS - SCHRAUBEN FÜR TRAUFBRETTER - VIS DE FIXATION POUR BANDEAU DE TOIT			20	4x40	
HS26	SCREW FOR ROOF EDGE REINFORCEMENT - SCHRAUBEN FÜR DACHRANDVERSTÄRKUNG - VIS POUR RENFORT DE BORD DE TOIT			20	4x40	
HS43	SCREW FOR ROOF BEAMS - SCHRAUBEN FÜR DACHBALKEN - VIS POUR PANNE DE TOIT			15	5x120	
HS42	SCREW FOR GABLE - SCHRAUBEN FÜR GIEBEL - VIS POUR FIXATION DES PIGNONS			24	5x120	
HS40	SCREW FOR 1. WALL BEAM - SCHRAUBE FÜR 1. BOHLENREIHE - VIS DE FIXATION DES FONDATIONS			9	5x90	
HS39	SCREW FOR FUNDAMENT - SCHRAUBEN ZUR BEFISTIGUNG FUNDAMENT - VIS POUR FONDATION			26	5x90	
HS41	SCREW FOR DOOR JAMB - SCHRAUBE FÜR TÜRRAHMEN - VIS DE FIXATION POUR MONTANT DE PORTE			4	5x90	
NF3	ZN NAIL FOR TERRACE - ZN NÄGEL FÜR TERRASSENBRETTER - POINTE POUR PLANCHER DE TERRASSE			108	2x50	
NFF	ZN NAIL FOR FLOOR FILLET - ZN NÄGEL FÜR FUSSBODENLEISTE - POINTE POUR CORNIERE DE FINITION DU PLANCHER			26	1.4x40	
	ZN NAIL FOR ROOFING FELT FILLET - ZN NÄGEL FÜR DACHPAPPENLEISTE - POINTE POUR BAGUETTE FIXATION FEUTRE BITUMEUX			20	2x40	
TS4	DOOR HANDLE FITTINGS-TÜRGRIF - SET DE GARNITURES DE SERRURE DE PORTE			1		

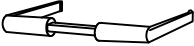
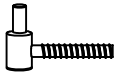
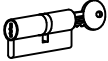
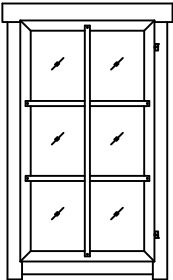
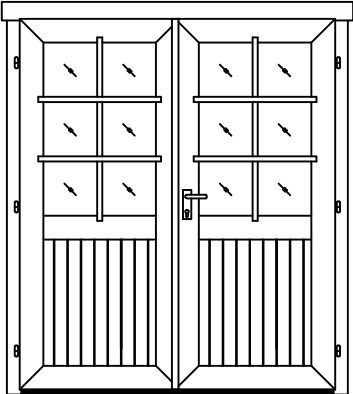
Pos	27.06.2013	Art. Nr. 4413340	13/13	Q.	P (mm)	L (mm)
SH44	HAMMER BLOCK - SCHLAGHOLZ - CALLE DE FRAPPE		1			
MS	SCREW FOR DOORSTEP - SCHRAUBEN FÜR TÜRSCHWELLE - VIS DE FIXATION DU SEUIL DE PORTE		3	4.5x65		
GS	GABLE SEGMENT-DECKBLATT - LOSANGE DE FINITION		4			
SFS	NUT FOR STORM PROTECTION - SCHRAUBENMUTTER FÜR STURMLEISTE - ÉCROU POUR LAME ANTI-TEMPETE		8			
BFS	BOLT FOR STORM PROTECTION - BOLZEN FÜR STURMLEISTE - VIS POUR LAME ANTI-TEMPETE		8			
DFS	WASHER FOR STORM PROTECTION - DICHTSCHEIBE FÜR STURMLEISTE - RONDELLE POUR LAME ANTI-TEMPETE		8			
NF2	ZN NAIL FOR ROOF - ZN NÄGEL FÜR DACHBRETTER - POINTE POUR TOIT		312	2x50		
NH1	ZN NAIL FOR FLOOR - ZN NÄGEL FÜR FUSSBODENBRETTER - CLOUS POUR PLANCHER		297	2x50		
TS3	DOOR HANDLE FITTINGS-TÜRGRIFF - SET DE GARNITURES DE SERRURE DE PORTE		1			
TS2	MALE BOLT HINGE FOR DOOR - TÜRRIEGEL - PARTIE MALE DE CHARNIERE DE PORTE		6			
TS6	CYLINDER LOCK - ZYLINDERSCHLOSS - CYLINDRE DE SERRURE		1			
AK.1.106.PVP.a	WINDOW 882x990 DGP 		2			
TUK.2.056.PVP.MMc	DOOR 1494x1850 DGP 		1			