

*Bora UK*  
*Art. Nr. 4414902*  
*1/8*

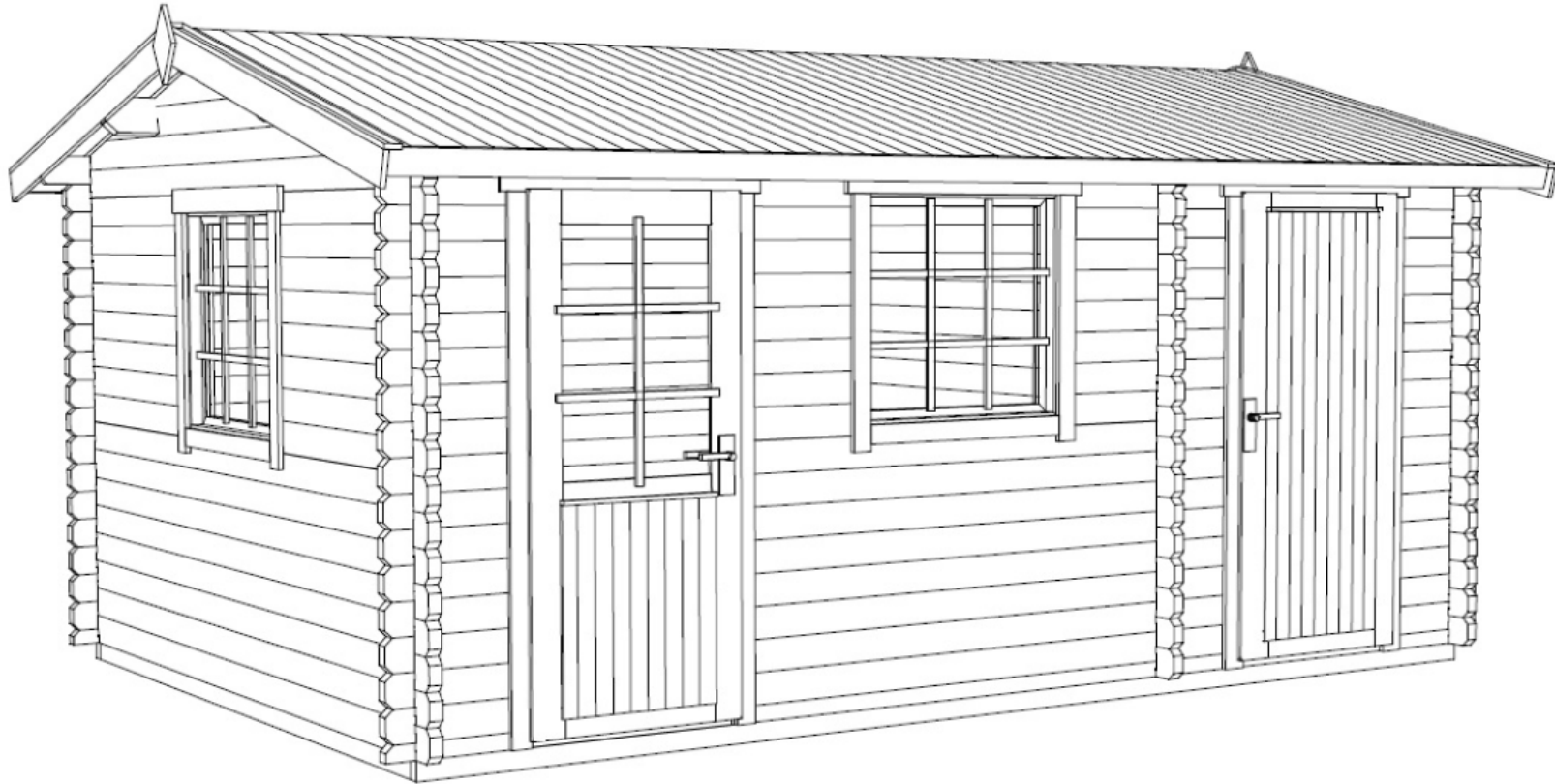

Art. №. 4414902  
GROUNDPLAN - GRUNDPLAN - PLAN DE MASSE

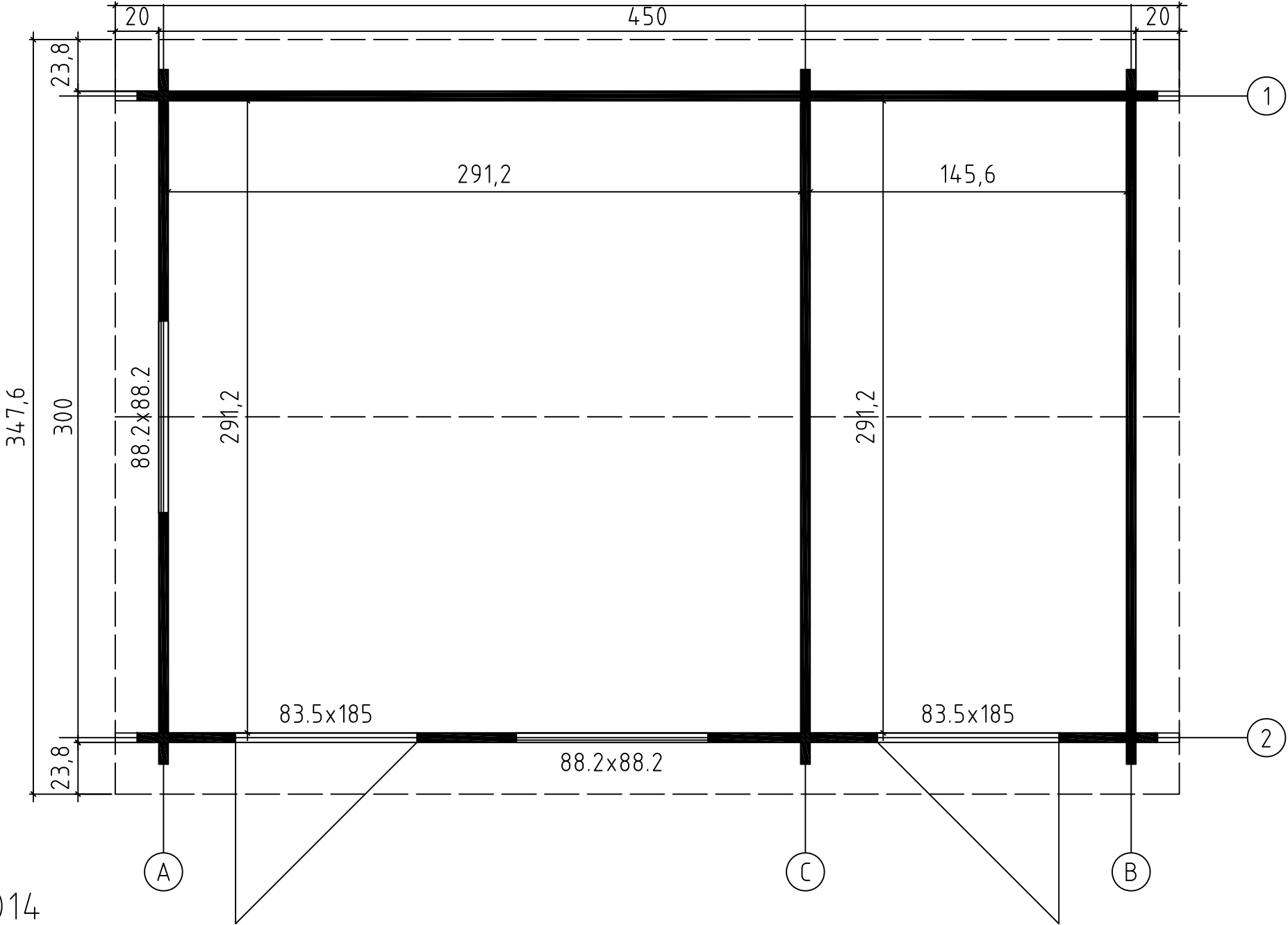

FOUNDATION - FUNDAMENT - FONDATION

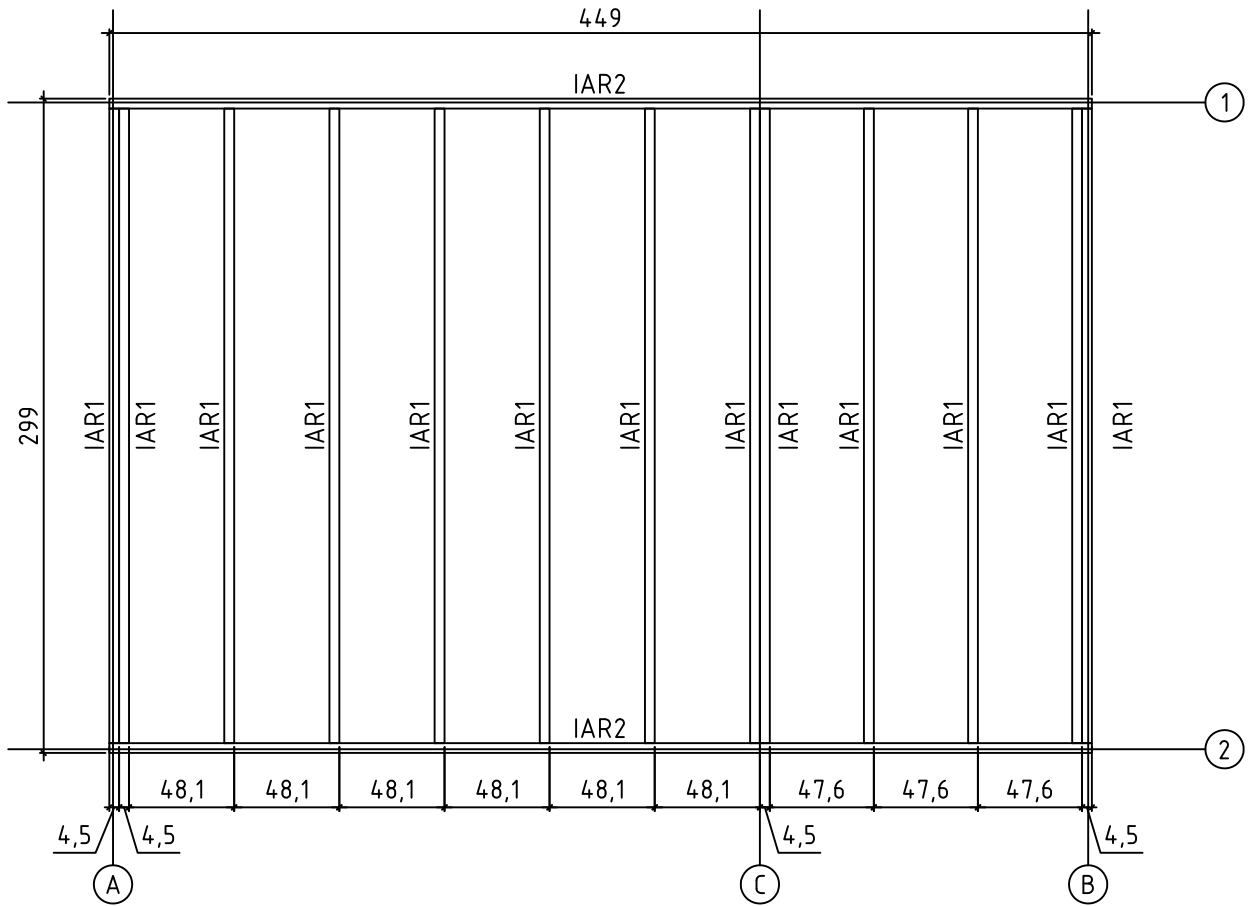



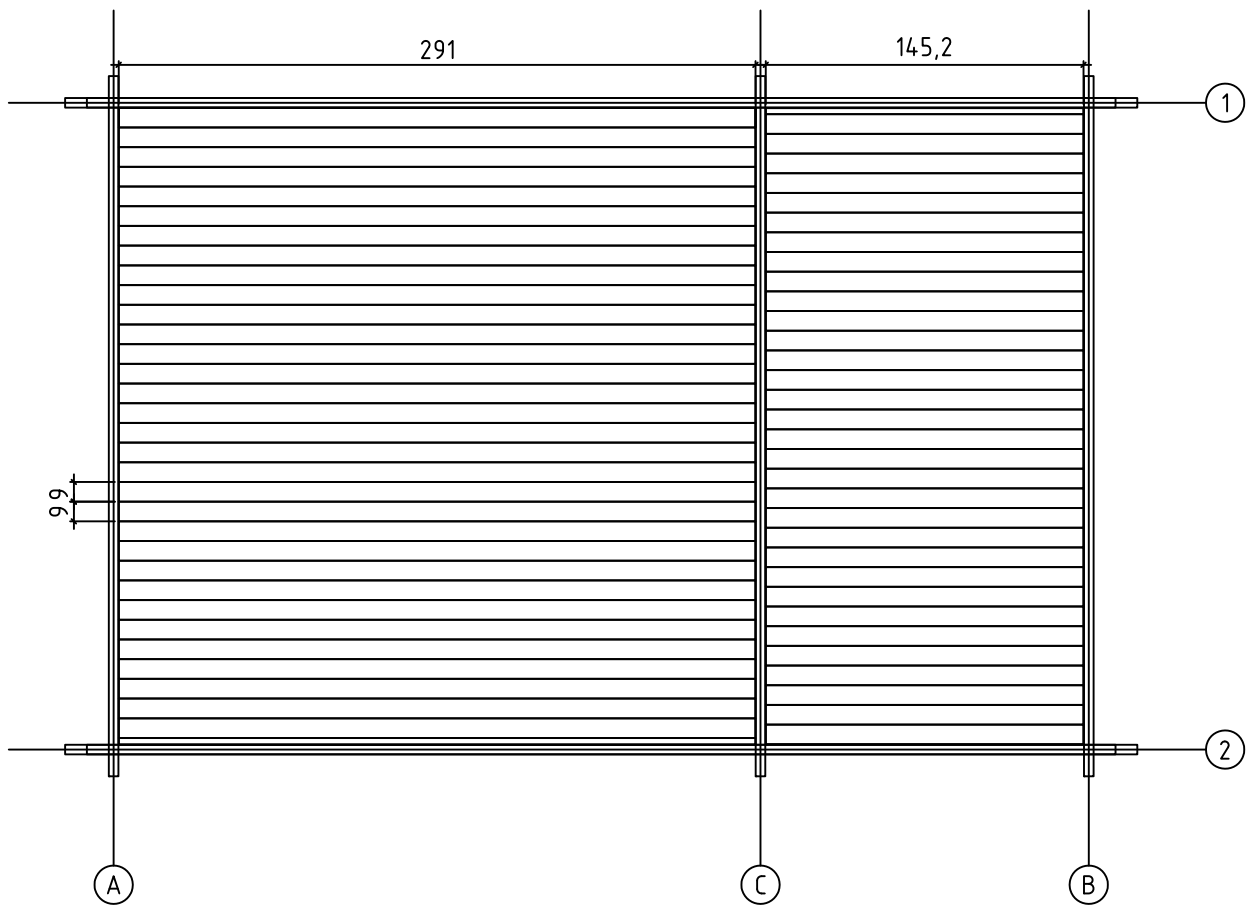

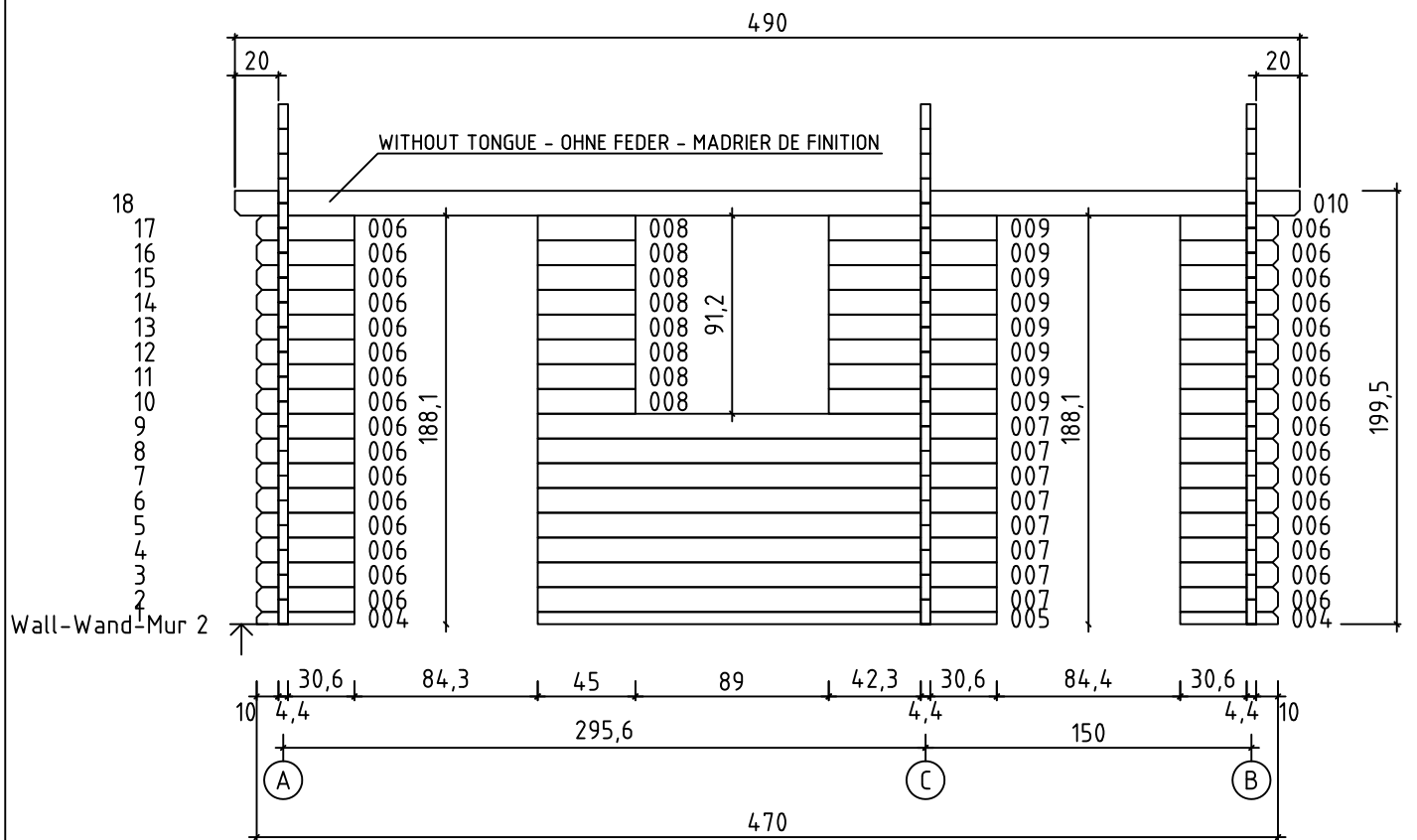
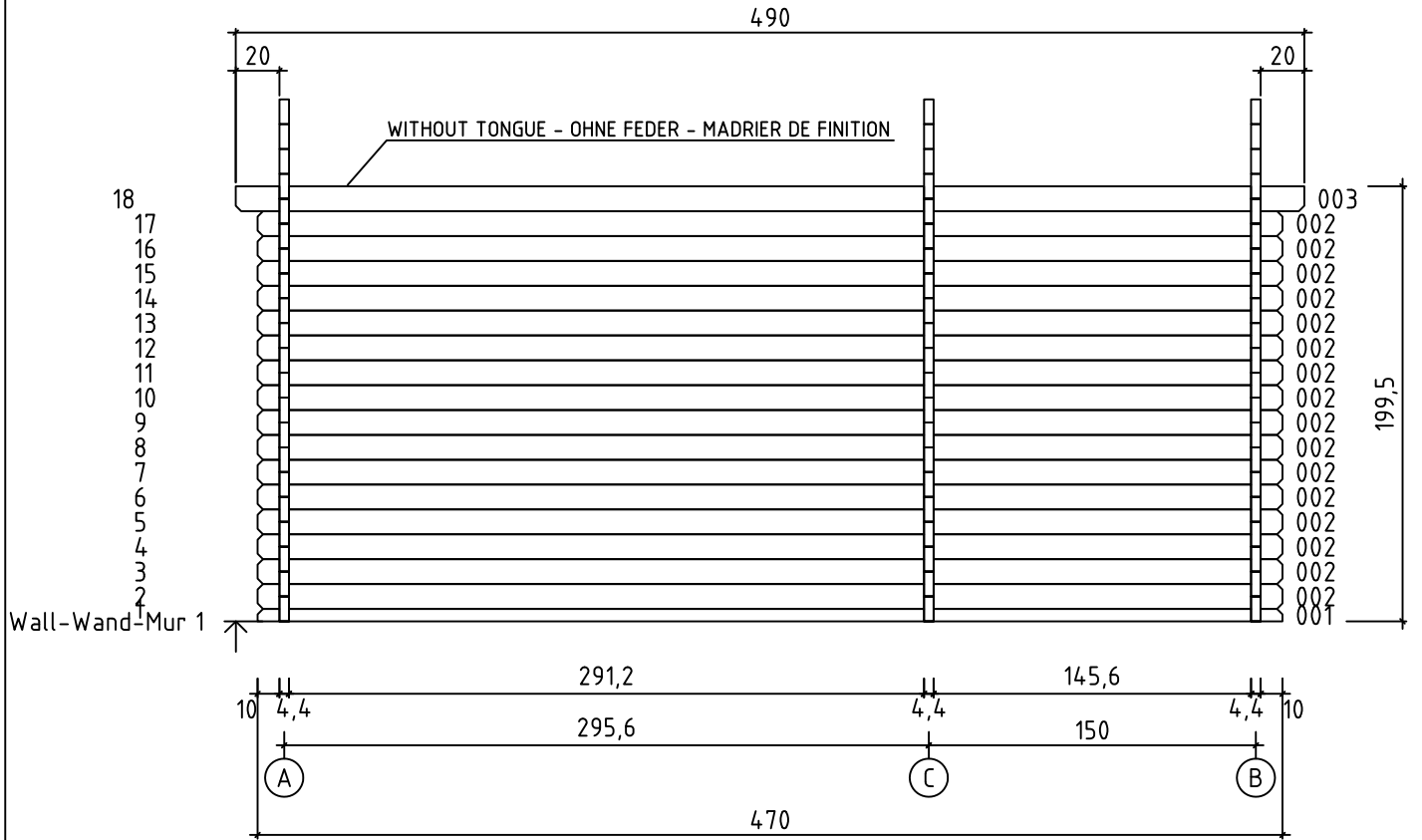

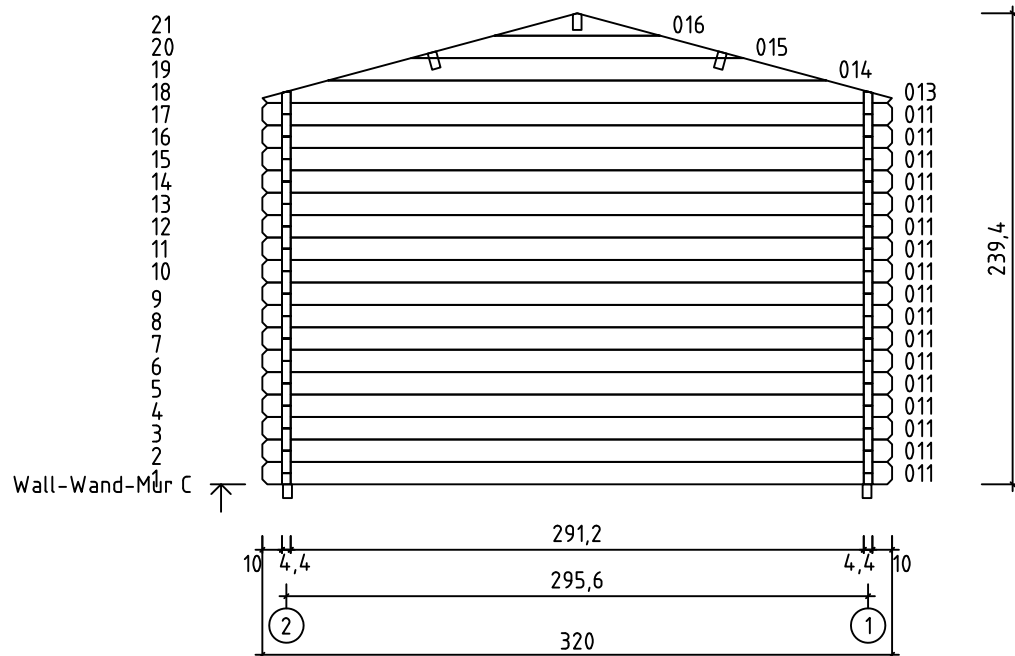
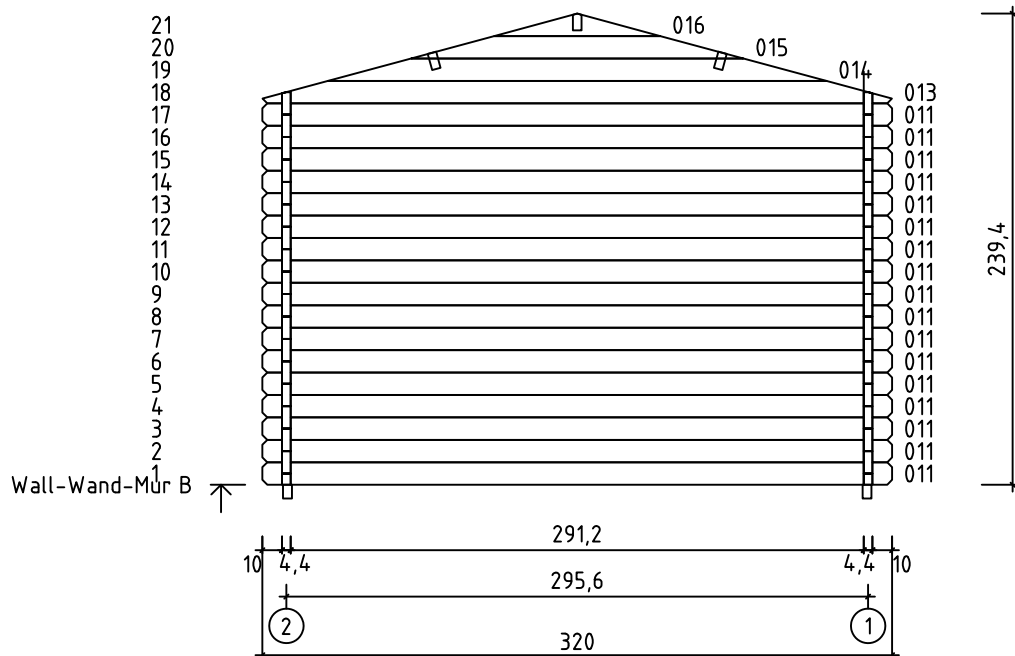
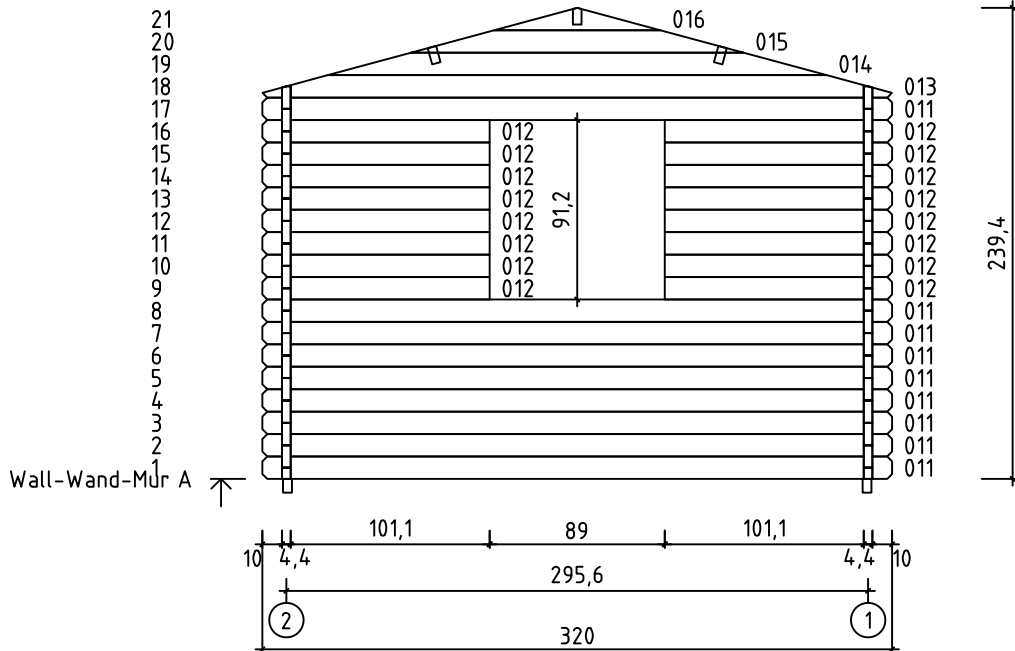





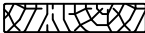

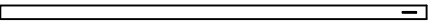

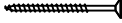
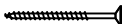
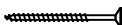



FLOOR BOARDS - FUSSBODENBRETTER - PLAN POSE PLANCHER

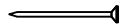

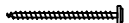

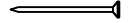

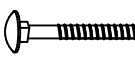
Pos	11.03.2014	Piece list - Stückliste - Liste des pièces Art.Nr. 4414902	6/8	Q.	P (mm)	L (mm)
001				1	44x57	4700
002				16	44x114	4700
003				1	44x120	4900
004				2	44x57	450
005				1	44x57	2113
006				32	44x114	450
007				8	44x114	2113
008				8	44x114	450
009				8	44x114	773
010				1	44x120	4900
011				43	44x114	3200
012				16	44x114	1155
WA-1				1		
WB-1				1		
WC-1				1		
IAR2		FOUNDATION - FUNDAMENT - FONDATION 		2	45x70	4490
IAR1		FOUNDATION - FUNDAMENT - FONDATION 		13	45x70	2900
PR11		ROOF BEAM - DACHBALKEN - PANNE DE TOIT 		1	44x140	4900
PR21		ROOF BEAM - DACHBALKEN - PANNE DE TOIT 		2	44x140	4900
FB		FLOOR BOARDS - FUSSBODENBRETTEN - LAME DE PLANCHER 		33	90x18	2910
FB		FLOOR BOARDS - FUSSBODENBRETTEN - LAME DE PLANCHER 		33	90x18	1452
DB		ROOF BOARDS - DACHBRETTEN - VOLIGES 		110	90x18	1800

Pos	11.03.2014	Piece list - Stückliste - Liste des pièces Art.Nr. 4414902	7/8	Q.	P (mm)	L (mm)
FL	FLOOR FILLET-FUSSBODENLEISTE - CORNIERE DE FINITION DU PLANCHER				18x18	20.36
DPL	ROOFING FELT FILLET - DACHPAPPENLEISTE - BAGUETTE DE FIXATION DU FEUTRE BITUMEUX			4	18x58	1850
TB	EAVES BOARD - TRAUFBRETT - BANDEAU DE TOIT			2	18x70	4900
DRV	ROOF EDGE REINFORCEMENT - DACHRANDVERSTÄRKUNG - CORNIERE DE RENFORT DE BORD DE TOIT			2	28x34	4900
KFS	STORM PROTECTION - STURMLEISTE - LATTE ANTI-TEMPETE			4	22x45	1950
GL	GABLE MOULDING - GIEBELLEISTE - PLANCHE DE RIVE			4	18x120	1850
FS	WINDOW HANDLE FITTINGS-FENSTERGRIFF - POIGNÉE D'OUVERTURE DE FENETRE			2		
	SCREW FOR GEORGIAN BARS - SCHRAUBE FÜR SPROSSEN - VIS DE BARRES GEORGIENNE			22	2.5x20	
HS12	SCREW FOR GABLE SEGMENT - SCHRAUBEN FÜR DECKBLATT - VIS POUR FIXATION LOSANGE DE FINITION			4	3.5x35	
HS16	SCREW FOR GABLE MOULDING - SCHRAUBEN FÜR GIEBELLEISTE - VIS DE FIXATION POUR PLANCHE DE RIVE			24	3.5x50	
HS32	SCREW FOR EAVES BOARDS - SCHRAUBEN FÜR TRAUFBRETT - VIS DE FIXATION POUR BANDEAU DE TOIT			24	4x40	
HS26	SCREW FOR ROOF EDGE REINFORCEMENT - SCHRAUBEN FÜR DACHRANDVERSTÄRKUNG - VIS POUR RENFORT DE BORD DE TOIT			24	4x40	
HS43	SCREW FOR ROOF BEAMS - SCHRAUBEN FÜR DACHBALKEN - VIS POUR PANNE DE TOIT			10	5x120	
HS40	SCREW FOR 1. WALL BEAM - SCHRAUBE FÜR 1. BOHLENREIHE - VIS DE FIXATION DES FONDATIONS			9	5x90	
HS39	SCREW FOR FUNDAMENT - SCHRAUBEN ZUR BEFESTIGUNG FUNDAMENT - VIS POUR FONDATION			30	5x90	
NFF	ZN NAIL FOR FLOOR FILLET - ZN NÄGEL FÜR FUSSBODENLEISTE - POINTE POUR CORNIERE DE FINITION DU PLANCHER			44	1.4x40	
	DOOR HANDLE FITTINGS-TÜRGRIFF - SET DE GARNITURES DE SERRURE DE PORTE			2		
SH44	HAMMER BLOCK - SCHLAGHOLZ - CALLE DE FRAPPE			1		
	SCREW FOR DOORSTEP - SCHRAUBEN FÜR TÜRSCHWELLE - VIS DE FIXATION DU SEUIL DE PORTE			4	4.5x65	
	NUT FOR STORM PROTECTION - SCHRAUBENMUTTER FÜR STURMLEISTE - ÉCROU POUR LAME ANTI-TEMPETE			8		
NFD	ZN NAIL FOR ROOFING FELT FILLET - ZN NÄGEL FÜR DACHPAPPENLEISTE - POINTE POUR BAGUETTE FIXATION FEUTRE BITUMEUX			24	2x40	
TS	BOLT FOR WINDOW HANDLE FITTINGS - BOLZEN FÜR FENSTERGRIFF BESCHLAG - BOULON POUR POIGNÉE D'OUVERTURE DE FENETRE			4		
	BOLT FOR STORM PROTECTION - BOLZEN FÜR STURMLEISTE - VIS POUR LAME ANTI-TEMPETE			8		
GS	GABLE SEGMENT-DECKBLATT - LOSANGE DE FINITION			2		
DFS	WASHER FOR STORM PROTECTION - DICHTSCHEIBE FÜR STURMLEISTE - RONDELLE POUR LAME ANTI-TEMPETE			8		

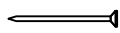
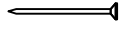
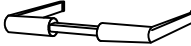
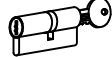
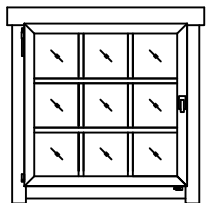
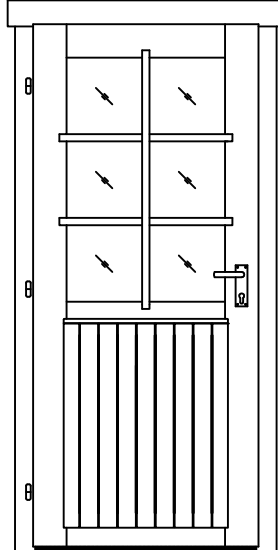
Pos	11.03.2014	Piece list - Stückliste - Liste des pièces Art.Nr. 4414902	8/8	Q.	P (mm)	L (mm)
		ZN NAIL FOR ROOF - ZN NÄGEL FÜR DACHBRETTER - POINTE POUR TOIT		336	2x50	
		ZN NAIL FOR FLOOR - ZN NÄGEL FÜR FUSSBODENBRETTER - CLOUS POUR PLANCHER		374	2x50	
		DOOR HANDLE FITTINGS-TÜRGRIF - SET DE GARNITURES DE SERRURE DE PORTE		2		
TS6		CYLINDER LOCK -ZYLINDERSCHLOSS - CYLINDRE DE SERRURE		2		
		WINDOW - FENSTER - FENETRE 882x882	AK.1.109.PSV.b	DGP	2	
						
		DOOR - TÜR - PORTE 835x1850	UK.2.056.PVV.MMWa	DGP	1	
						
		DOOR - TÜR - PORTE 835x1850	UL.2.100.IVP.MMWa	DGP	1	
		