

Java UK
Art. Nr. 4415811
1/12

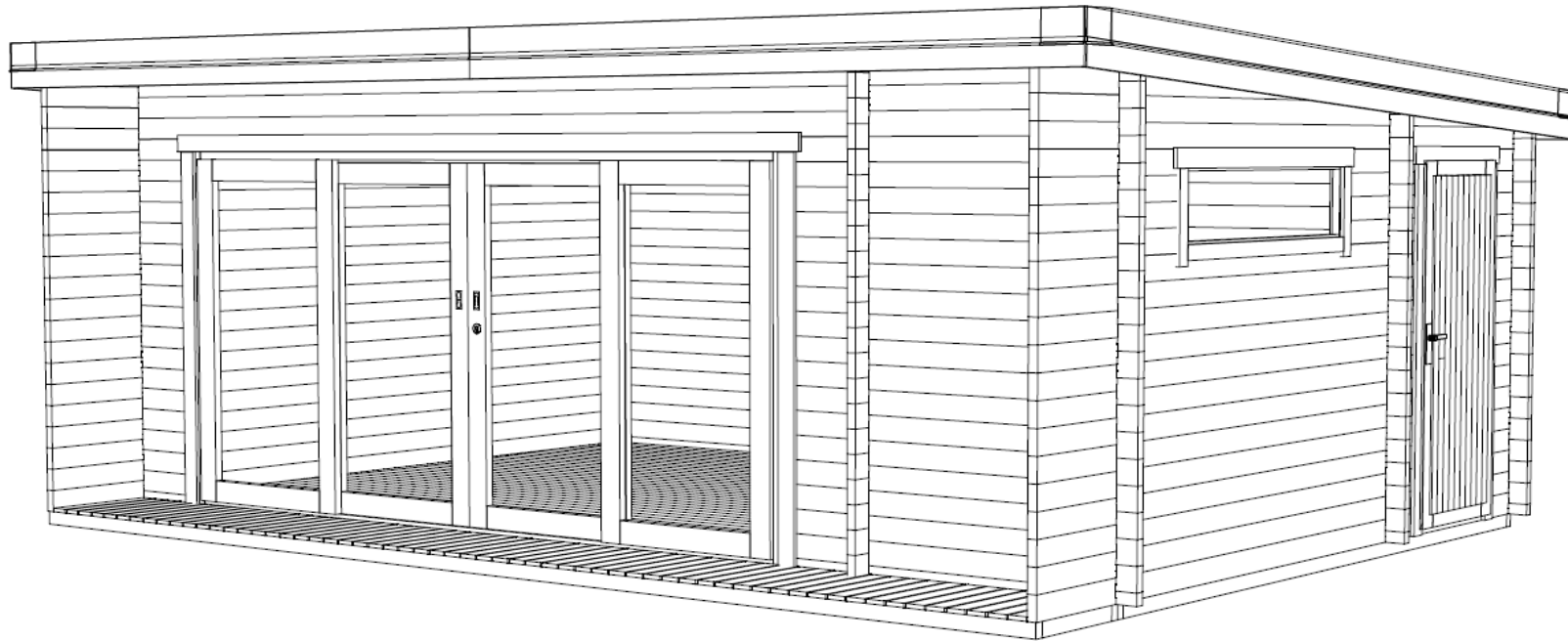

FLOOR BOARDS - FUSSBODENBRETTER - LAME DE PLANCHER
TERRACE BOARDS - TERRASSENBRETTER - PLANCHER DE TERRASSE

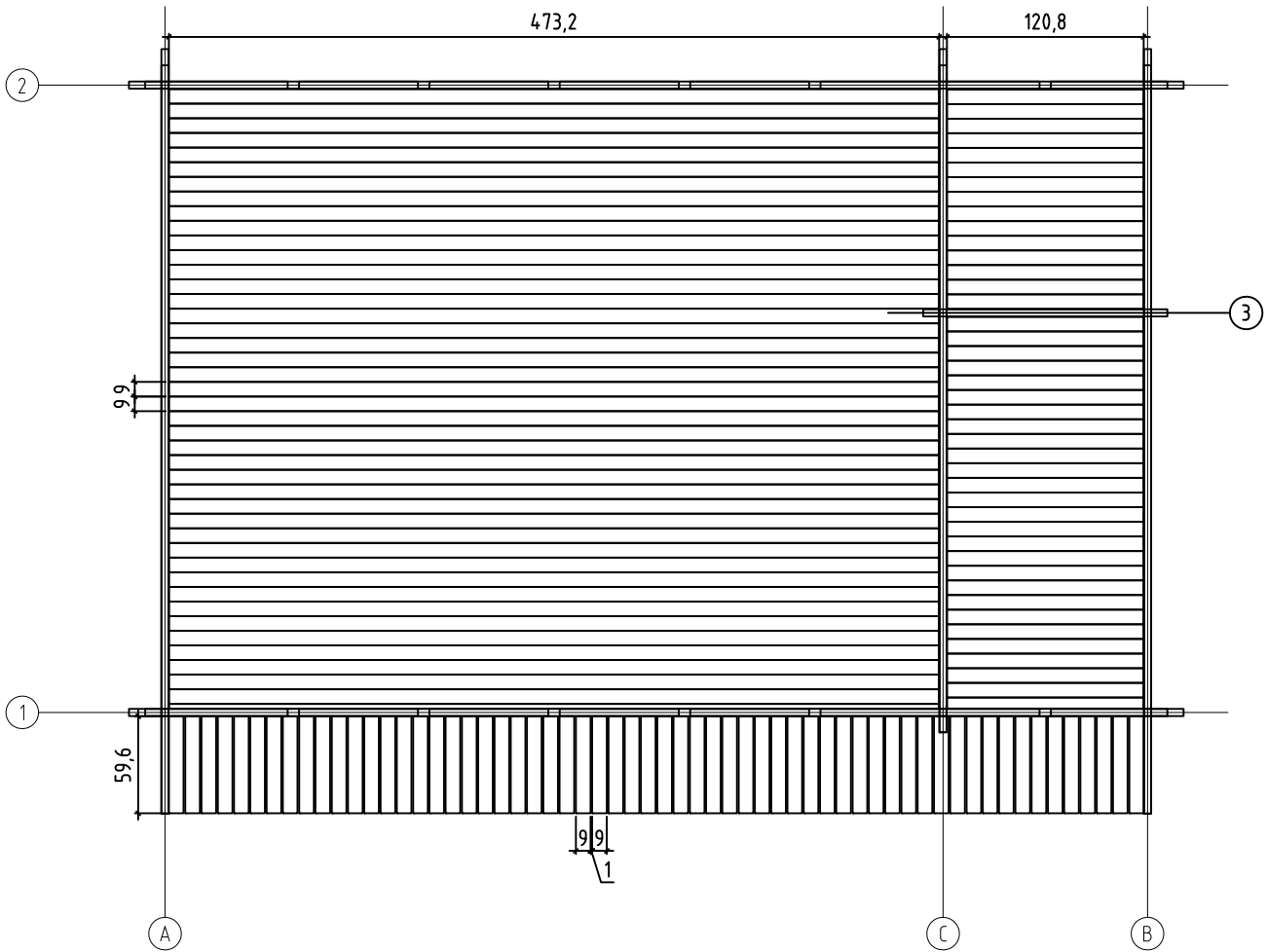

ROOF PLAN - DACH-PLAN - PLAN DU TOIT

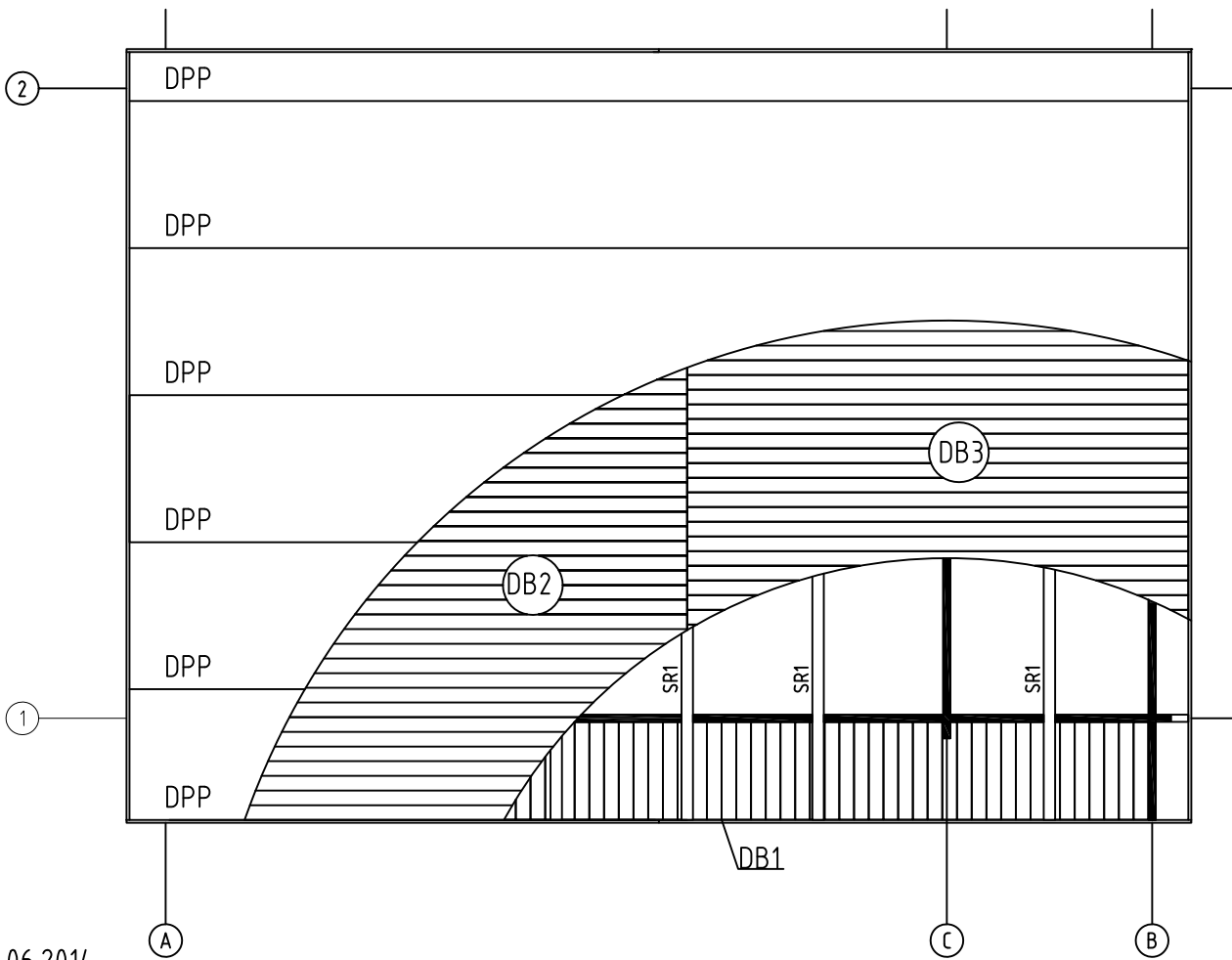

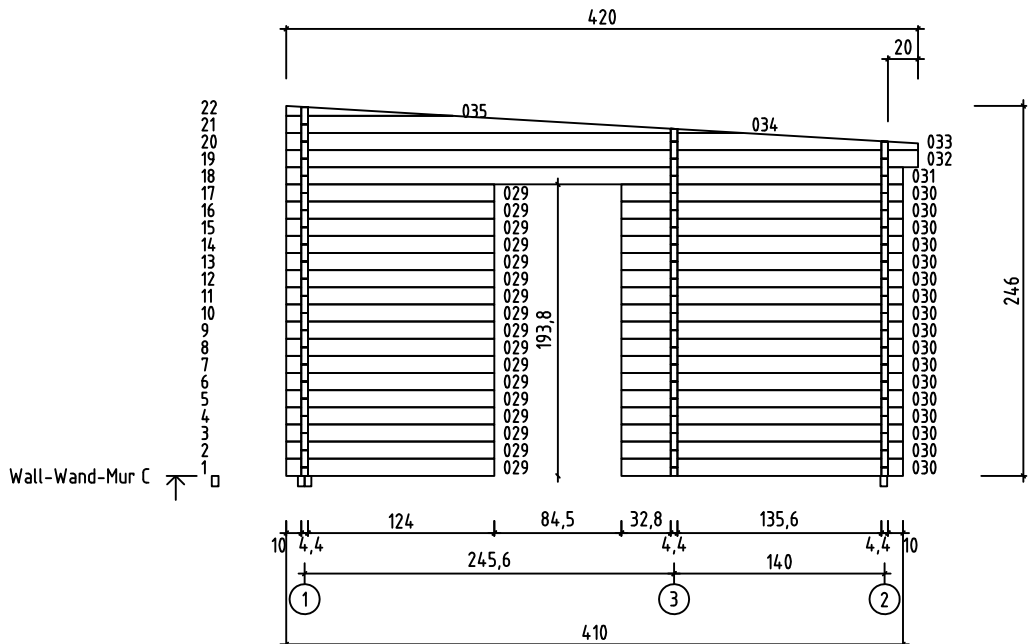
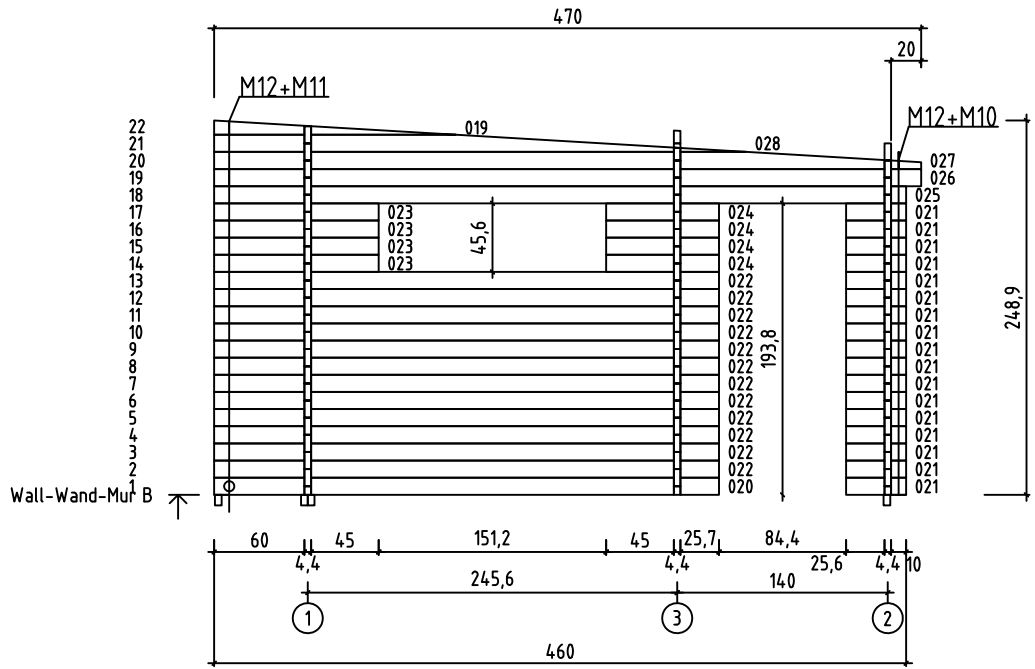
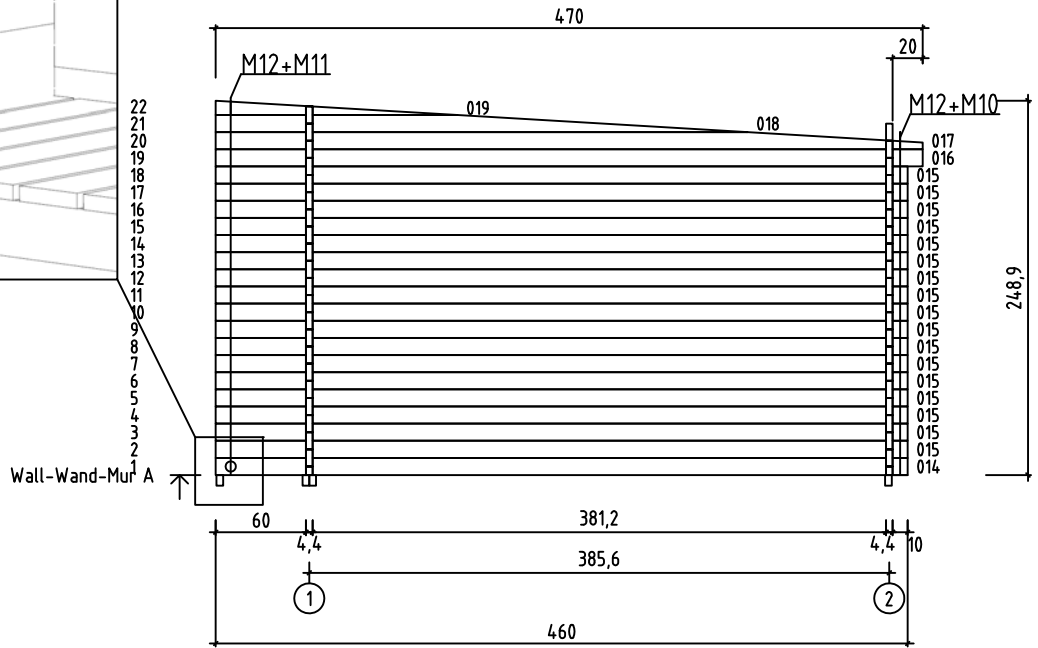
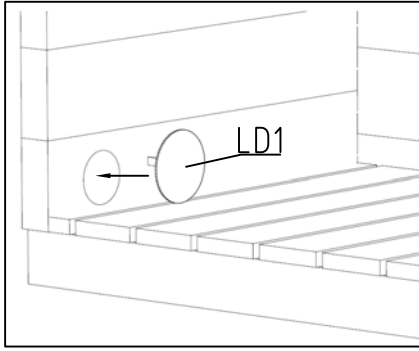

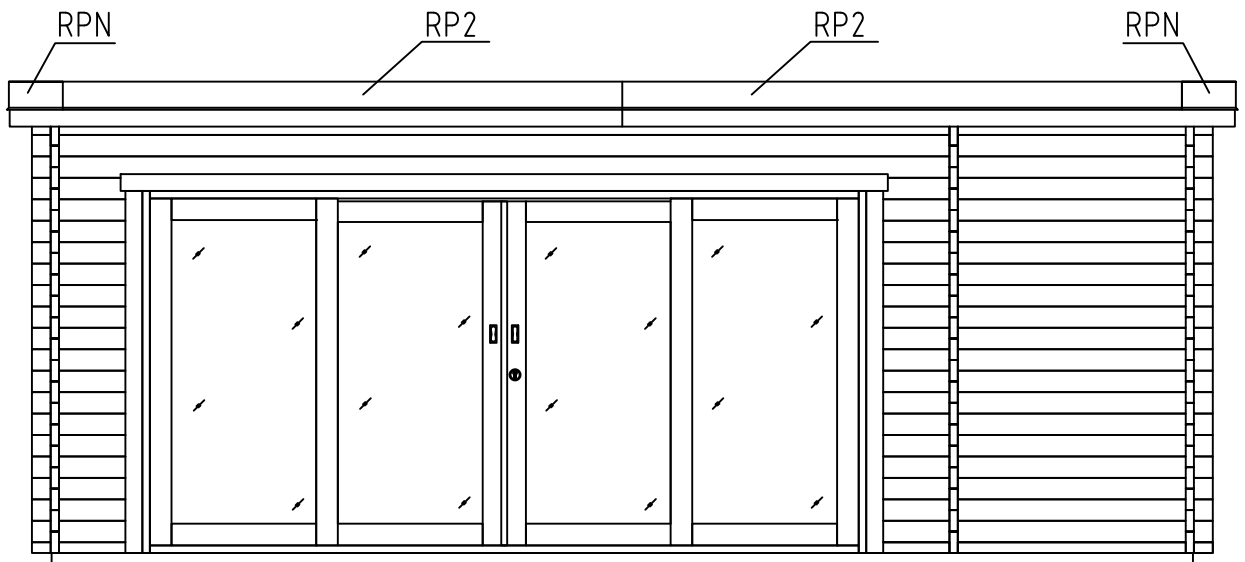



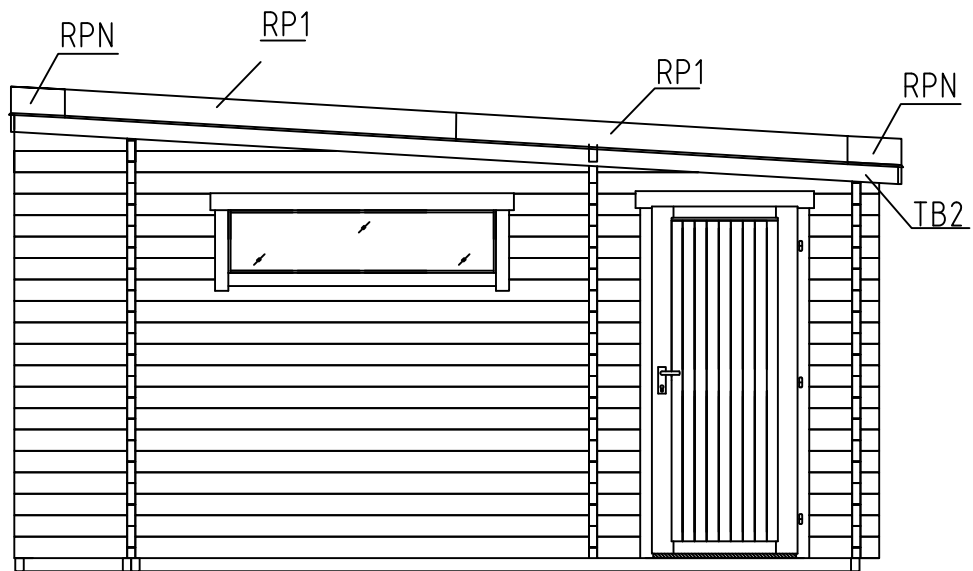





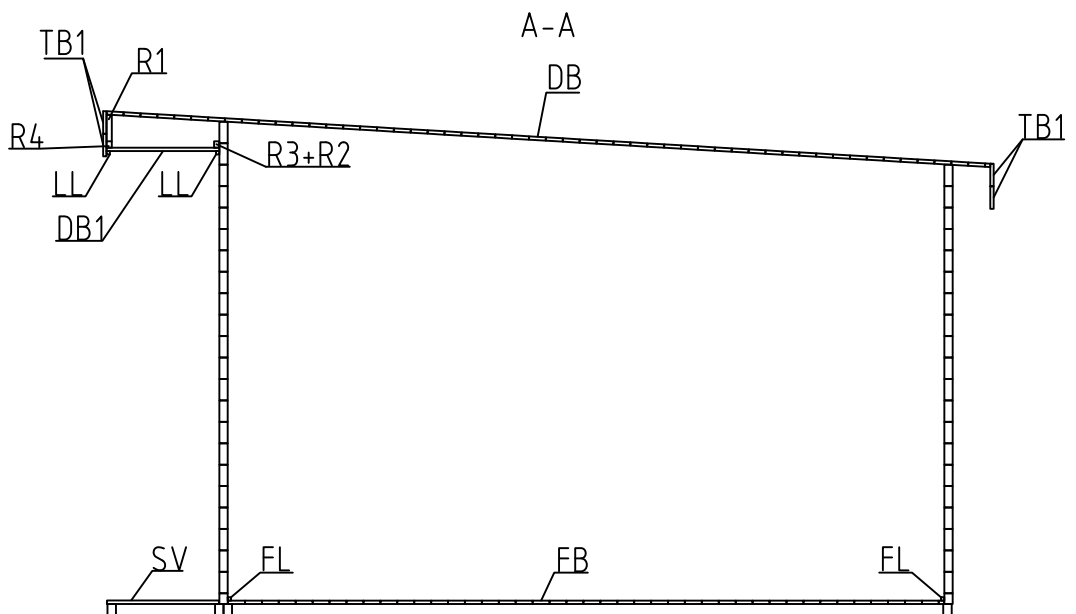



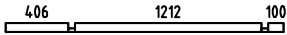

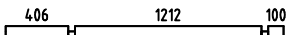

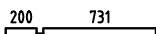

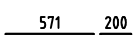
Wall-Wand-Mur 1 ↑







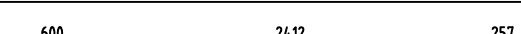

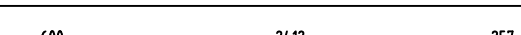
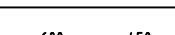
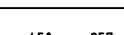
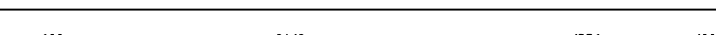
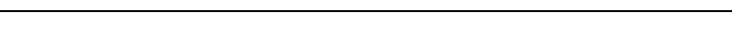
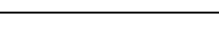
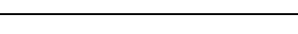



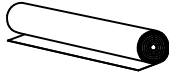
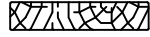
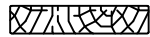



Wall-Wand-Mur B ↑



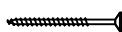

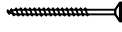
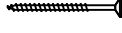
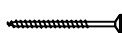

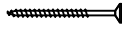
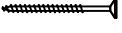
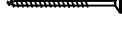
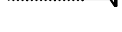

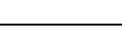
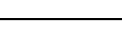
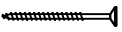

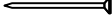

CROSS SECTION - SCHNITT - VU DE COUPE

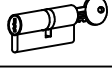

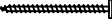
Pos	12.06.2014	Piece list - Stückliste - Liste des pièces Art.Nr. 4415811	7/12	Q.	P (mm)	L (mm)
001				1	44x57	550
002				1	44x57	1806
003				17	44x114	550
004				17	44x114	1806
005				21	44x114	6280
006				2	44x114	975
007				8	44x114	731
008				2	44x114	1346
009				2	44x114	815
010				1	44x57	6280
011				1	44x57	1500
012				19	44x114	1500
013				1	44x85	1500
014				1	44x114	4600
015				17	44x114	4600
016				1	44x114	4700
020				1	44x114	3357
021				17	44x114	400
022				12	44x114	3357
023				4	44x114	1094
024				4	44x114	751
025				1	44x114	4600
026				1	44x114	4700
029				17	44x114	1384
030				17	44x114	1872

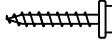
Pos	12.06.2014	Piece list - Stückliste - Liste des pièces Art.Nr. 4415711	8/12	Q.	P (mm)	L (mm)
031				1	44x114	4100
032				1	44x114	4200
WA-1				1		
WB-1				1		
WC-1				1		
IAR3	FOUNDATION - FUNDAMENT - FONDATION			4	45x70	4797
IAR2	FOUNDATION - FUNDAMENT - FONDATION			14	45x70	3783
IAR4	FOUNDATION - FUNDAMENT - FONDATION			4	45x70	1273
IAR1	FOUNDATION - FUNDAMENT - FONDATION			3	45x70	527
SR1	RAFTER - DACHSPARREN - CHEVRON			6	70x140	4717
FB	FLOOR BOARDS - FUSSBODENBRETTER - LAME DE PLANCHER			43	90x18	4732
FB	FLOOR BOARDS - FUSSBODENBRETTER - LAME DE PLANCHER			43	90x18	1208
DB2	ROOF BOARDS - DACHBRETTER - VOLIGES			53	90x18	3413
DB3	ROOF BOARDS - DACHBRETTER - VOLIGES			53	90x18	3067
DB1	ROOF BOARDS - DACHBRETTER - VOLIGES			67	90x18	596
SV	TERRACE BOARDS - TERRASSENBRETTER - PLANCHER DE TERRASSE			60	90x19	596
LL	CEILING FILLET - DECKELEISTE - PROFIL DE FINITION SOUS PLAFOND				18x18	13.17
FL	FLOOR FILLET-FUSSBODENLEISTE - CORNIERE DE FINITION DU PLANCHER				18x18	29.43
M10	TREADED ROD M10 - GEWINDESTANGE M10 - TIGE FILETÉE M10			2		250
M11	TREADED ROD M10 - GEWINDESTANGE M10 - TIGE FILETÉE M10			2		450
M12	TREADED ROD M10 - GEWINDESTANGE M10 - TIGE FILETÉE M10			4		2000
R1	LATH - PFETTEN - LITEAU			2	28x34	140
R2	LATH - PFETTEN - LITEAU			2	28x34	570
R3	LATH - PFETTEN - LITEAU			6	28x34	730
R4	LATH - PFETTEN - LITEAU			2	28x34	2996

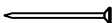
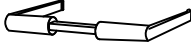
Pos	12.06.2014	Piece list - Stückliste - Liste des pièces Art.Nr. 4415811	9/12	Q.	P (mm)	L (mm)
DPP	ROOFING FELT - DACHPAPPE - FEUTRE BITUMEUX			6		6580
TB1	EAVES BOARD - TRAUFBRETT - BANDEAU DE TOIT			8	18x120	3258
TB2	EAVES BOARD - TRAUFBRETT - BANDEAU DE TOIT			4	18x120	4715
RP1	EAVES SHEET - ABSCHLUSSPROFIL - PROFIL DE FINITION MÉTALLIQUE POUR DÉBORD DE TOITURE			4		2200
RP2	EAVES SHEET - ABSCHLUSSPROFIL - PROFIL DE FINITION MÉTALLIQUE POUR DÉBORD DE TOITURE			4		3100
LD1	LID FOR TREADED ROD HOLE - ABDECKUNG FÜR GEWINDESTANGENÖFFNUNG - COUVERCLE POUR ACCÈS RÉGLAGÉ TIGE FILETÉE			2		
	LENGTHENING BOLT FOR TREADED ROD - VERLÄNGERUNGSMUTTER FÜR GEWINDESTANGE - MANCHON DE RACCORDEMENT DE TIGE FILETÉE			4		
	DRIVE NUT TREADED ROD - EINSHLAGMUTTER FÜR GEWINDESTANGE - ÉCROU A FRAPPER POUR TIGE FILETÉE			4		
	NUT FOR TREADED ROD - MUTTER FÜR GEWINDESTANGE - ÉCROU POUR TIGE FILETÉE			4		
	PLAIN WASHER TREADED ROD - UNTERLEGSSCHEIBE FÜR GEWINDESTANGE - RONDELLE PLATE POUR TIGE FILETÉE			4		
	SCREW FOR LOCK COVERS - SCHRAUBE FÜR SCHLOSSBLENDEN VIS POUR SET DE GARNITURES DE SERRURE DE PORTE			4	3.5x15	
	SCREW FOR DOOR HANDLE FITTINGS - SCHRAUBE FÜR TÜRGRIF - VIS POUR SET DE GARNITURES DE SERRURE DE PORTE			16	3x30	
	SCREW FOR SLIDING DOOR ROLLER- SCHRAUBE FÜR SCHIEBETÜR LAUFRAD - VIS POUR FERRURE DE PORTE COULISSANTE			8	3x30	
	SCREW FOR DOOR FILLET - SCHRAUBE ZUR BEFESTIGUNG TÜRLEISTE - VIS D'ASSEMBLAGE DU CADRE DE PORTE			5	3x30	
	SCREW FOR ROOF LATH - SCHRAUBE FÜR DACHLATTE - VIS POUR LATTE			33	4x40	
	SCREW FOR EAVES BOARDS - SCHRAUBEN FÜR TRAUFBRETT - VIS DE FIXATION POUR BANDEAU DE TOIT			106	4x40	
HS4	SCREW FOR DOOR COVERING MOULDING - SCHRAUBEN FÜR DECKUNGSPROFIL - VIS DE FIXATION PROFILS DE FINITION VERTICAUX A FIXER A L'EXTERIEUR DU CADRE DE LA PORTE			20	4x40	
	SCREW FOR ROOF BEAMS - SCHRAUBEN FÜR DACHBALKEN - VIS POUR PANNE DE TOIT			18	5x120	
HS1	SCREW FOR DOOR JAMB - SCHRAUBE FÜR TÜRRAHMEN - VIS DE FIXATION POUR MONTANT DE PORTE			4	5x120	
	SCREW FOR GABLE - SCHRAUBEN FÜR GIEBEL - VIS POUR FIXATION DES PIGNONS			18	5x120	
	SCREW FOR 1. WALL BEAM - SCHRAUBE FÜR 1. BOHLENREIHE - VIS DE FIXATION DES FONDATIONS			12	5x90	
	SCREW FOR FUNDAMENT - SCHRAUBEN ZUR BEFESTIGUNG FUNDAMENT - VIS POUR FONDATION			54	5x90	
HS2	SCREW FOR DOOR JAMB - SCHRAUBE FÜR TÜRRAHMEN - VIS DE FIXATION POUR MONTANT DE PORTE			4	5x90	
HS3	SCREW FOR FIXING DOOR - SCHRAUBE FÜR BEFESTIGUNG TÜR- VIS POUR FIXATION DE PORTE			16	5x90	
	SCREW FOR DET 006,007,008,009 - SCHRAUBE FÜR DET 006,007,008,009 - VIS POUR DET 006,007,008,009			28	6x180	

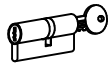
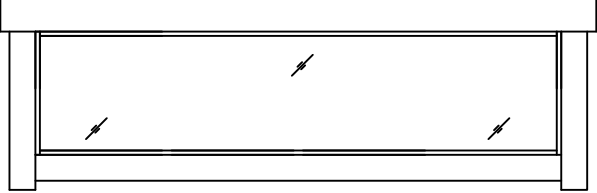
Pos	12.06.2014	Piece list - Stückliste - Liste des pièces Art.Nr. 4415811	10/12	Q.	P (mm)	L (mm)
		ZN NAIL FOR TERRACE - ZN NÄGEL FÜR TERRASSENBRETT - POINTE POUR PLANCHER DE TERRASSE		244	2.1x50	
		ZN NAIL FOR CEILING FILLET - ZN NÄGEL DECKELEISTE - POINTE POUR PROFIL DE FINITION SOUS PLAFOND		27	1.4x40	
		ZN NAIL FOR FLOOR FILLET - ZN NÄGEL FÜR FUSSBODENLEISTE - POINTE POUR CORNIERE DE FINITION DU PLANCHER		60	1.4x40	
		HAMMER BLOCK - SCHLAGHOLZ - CALLE DE FRAPPE		1		
		DOOR HANDLE FITTINGS - TÜRGRIFF - SET DE GARNITURES DE SERRURE DE PORTE		4		
		CYLINDER - ZYLINDERSCHLOSS - CYLINDRE DE SERRURE		1		
		ROLLER FOR SLIDING DOOR - LAUFRAD FÜR SCHIEBETÜR - FERRURE POUR PORTE COULISSANTE		4		
		SET OF DOOR LOCK COVERS - SCHLOSSBLENDEN - SET DE GARNITURES DE SERRURE DE PORTE		2		
		SCREW FOR DOORSTEP - SCHRAUBEN FÜR TÜRSCHWELLE - VIS DE FIXATION DU SEUIL DE PORTE		4	4.5x65	
		ROOFING NAILS FOR ROOFING FELT - NÄGEL FÜR DACHPAPPE - POINTE DE FIXATION POUR FEUTRE BITUMEUX		315	2.8x15	
		SCREW FOR EAVES SHEET - SCHRAUBE FÜR ABSCHLUSSPROFIL - VIS POUR PROFIL DE FINITION MÉTALLIQUE POUR DÉBORD DE TOITURE		56	4.8x28	
RPN		EAVES SHEET CORNER - ECKPROFIL- PROFIL D'HABILLAGE DE RIVES		4		
		ZN NAIL FOR ROOF - ZN NÄGEL FÜR DACHBRETT - POINTE POUR TOIT		888	2x50	
		ZN NAIL FOR FLOOR - ZN NÄGEL FÜR FUSSBODENBRETT - CLOUS POUR PLANCHER		528	2x50	
		DOOR HANDLE FITTINGS-TÜRGRIFF - SET DE GARNITURES DE SERRURE DE PORTE		2		
		SET OF DOOR LOCK COVERS - SCHLOSSBLENDEN - SET DE GARNITURES DE SERRURE DE PORTE		2		
		CYLINDER - ZYLINDERSCHLOSS - CYLINDRE DE SERRURE		2		
		WINDOW - FENSTER - FENETRE 1500x410 AK.1.100.PMO.k	DGP	1		
						

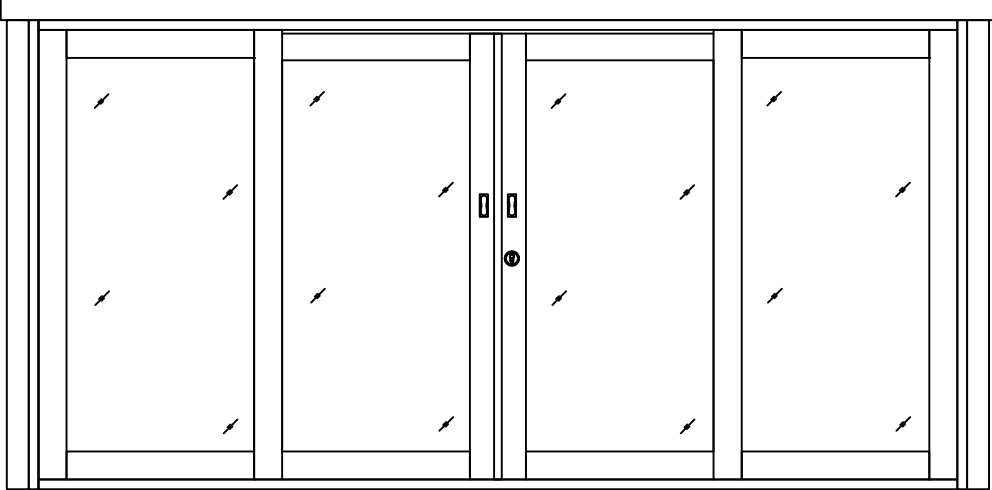
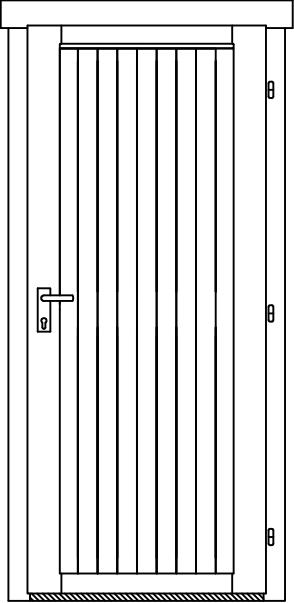
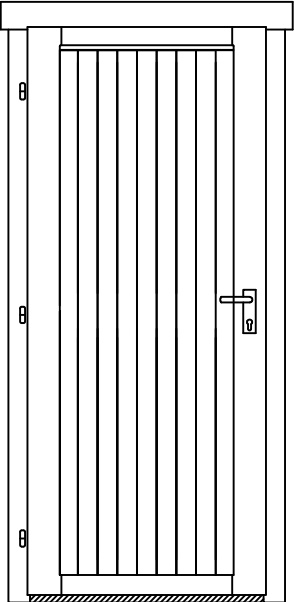
Pos	12.06.2014 Piece list - Stückliste - Liste des pièces Art.Nr. 4415811	11/12	Q.	P (mm)	L (mm)
	DOOR - TÜR - PORTE 3914x1957 TUK.1100.PLP.MMf DGP 	1			
	DOOR - TÜR - PORTE 835x1900 UL.2.100.IVP.MMWd DGP 	1			
	DOOR - TÜR - PORTE 835x1900 UL.2.100.IVV.MMWd DGP 	1			

1

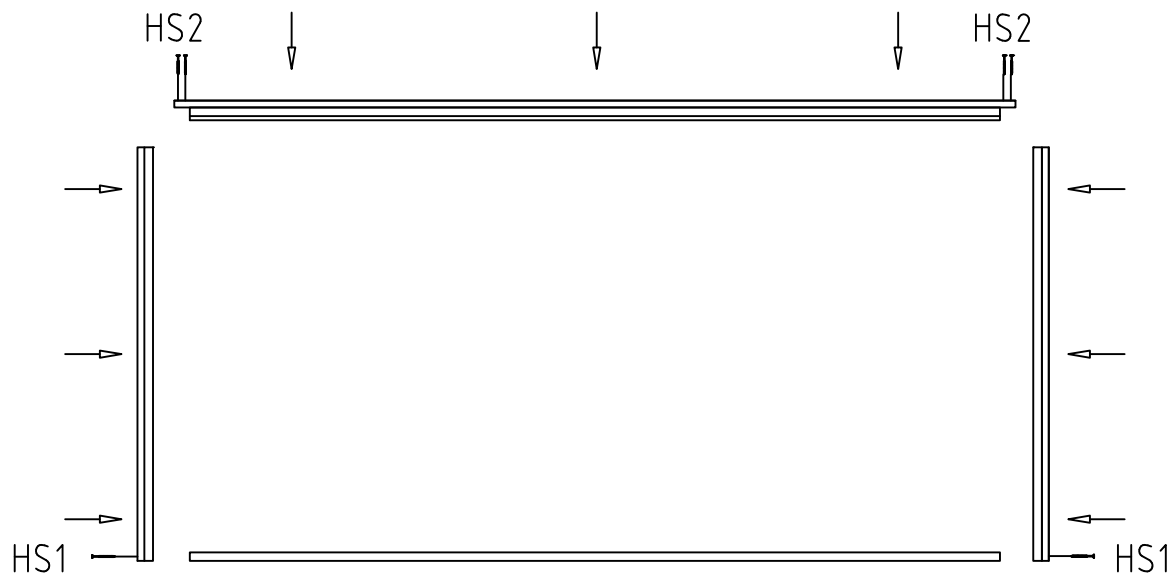

2

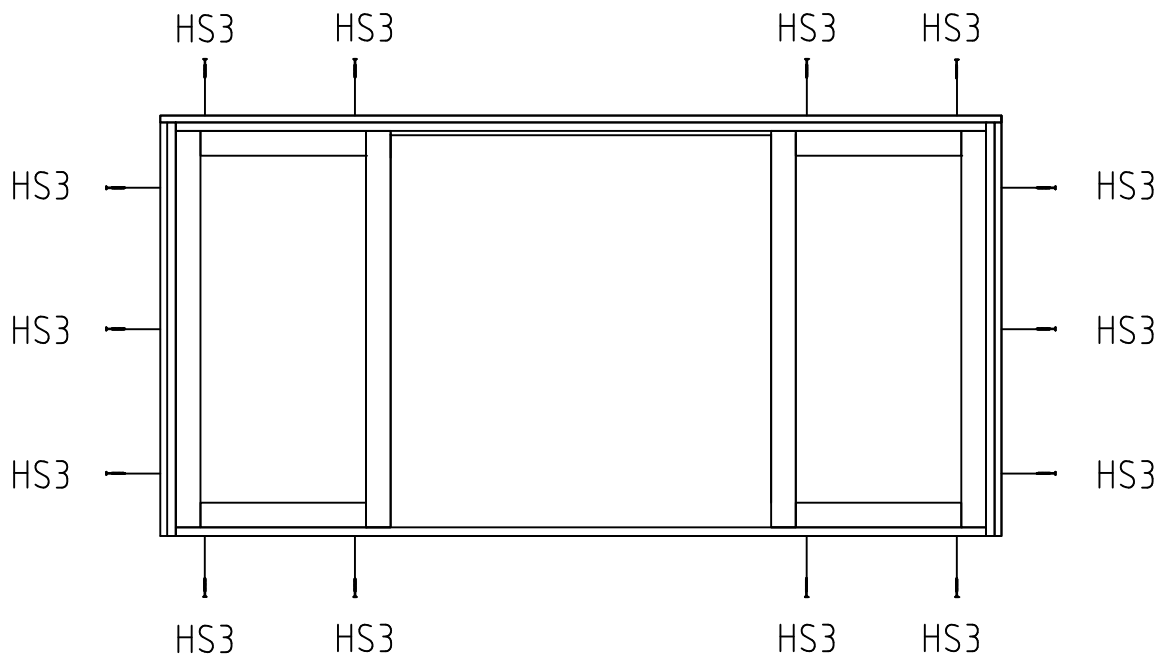

3

