

*Montrose 44*  
*Art. Nr. 4419902*  
1/12

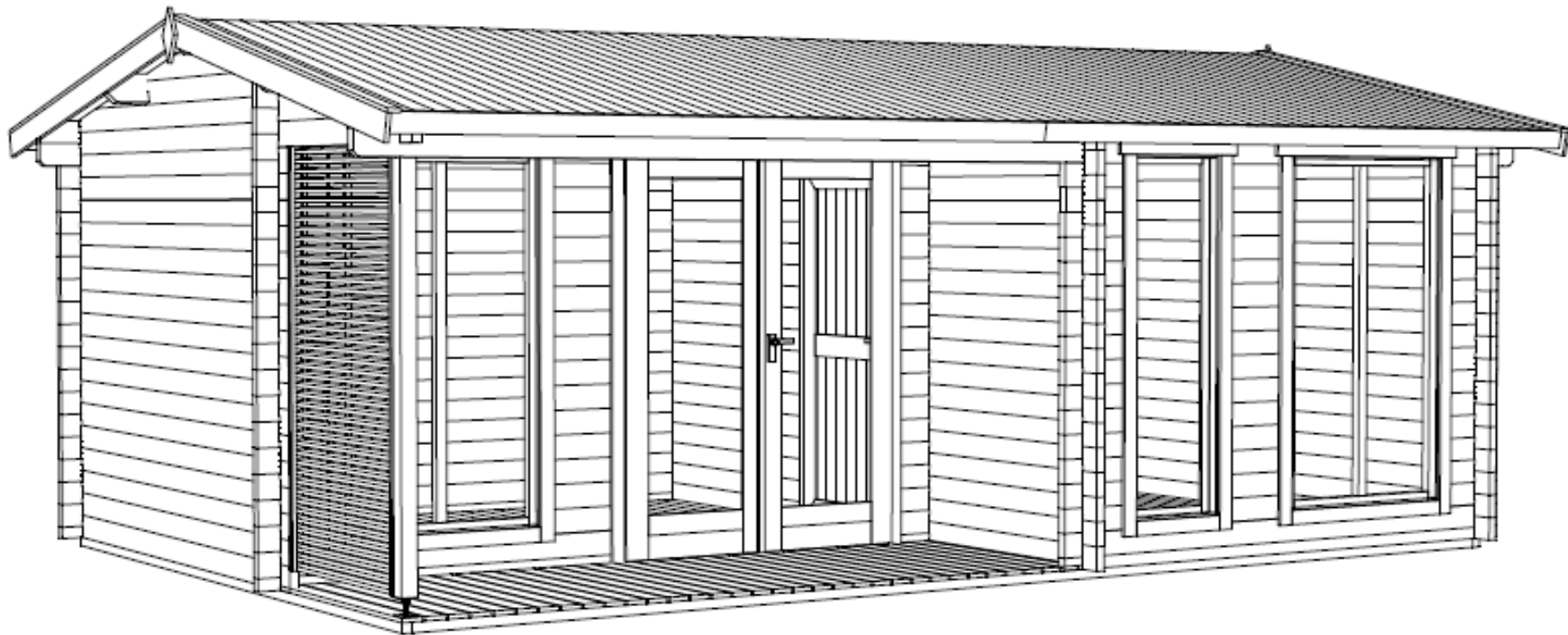

GROUNDPLAN - GRUNDPLAN - PLAN DE MASSE

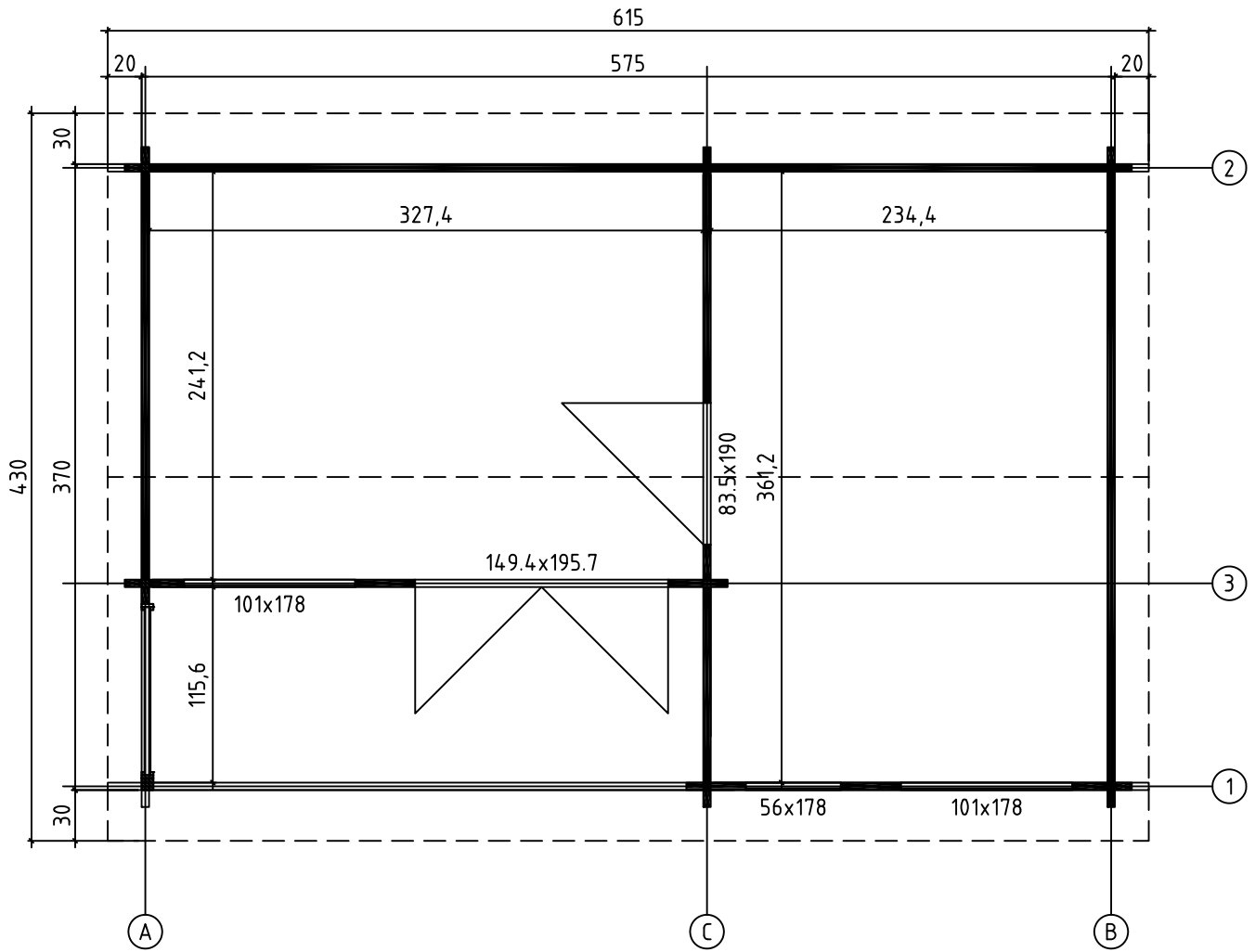

FOUNDATION - FUNDAMENT - FONDATION

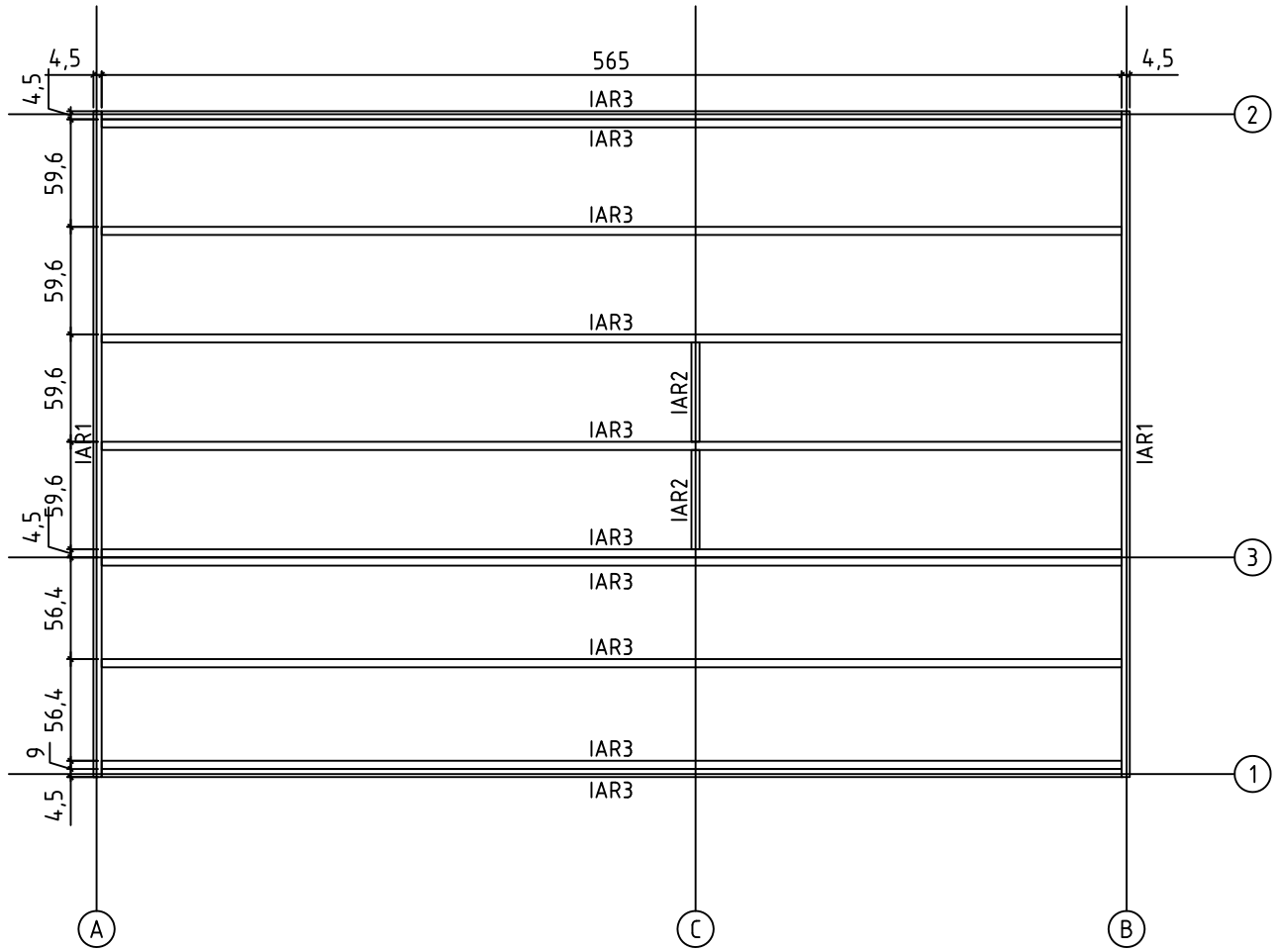

FLOOR BOARDS - FUSSBODENBRETTER - PLAN POSE PLANCHER  
TERRACE BOARDS - TERRASSENBRETTER - PLANCHER DE TERRASSE

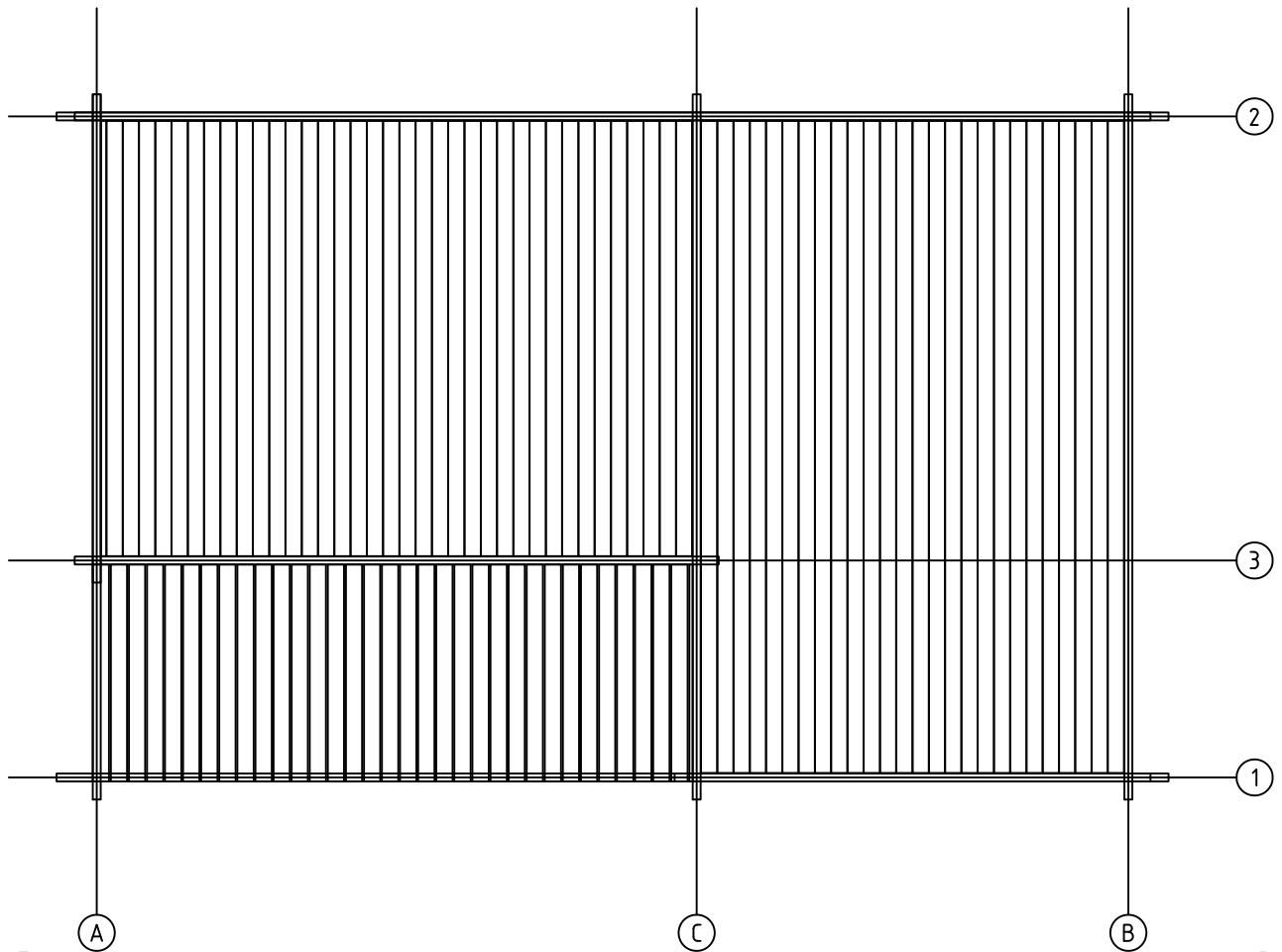

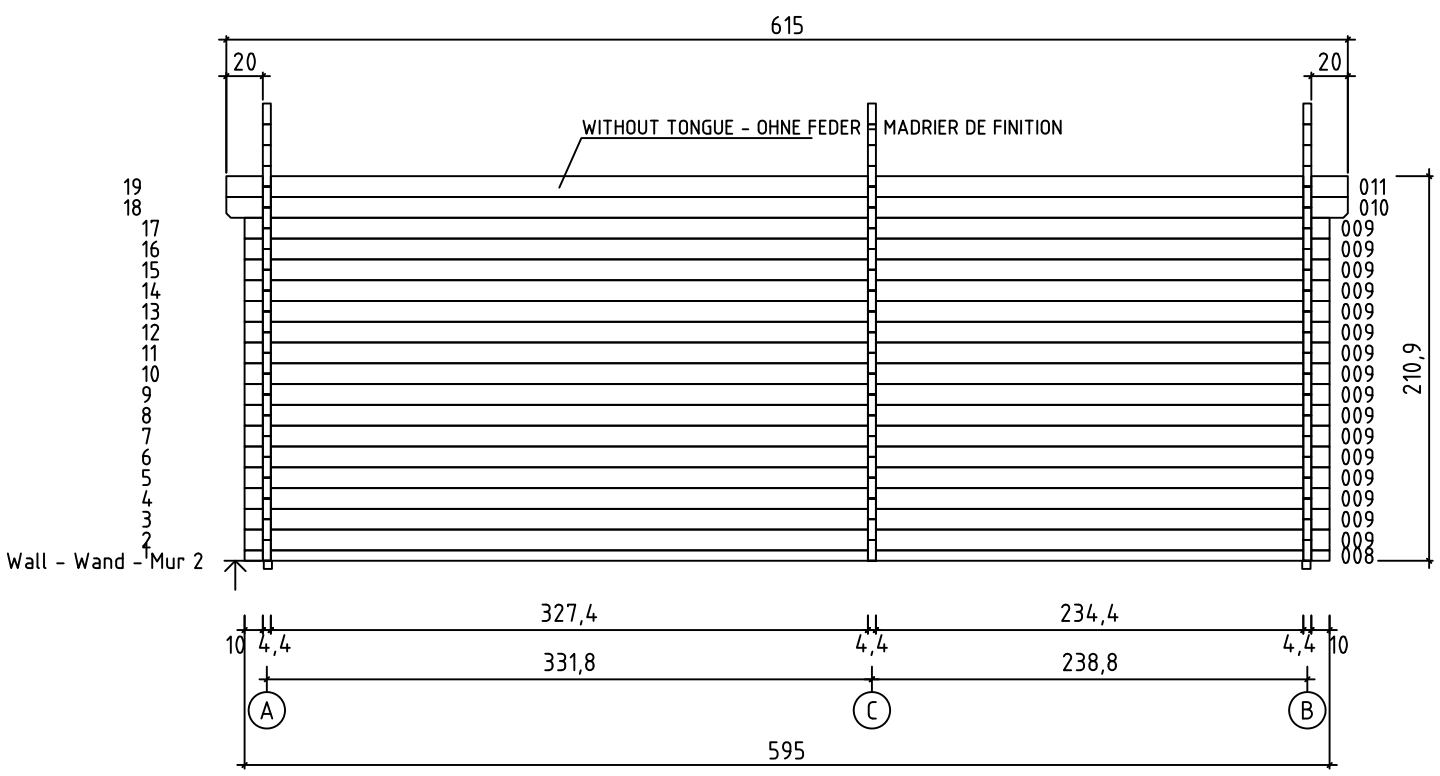
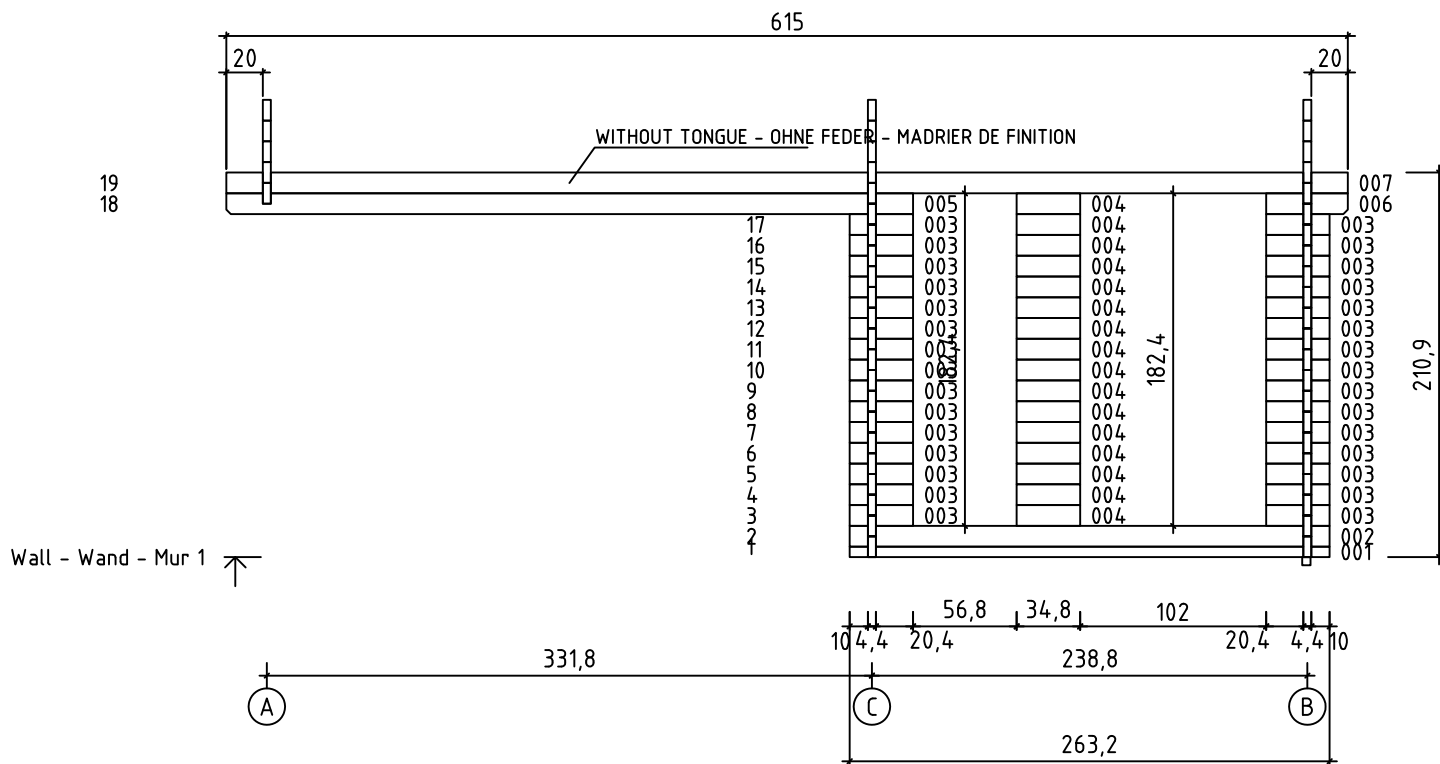

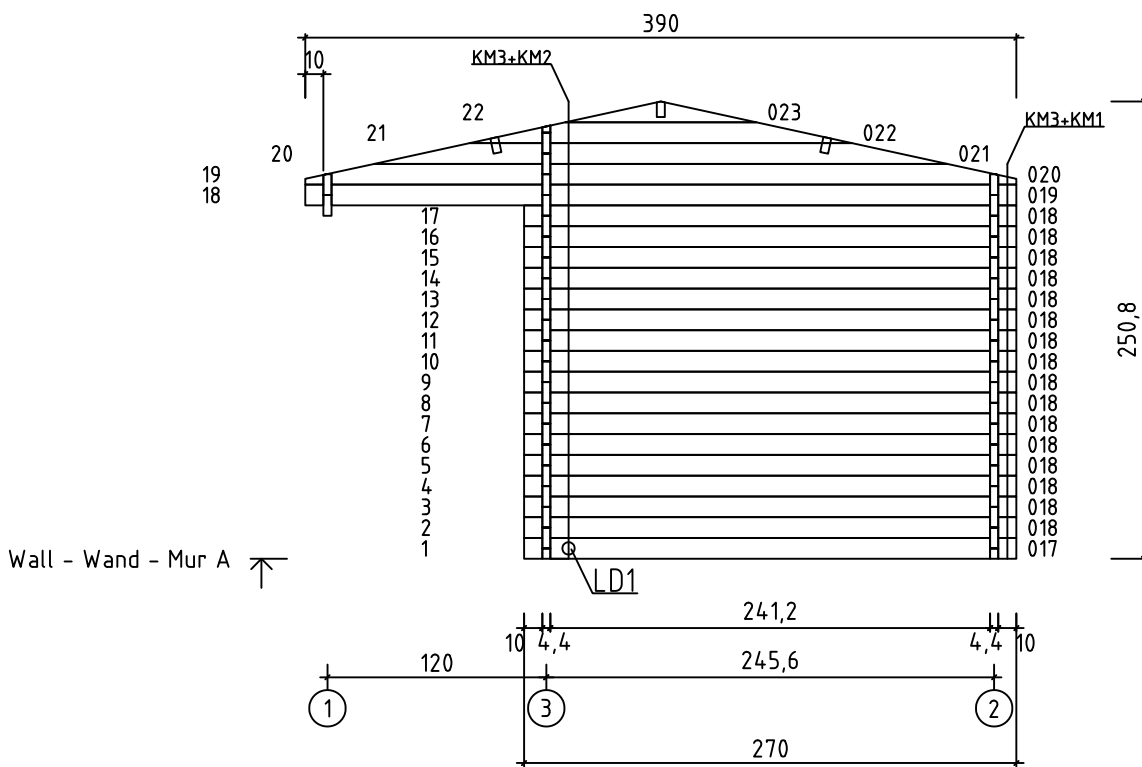
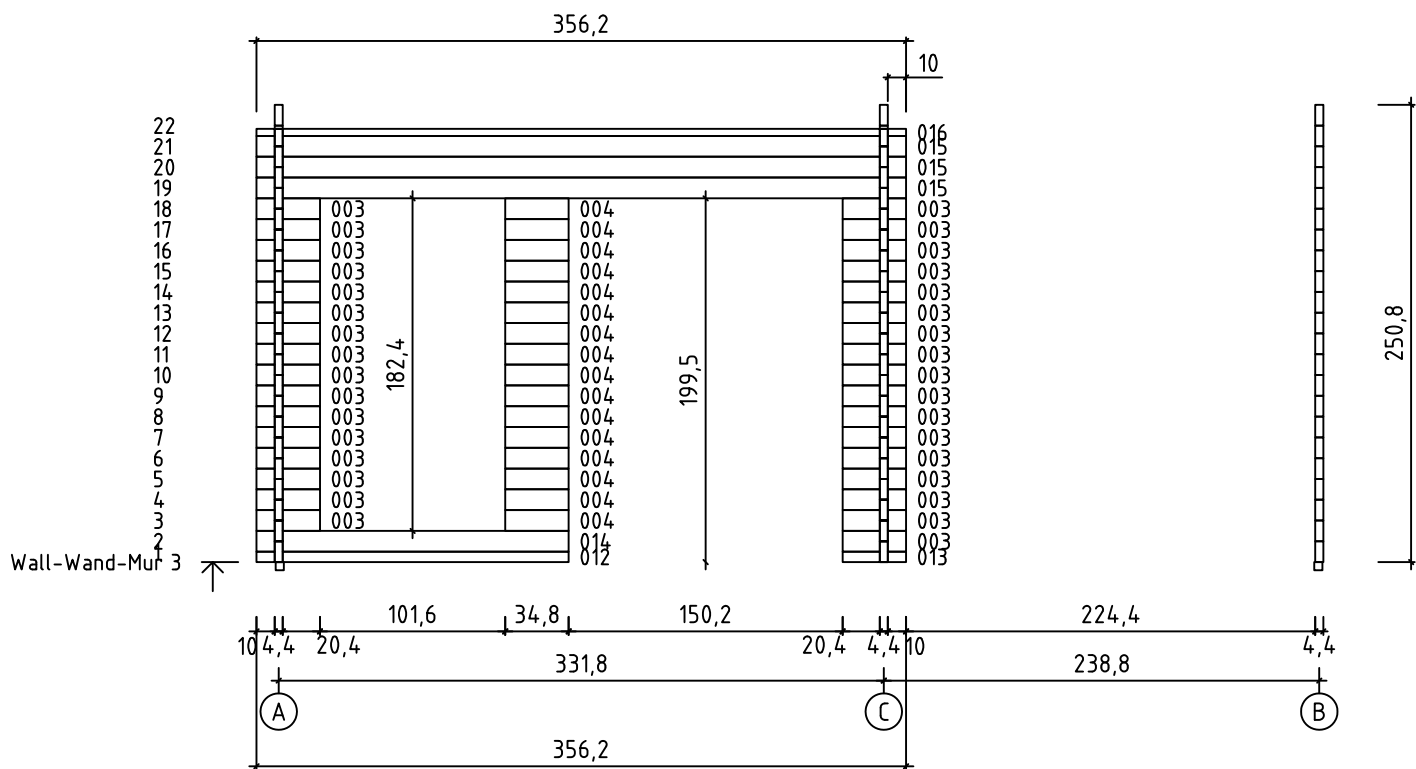

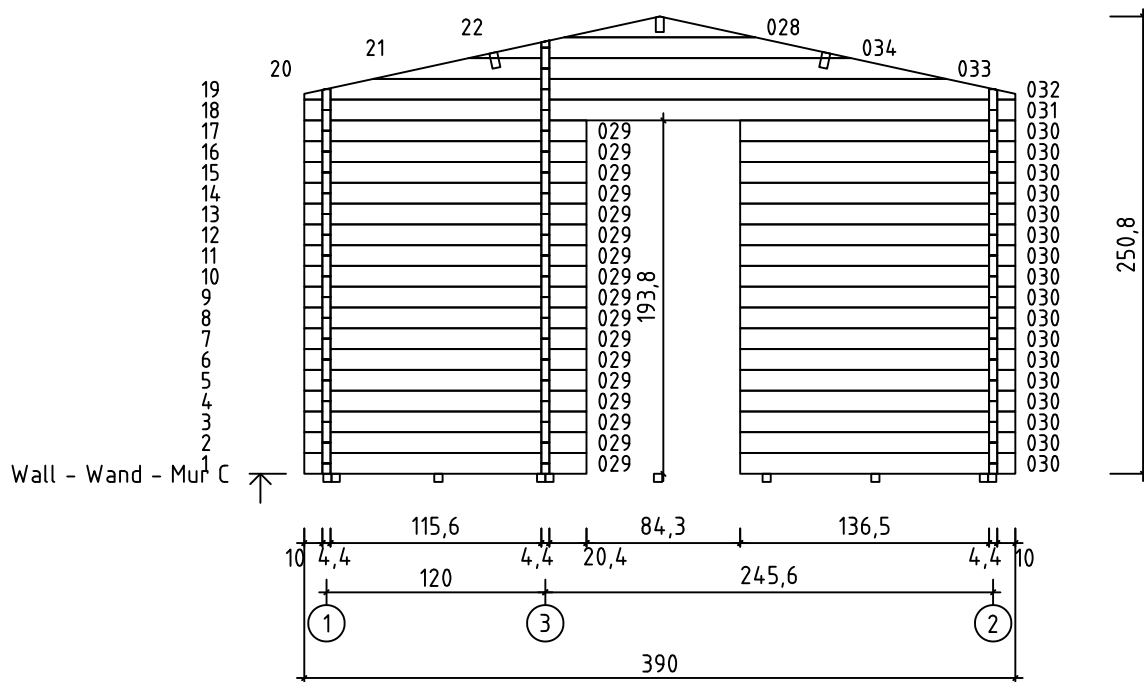
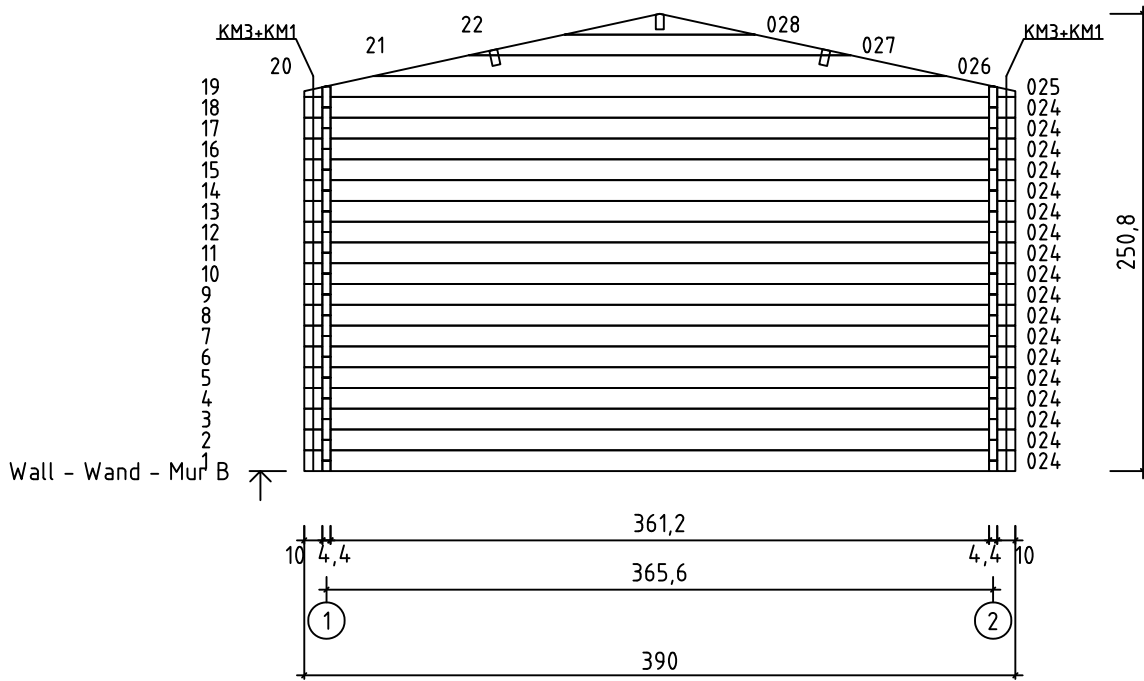

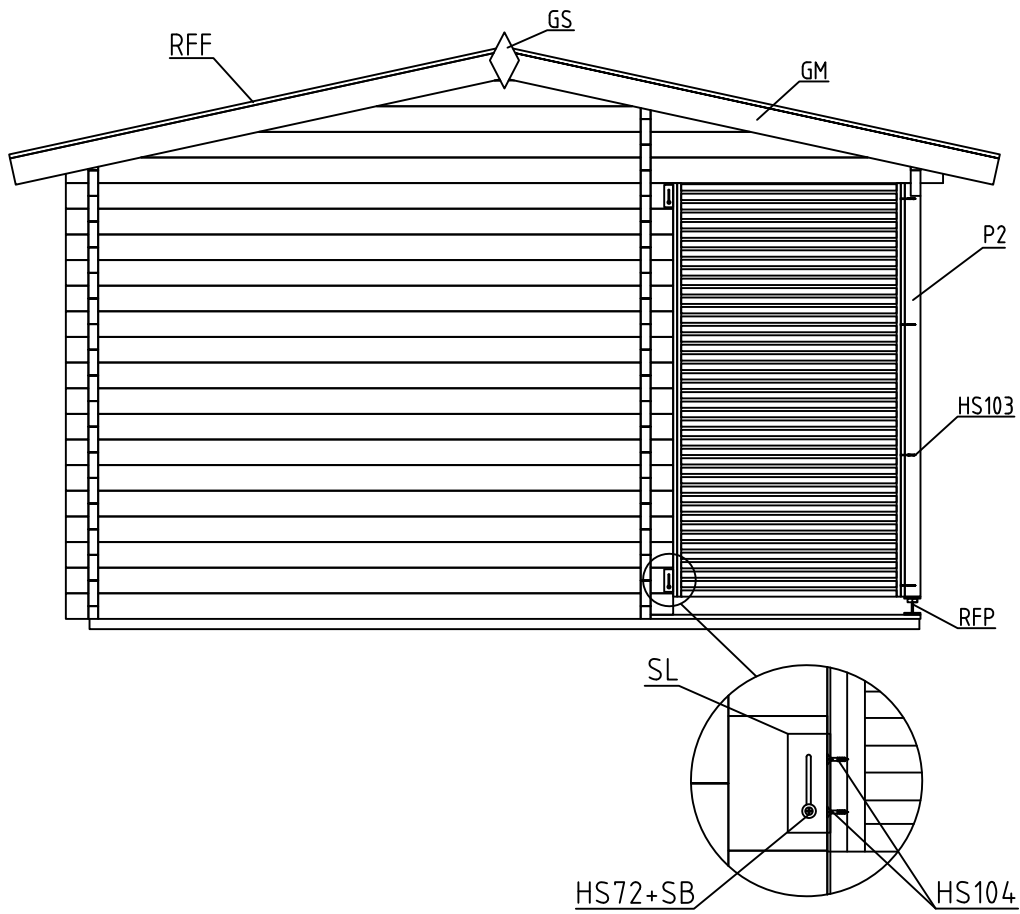



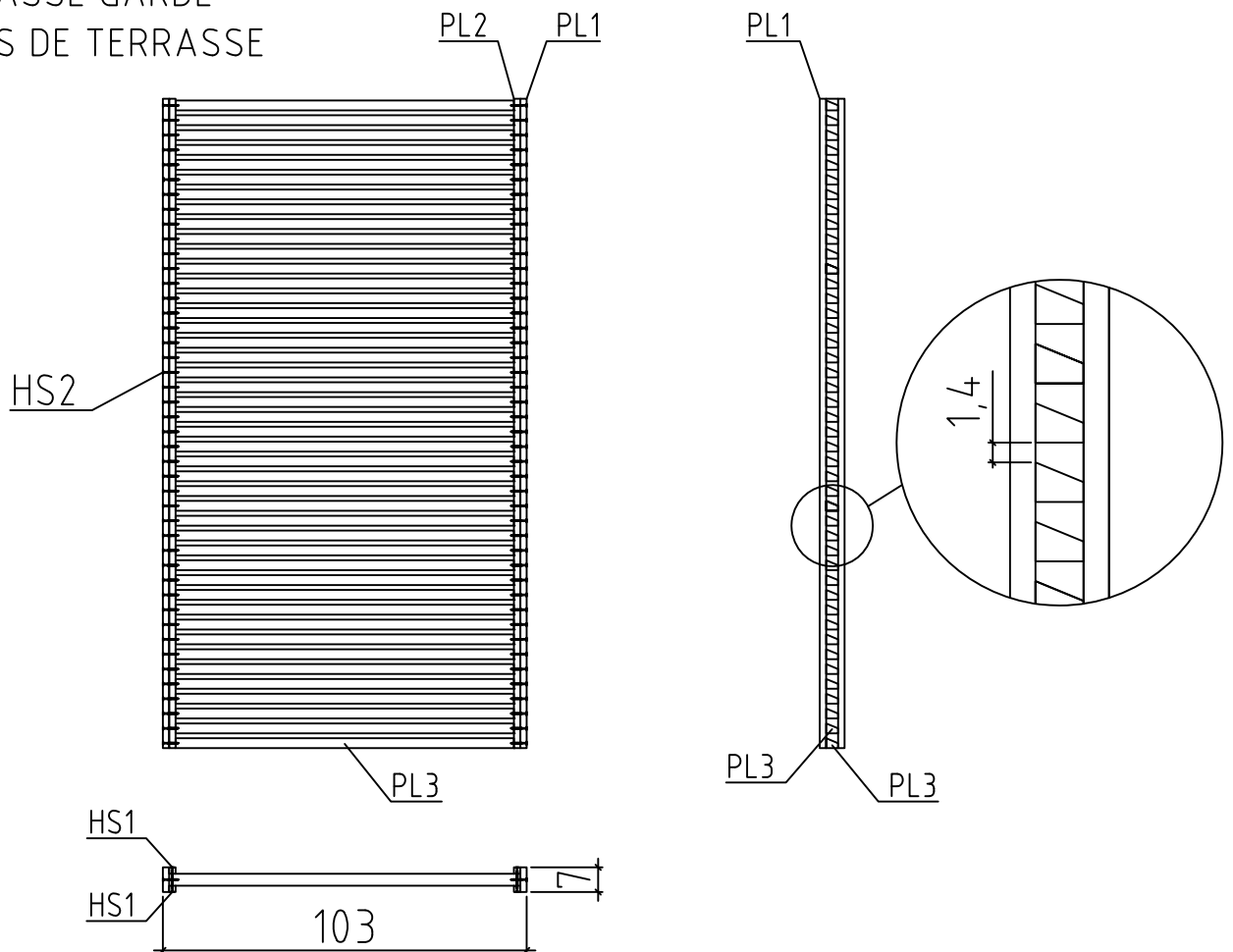

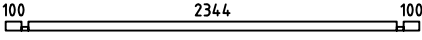
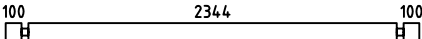

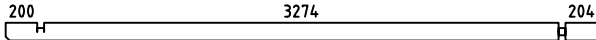

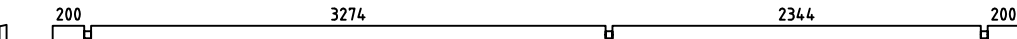
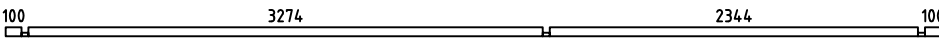
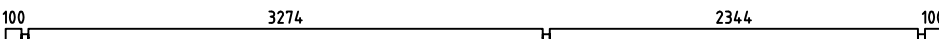

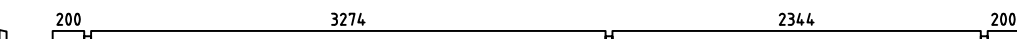
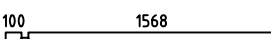

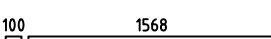
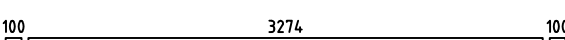
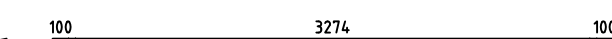
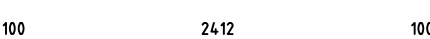
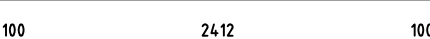

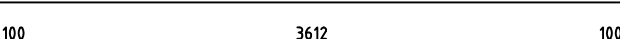
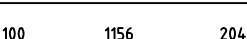
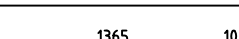
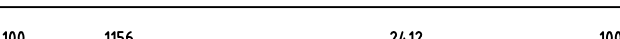
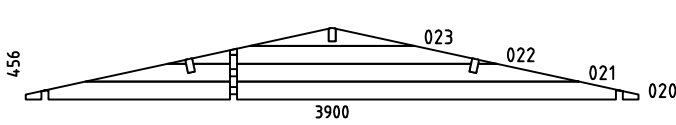



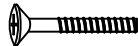

TERRACE RAILING -  
TERRASSE GARDE -  
CORPS DE TERRASSE

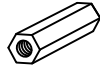
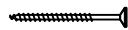
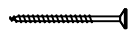
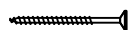









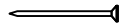

Pos	11.11.2015	Piece list - Stückliste - Liste des pièces Art.Nr. 4419902	8/12	Q.	P (mm)	L (mm)
001				1	44x57	2632
002				1	44x114	2632
003				63	44x114	348
004				32	44x114	348
005				1	44x114	3766
006				1	44x114	448
007				1	44x120	6150
008				1	44x57	5950
009				16	44x114	5950
010				1	44x114	6150
011				1	44x120	6150
012				1	44x57	1712
013				1	44x57	348
014				1	44x114	1712
015				3	44x114	3562
016				1	44x39	3562
017				1	44x114	2700
018				16	44x114	2700
019				1	44x114	3900
024				18	44x114	3900
029				17	44x114	1548
030				17	44x114	1509
031				1	44x114	3900
WA-1				1		

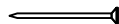

Pos	11.11.2015	Piece list - Stückliste - Liste des pièces Art.Nr. 4419902	9/12	Q.	P (mm)	L (mm)
WB-1				1		
WC-1				1		
IAR3		FOUNDATION - FUNDAMENT - FONDATION 		10	45x45	5650
IAR1		FOUNDATION - FUNDAMENT - FONDATION 		2	45x45	3690
IAR2		FOUNDATION - FUNDAMENT - FONDATION 		2	45x45	551
PR1		ROOF BEAM - DACHBALKEN - PANNE DE TOIT 200 3274 2344 200 		1	44x140	6150
A-PR1		ROOF BEAM - DACHBALKEN - PANNE DE TOIT 200 3274 2344 200 		2	44x140	6150
		FLOOR BOARDS - FUSSBODENBRETTER - LAME DE PLANCHER 		26	90x18	3608
		FLOOR BOARDS - FUSSBODENBRETTER - LAME DE PLANCHER 		37	90x18	2408
		TERRACE BOARDS - TERRASSENBRETTER - PLANCHER DE TERRASSE 		34	90x19	1200
		ROOF BOARDS - DACHBRETTER - VOLIGES 		138	90x18	2200
		FLOOR FILLET - FUSSBODENLEISTE - CORNIERE DE FINITION DU PLANCHER 			18x18	23.25
RFF		ROOFING FELT FILLET - DACHPAPPENLEISTE - BAGUETTE DE FIXATION DU FEUTRE BITUMEUX 		4	18x58	2250
KM1		TREADED ROD M10 - GEWINDESTANGE M10 - TIGE FILETÉE M10 		3		125
KM2		TREADED ROD M10 - GEWINDESTANGE M10 - TIGE FILETÉE M10 		1		340
KM3		TREADED ROD M10 - GEWINDESTANGE M10 - TIGE FILETÉE M10 		4		2000
PL1		FILLE FOR TERRACE RAILING - LEISTE FÜR TERRASSE - BAGUETTE POUR CORPS DE TERRASSE 		4	18x18	1839
PL2		FILLE FOR TERRACE RAILING - LEISTE FÜR TERRASSE - BAGUETTE POUR CORPS DE TERRASSE 		44	28x34	994
PL3		FILLE FOR TERRACE RAILING - LEISTE FÜR TERRASSE - BAGUETTE POUR CORPS DE TERRASSE 		2	18x70	1839
P2		POST - PFOSTEN - POTEAU 		1	70x70	1838
GL		FASCIA BOARD - TRAUFBRETT - BANDEAU DE TOIT 		4	18x90	3075
		ROOF EDGE REINFORCEMENT - DACHRANDVERSTÄRKUNG - CORNIERE DE RENFORT DE BORD DE TOIT 		4	28x34	3075
		GABLE MOULDING - GIEBELLEISTE - PLANCHE DE RIVE 		4	18x120	2250

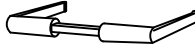
Pos	11.11.2015	Piece list - Stückliste - Liste des pièces Art.Nr. 4419902	10/12	Q.	P (mm)	L (mm)
		WINDOW HANDLE FITTINGS - FENSTERGRIFF - POIGNÉE D'OUVERTURE DE FENETRE		2		
		BOLT FOR WINDOW HANDLE FITTINGS - BOLZEN FÜR FENSTERGRIFF BESCHLAG - BOULON POUR POIGNÉE D'OUVERTURE DE FENETRE		4		
		LID FOR TREADED ROD HOLE - ABDECKUNG FÜR GEWINDESTANGENÖFFNUNG - COUVERCLE POUR ACCÈS RÉGLAGÉ TIGE FILETÉE		1		
		LENGTHENING BOLT FOR TREADED ROD - VERLÄNGERUNGSMUTTER FÜR GEWINDESTANGE - MANCHON DE RACCORDEMENT DE TIGE FILETÉE		4		
HS104		SCREW FOR SLIDING WALL TIE - SCHIEBEREGLER FÜR WAND - SABOT MÉTALLIQUE POUR FIXATION MUR		8	3.5x20	
		SCREW FOR GABLE SEGMENT - SCHRAUBEN FÜR DECKBLATT - VIS POUR FIXATION LOSANGE DE FINITION		4	3.5x35	
		SCREW FOR POST - SCHRAUBEN FÜR PFOSTEN - VIS DE FIXATION DES POTEAUX		2	3.5x50	
		SCREW FOR GABLE MOULDING - SCHRAUBEN FÜR GIEBELLEISTE - VIS DE FIXATION POUR PLANCHE DE RIVE		24	3.5x50	
HS1		SCREW FOR COVERING MOULDING - SCHRAUBEN FÜR DECKUNGSPROFIL - VIS DE FIXATION PROFILS DE FINITION VERTICAUX A FIXER A L'EXTERIEUR DU CADRE DE LA PORTE		20	3x30	
		SCREW FOR DOOR FILLET - SCHRAUBE ZUR BEFESTIGUNG TÜRLEISTE - VIS D'ASSEMBLAGE DU CADRE DE PORTE		5	3x30	
HS103		SCREW FOR FIXING TERRACE RAILING - SCHRAUBE FÜR TERRASSE VIS DE FIXATION DE GARDE-CORPS DE TERRASSE		4	4.5x80	
		SCREW FOR COVERING MOULDING - SCHRAUBEN FÜR DECKUNGSPROFIL - VIS DE FIXATION PROFILS DE FINITION VERTICAUX A FIXER A L'EXTERIEUR DU CADRE DE LA PORTE		88	4x40	
		SCREW FOR FASCIA BOARDS - SCHRAUBEN FÜR TRAUFBRETTEN - VIS DE FIXATION POUR BANDEAU DE TOIT		28	4x40	
		SCREW FOR ROOF EDGE REINFORCEMENT - SCHRAUBEN FÜR DACHRANDVERSTÄRKUNG - VIS POUR RENFORT DE BORD DE TOIT		28	4x40	
		SCREW FOR ROOF BEAMS - SCHRAUBEN FÜR DACHBALKEN - VIS POUR PANNE DE TOIT		15	5x120	
		SCREW FOR GABLE - SCHRAUBEN FÜR GIEBEL - VIS POUR FIXATION DES PIGNONS		16	5x120	
		SCREW FOR 1. WALL BEAM - SCHRAUBE FÜR 1. BOHLENREIHE - VIS DE FIXATIONS 1ERE RANGÉE DE MADRIERS AVEC POUTRELLES DE FONDATIONS		11	5x90	
		SCREW FOR FOUNDATION - SCHRAUBEN ZUR BEFESTIGUNG FUNDAMENT - VIS DE FIXATIONS DES POUTRELLES DE FONDATIONS		39	5x90	
		SCREW FOR DOOR JAMB - SCHRAUBE FÜR TÜRRAHMEN - VIS DE FIXATION POUR MONTANT DE PORTE		4	5x90	
HS72		SCREW FOR SLIDING WALL TIE - SCHIEBEREGLER FÜR WAND - SABOT MÉTALLIQUE POUR FIXATION MUR		2	6x40	
		SCREW FOR POST HEIGHT ADJUSTMENT - SCHRAUBEN FÜR REGULIERUNGSSCHRAUBE FÜR PFOSTEN - VIS DE FIXATION DE SUPPORT RÉGLABLE DE POTEAU		8	6x50	
		SCREW FOR DOORSTEP - SCHRAUBEN FÜR SWELLE - VIS DE FIXATION DU SEUIL DE PORTE		5	4.5x65	
		ZN NAIL FOR FLOOR FILLET - ZN NÄGEL FÜR FUSSBODENLEISTE - POINTE POUR CORNIERE DE FINITION DU PLANCHER		48	1.4x40	
		HAMMER BLOCK - SCHLAGHOLZ - CALLE DE FRAPPE		1		
		DRIVE NUT TREADED ROD - EINSHLAGMUTTER FÜR GEWINDESTANGE - ÉCROU A FRAPPER POUR TIGE FILITÉE		4		

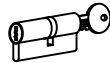
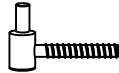
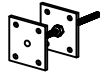
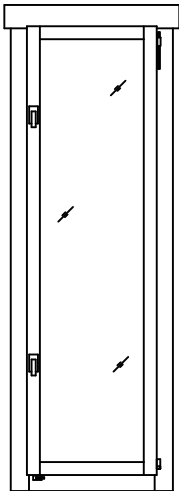
Pos	11.11.2015	Piece list - Stückliste - Liste des pièces Art.Nr. 4419902	11/12	Q.	P (mm)	L (mm)
		NUT FOR TREADED ROD - MUTTER FÜR GEWINDESTANGE - ÉCROU POUR TIGE FILETÉE		4		
		ZN NAIL FOR TERRACE - ZN NÄGEL FÜR TERRASSENBRETT - POINTE POUR PLANCHER DE TERRASSE		204	2.1x50	
		ZN NAIL FOR ROOF - ZN NÄGEL FÜR DACHBRETT - POINTES DE FIXATIONS DES VOLIGES DE TOIT		472	2x50	
		ZN NAIL FOR FLOOR - ZN NÄGEL FÜR FUSSBODENBRETT - CLOUS POUR PLANCHER		379	2x50	
		ZN NAIL FOR ROOFING FELT FILLET - ZN NÄGEL FÜR DACHPAPPENLEISTE - POINTE POUR BAGUETTE FIXATION FEUTRE BITUMEUX		24	2x40	
GS		GABLE SEGMENT - DECKBLATT - LOSANGE DE FINITION		2		
		PLAIN WASHER TREADED ROD - UNTERLEGSSCHEIBE FÜR GEWINDESTANGE - RONDELLE PLATE POUR TIGE FILETÉE		4		
SB		PLAIN WASHER - UNTERLEGSSCHEIBE - RONDELLE PLATE		2		
		SLIDING WALL TIE - SCHIEBEREGLER FÜR WAND - SABOT MÉTALLIQUE POUR FIXATION MUR		2		
		DOOR HANDLE FITTINGS - TÜRGRIFF - SET DE GARNITURES DE SERRURE DE PORTE		2		
		SET OF DOOR LOCK COVERS - SCHLOSSBLENDEN - SET DE GARNITURES DE SERRURE DE PORTE		2		
		CYLINDER LOCK - ZYLINDERSCHLOSS - CYLINDRE DE SERRURE		2	30x35	
		MALE BOLT HINGE FOR DOOR - TÜRRIEGEL - PARTIE MALE DE CHARNIERE DE PORTE		6		
RFP		POST HEIGHT ADJUSTMENT - REGULIERUNGSSCHRAUBE FÜR PFOSTEN - SUPPORT RÉGLABLE DE POTEAU		1		
		WINDOW - FENSTER - FENETRE 560x1780 AK.1.100.PSP DGP		1		

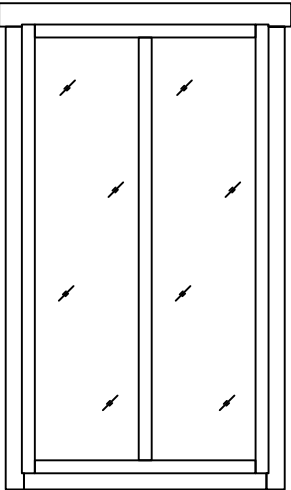
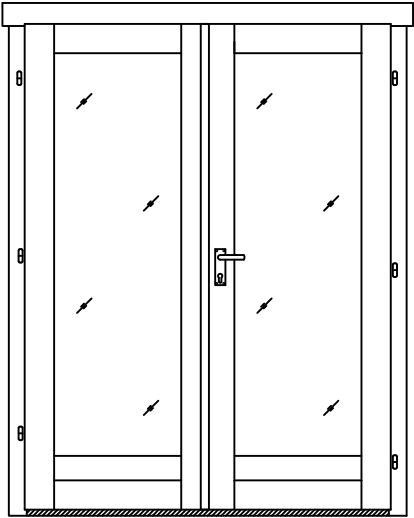
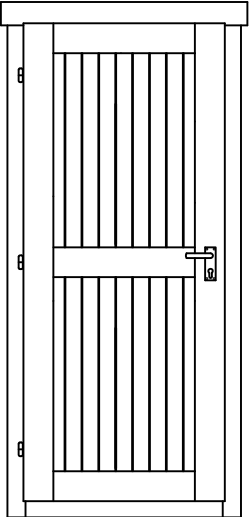
Pos	11.11.2015 Piece list - Stückliste - Liste des pièces Art.Nr. 4419902	12/12	Q.	P (mm)	L (mm)
	WINDOW - FENSTER - FENETRE 1010x1780 TAK.1.100.PM0.e DGP  		2		
	DOOR - TÜR - PORTE 1494x1957 TUK.1.100.PVP.MMb DGP  		1		
	DOOR - TÜR - PORTE 835x1900 UL.2.100.IVV.MMd DGP  		1		