

*Barbados 1*  
*Art. Nr. 442611*  
*1/9*

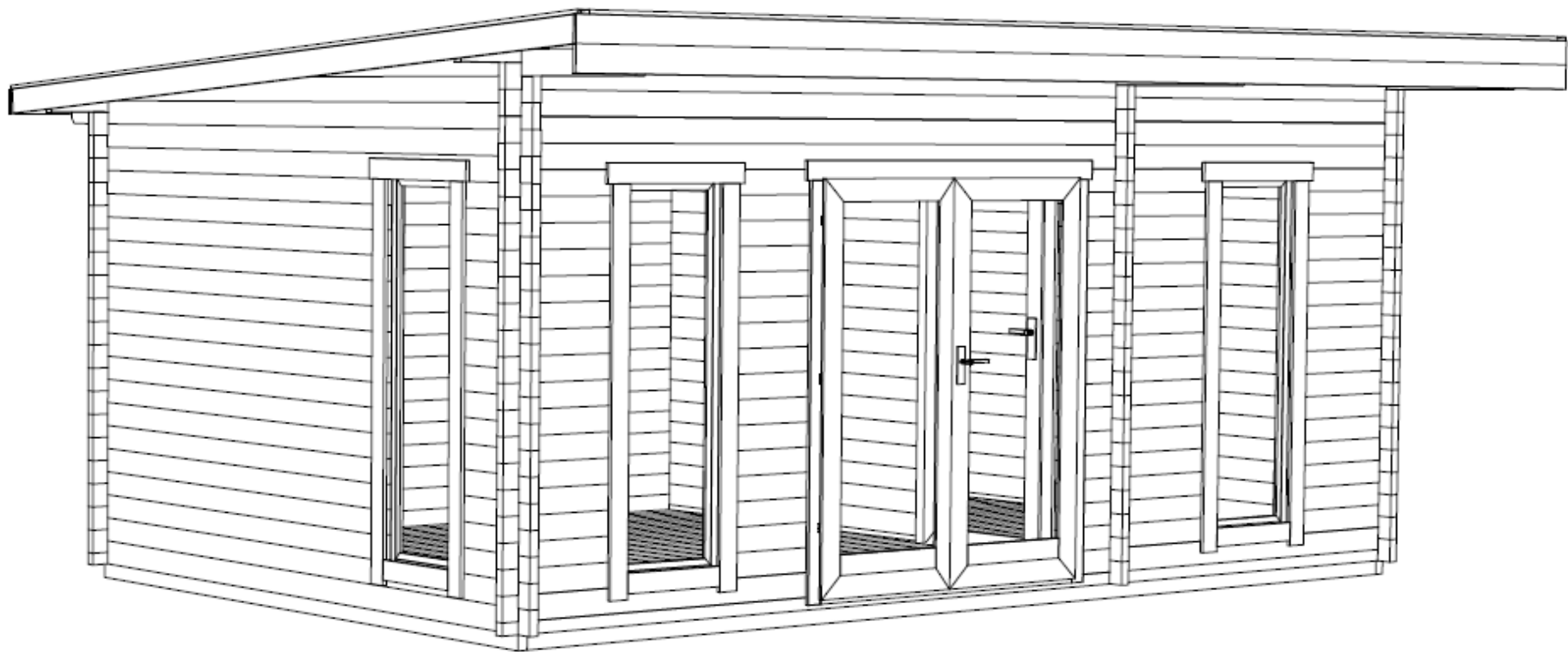

17.03.2014

GROUNDPLAN - GRUNDPLAN - PLAN DE MASSE

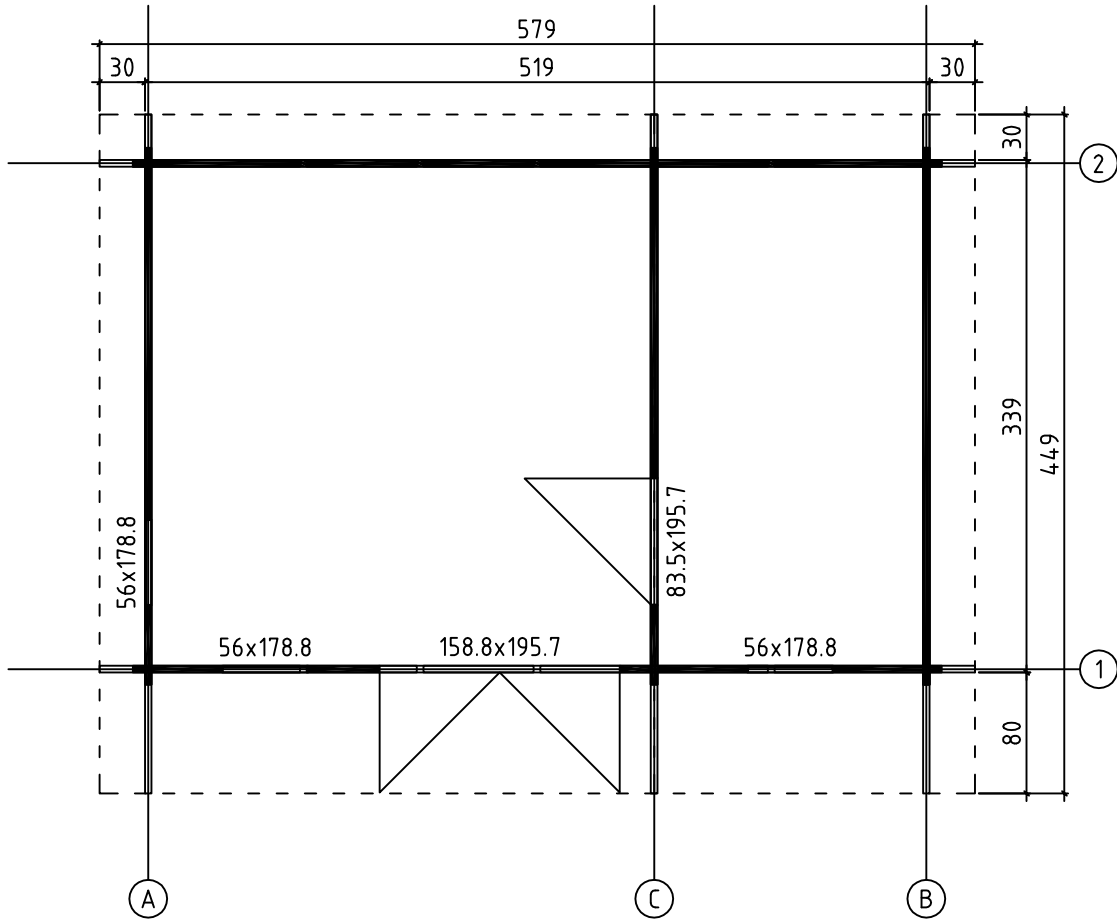

FOUNDATION - FUNDAMENT - FONDATION

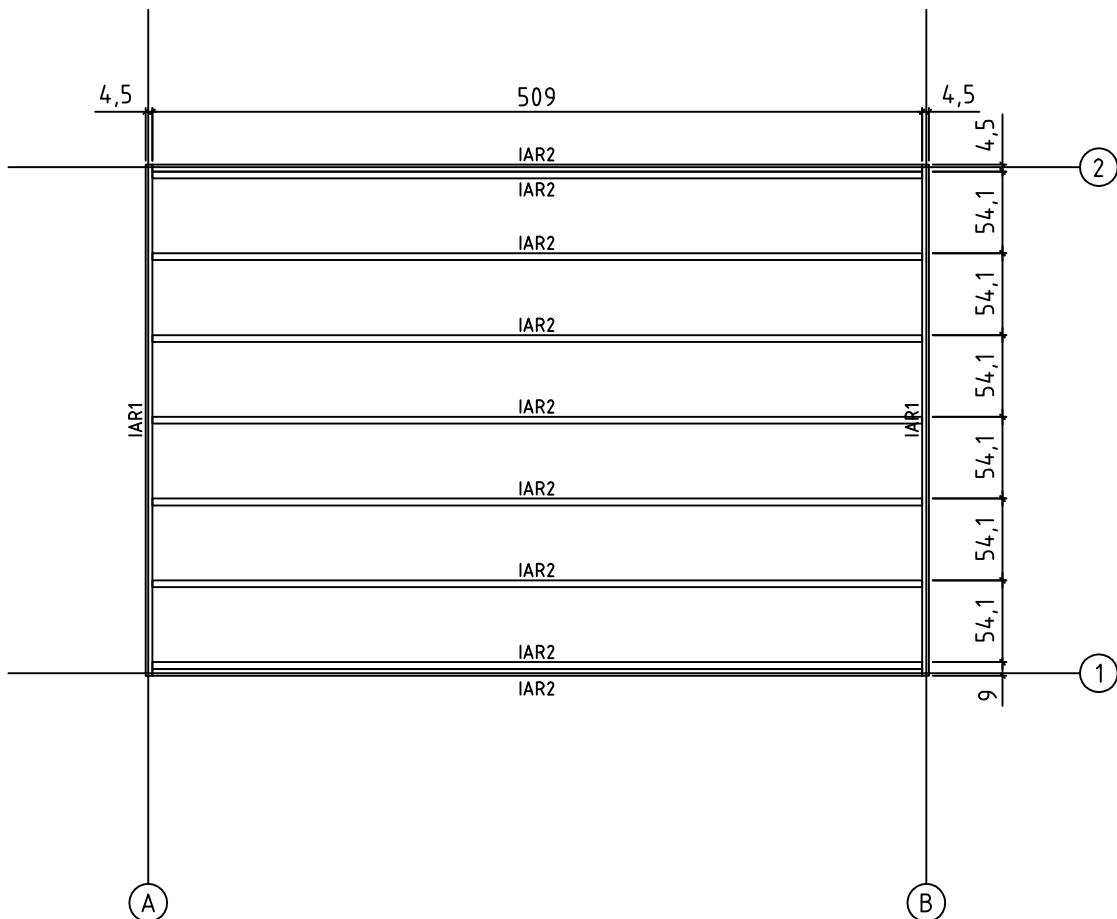



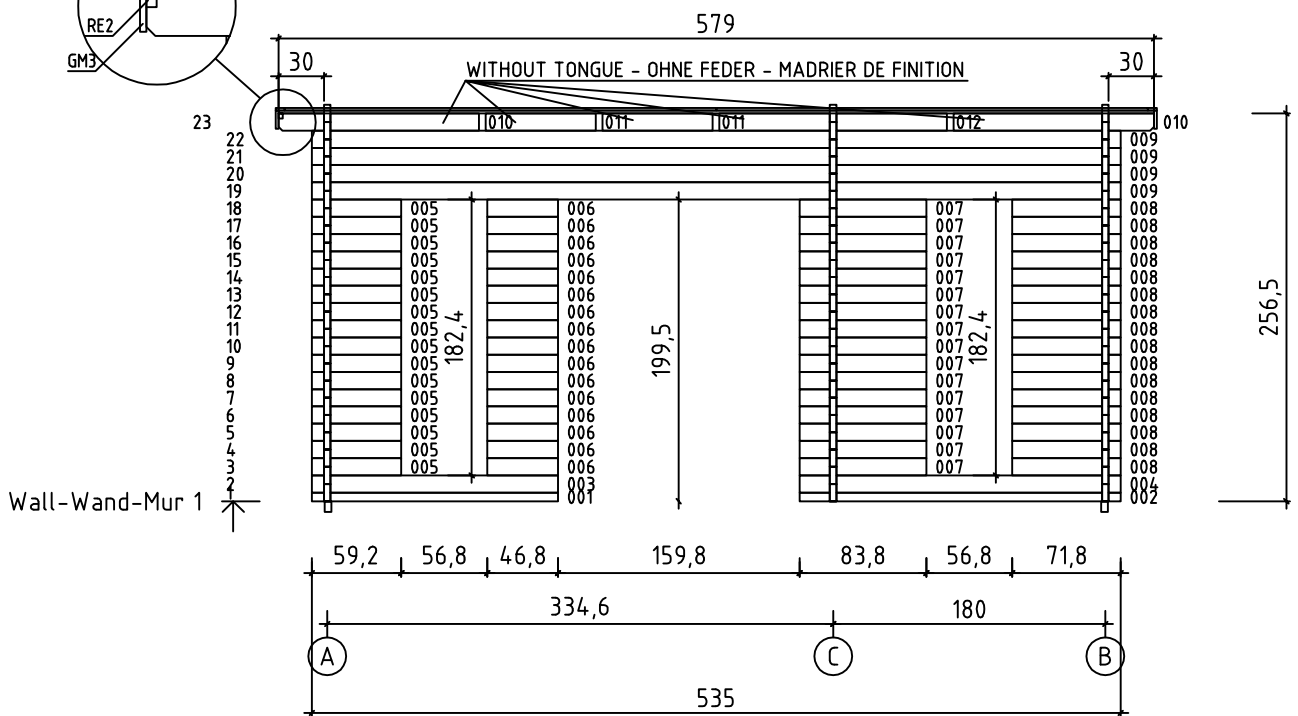
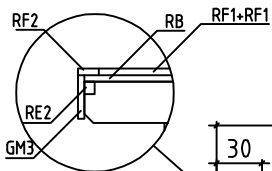
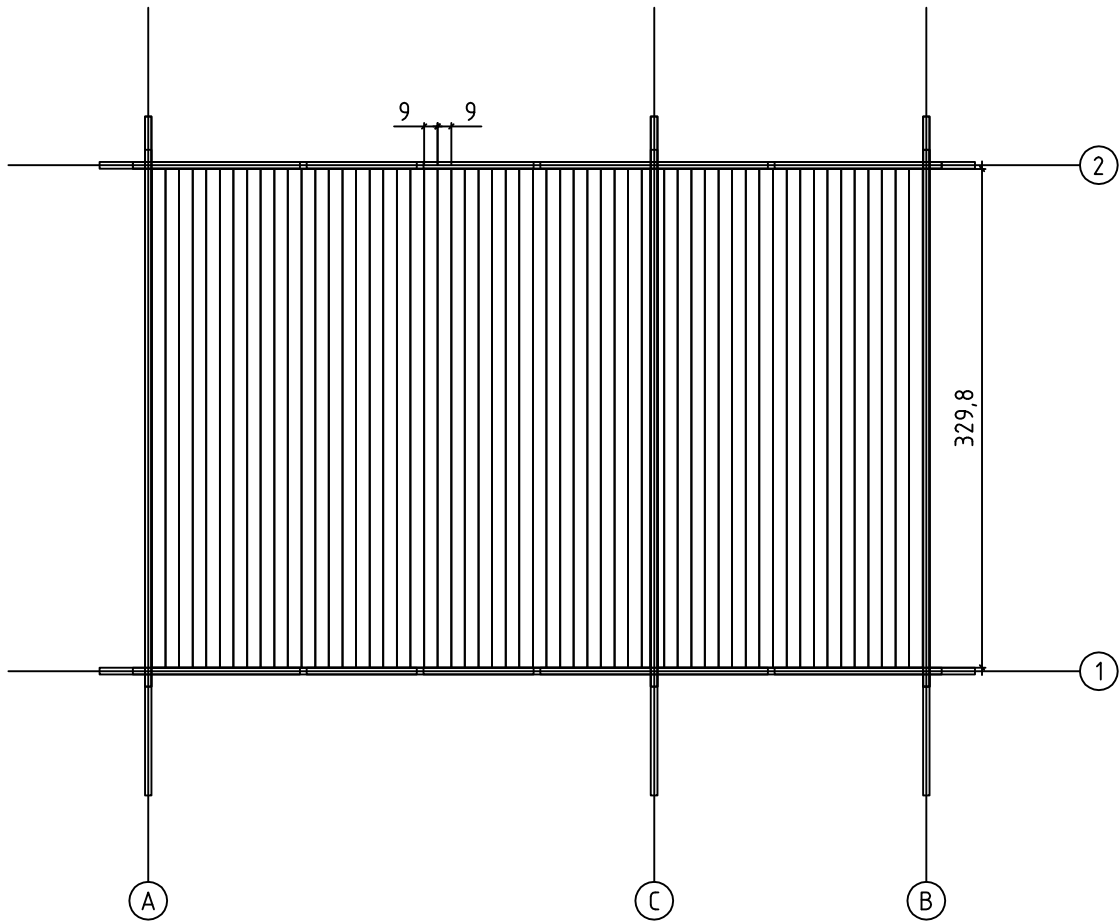

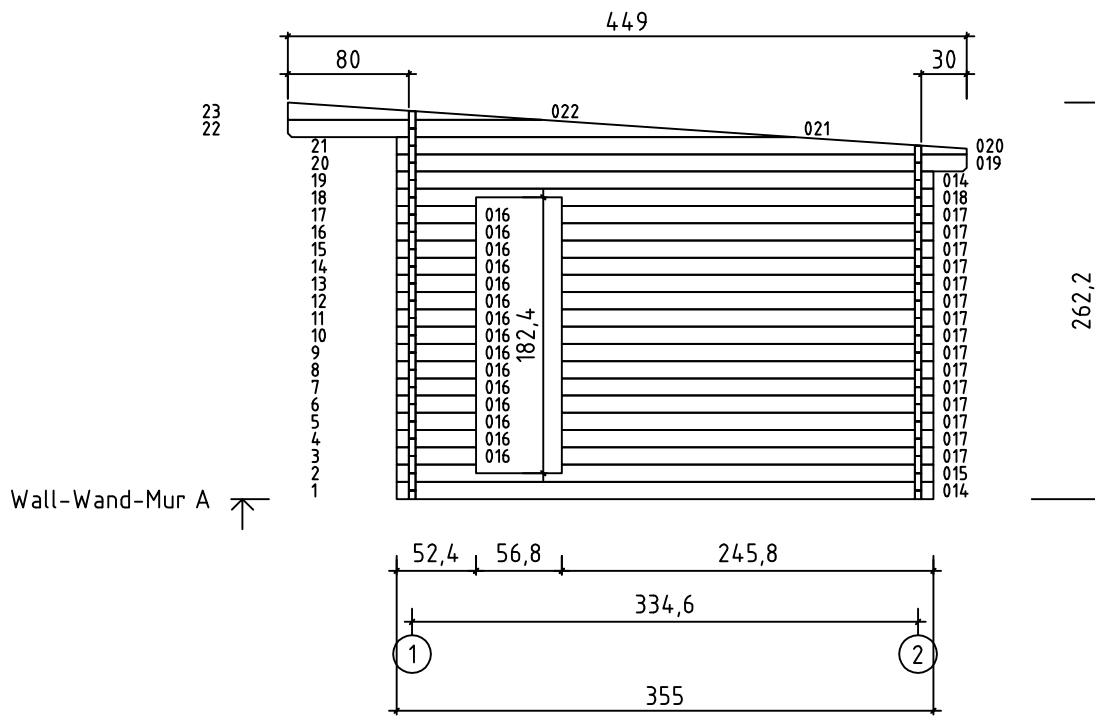
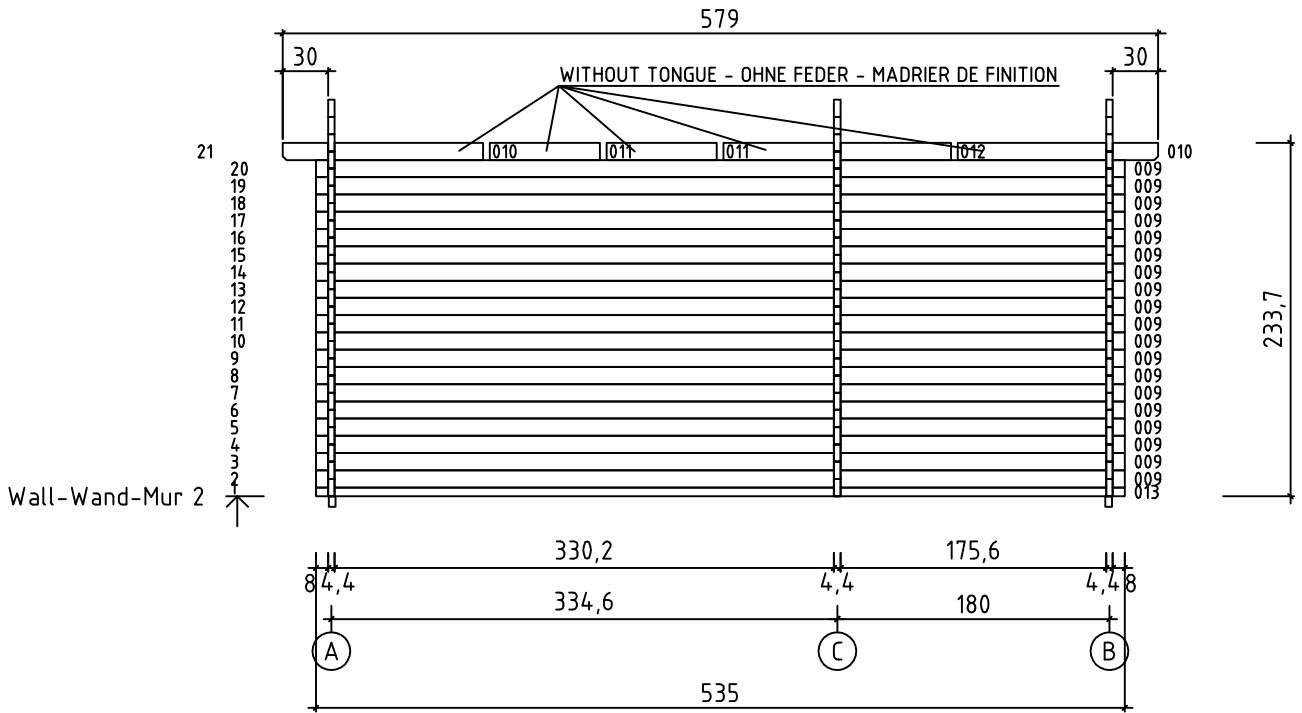

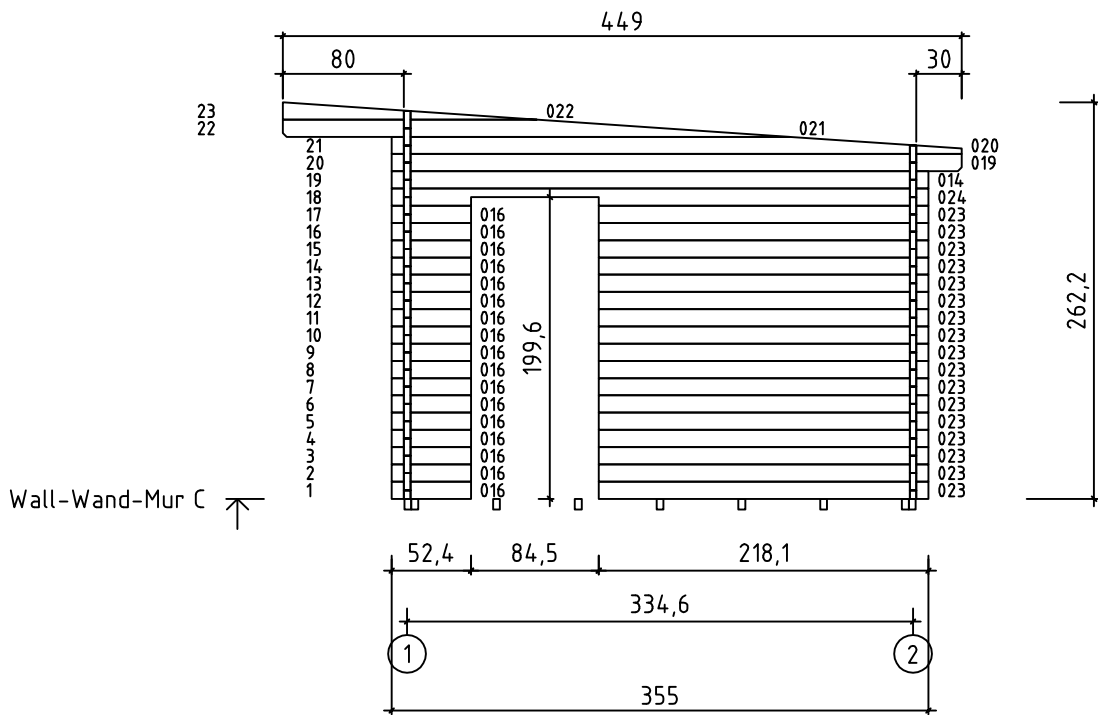
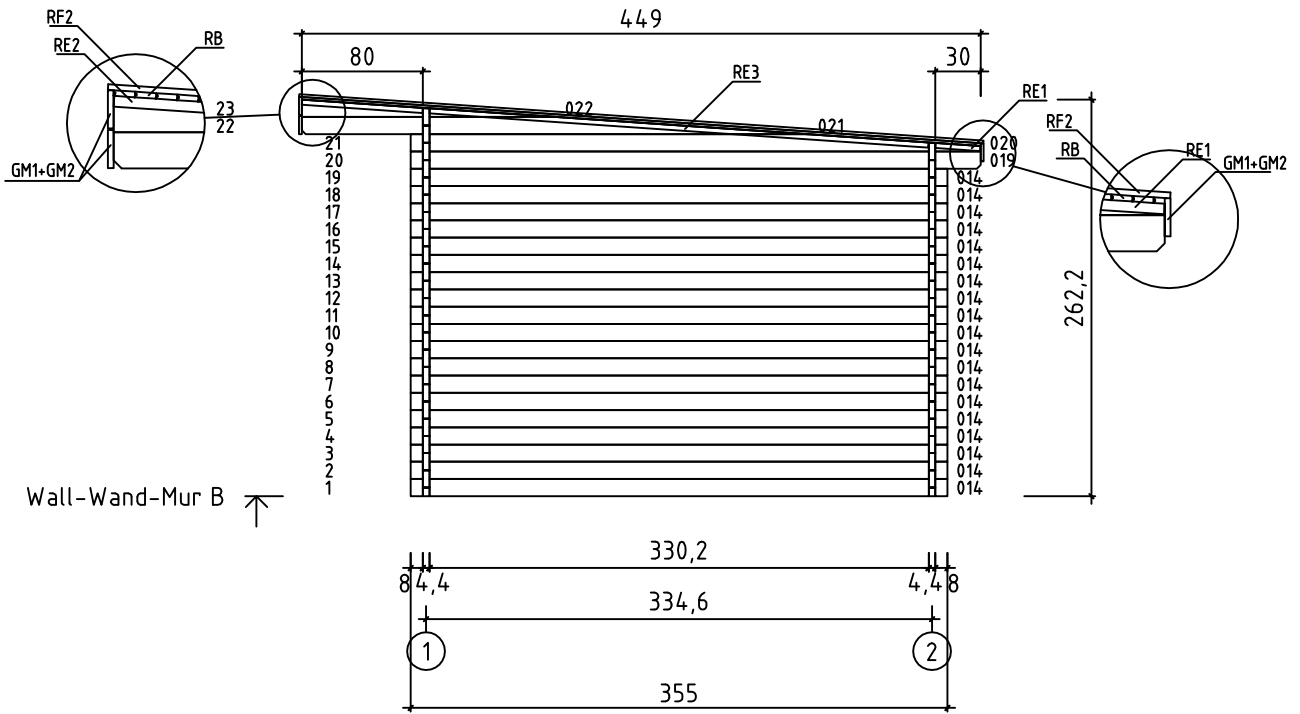

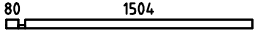
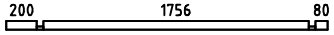
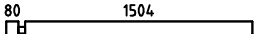
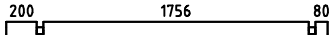

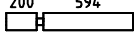
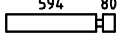
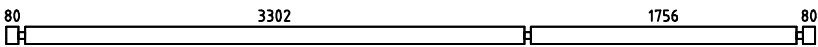
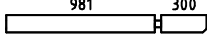
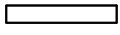
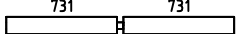
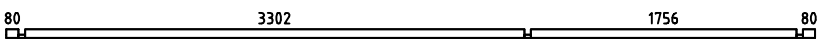
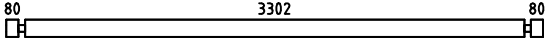
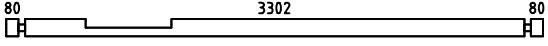

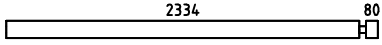
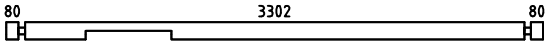
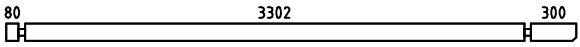
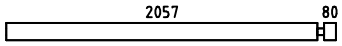
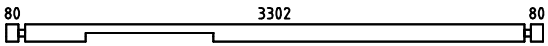
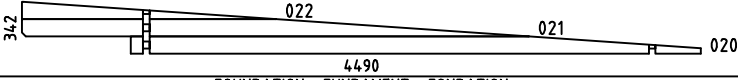
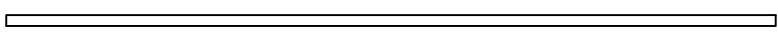
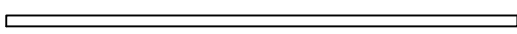
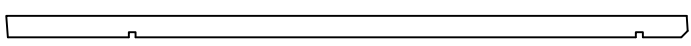







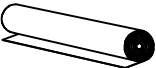

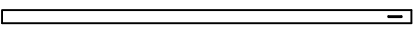
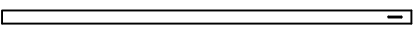
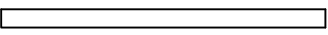
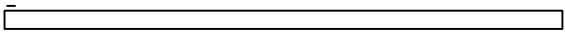
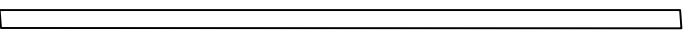

FLOOR BOARDS - FUSSBODENBRETTER - PLAN POSE PLANCHER

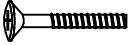









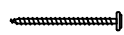
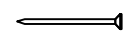
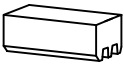

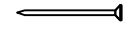
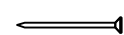
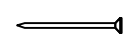

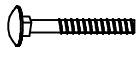
Pos	17.03.2014	Piecelist - Stücklist - Liste des composants Art.Nr. 442611	6/9	Q.	P. (mm)	L. (mm)
001				1	44x57	1628
002				1	44x57	2124
003				1	44x114	1628
004				1	44x114	2124
005				16	44x114	592
006				16	44x114	468
007				16	44x114	838
008				16	44x114	718
009				23	44x114	5350
010				4	44x114	1325
011				4	44x114	729
012				2	44x114	1506
013				1	44x57	5350
014				22	44x114	3550
015				1	44x114	3550
016				32	44x114	524
017				15	44x114	2458
018				1	44x114	3550
019				3	44x114	3770
023				17	44x114	2181
024				1	44x114	3550
WA-1 WB-1 WC-1		FOUNDATION - FUNDAMENT - FONDATION		1 1 1		
IAR2		FOUNDATION - FUNDAMENT - FONDATION		9	45x70	5090
IAR1		FOUNDATION - FUNDAMENT - FONDATION		2	45x70	3380
SR1		RAFTER - DACHSPARREN - CHEVRON		4	44x140	4510

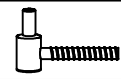
Pos	17.03.2014	Piecelist - Stücklist - Liste des composants Art.Nr. 442611	7/9	Q.	P. (mm)	L. (mm)
		FLOOR BOARDS - FUSSBODENBRETTER - LAME DE PLANCHER		57	90x18	3298
RB		ROOF BOARDS - DACHBRETTER - VOLIGES		51	90x18	3668
RB		ROOF BOARDS - DACHBRETTER - VOLIGES		51	90x18	2122
		FLOOR FILLET-FUSSBODENLEISTE - CORNIERE DE FINITION DU PLANCHER			18x18	23.29
RF1		ROOFING FELT FILLET - DACHPAPPENLEISTE - BAGUETTE DE FIXATION DU FEUTRE BITUMEUX		2	18x58	2853
RF2		ROOFING FELT FILLET - DACHPAPPENLEISTE - BAGUETTE DE FIXATION DU FEUTRE BITUMEUX		2	18x58	4536
		ROOFING FELT (STRIP) - DACHPAPPE (BAHNEN) - FEUTRE BITUMEUX (BANDE)		5		5900
RE1		ROOF EDGE REINFORCEMENT - DACHRANDVERSTÄRKUNG - CORNIERE DE RENFORT DE BORD DE TOIT		2	28x34	297
RE2		ROOF EDGE REINFORCEMENT - DACHRANDVERSTÄRKUNG - CORNIERE DE RENFORT DE BORD DE TOIT		2	28x34	800
RE3		ROOF EDGE REINFORCEMENT - DACHRANDVERSTÄRKUNG - CORNIERE DE RENFORT DE BORD DE TOIT		2	28x34	3306
		STORM PROTECTION - STURMLEISTE - - LATTE ANTI-TEMPETE		2	22x45	2250
		STORM PROTECTION - STURMLEISTE - - LATTE ANTI-TEMPETE		2	22x45	2480
GM1		GABLE MOULDING - GIEBELLEISTE - PLANCHE DE RIVE		3	18x120	2145
GM2		GABLE MOULDING - GIEBELLEISTE - - PLANCHE DE RIVE		3	18x120	3691
GM3		GABLE MOULDING - GIEBELLEISTE - - PLANCHE DE RIVE		2	18x120	4510
		WINDOW HANDLE FITTINGS - FENSTERGRIFF - POIGNÉE D'OUVERTURE DE FENETRE		6		
		BOLT FOR WINDOW HANDLE FITTINGS - BOLZEN FÜR FENSTERGRIFF BESCHLAG - BOULON POUR POIGNÉE D'OUVERTURE DE FENETRE		12		
		SCREW FOR ROOF EDGE REINFORCEMENT - SCHRAUBEN FÜR DACHRANDVERSTÄRKUNG - VIS POUR RENFORT DE BORD DE TOIT		24	4x40	
		SCREW FOR ROOF BEAMS - SCHRAUBEN FÜR DACHBALKEN - VIS POUR PANNE DE TOIT		14	5x90	
		SCREW FOR 1. WALL BEAM - SCHRAUBE FÜR 1. BOHLENREIHE - VIS DE FIXATION DES FONDATIONS		8	5x90	
		SCREW FOR GABLE MOULDING - SCHRAUBEN FÜR GIEBELLEISTE - VIS DE FIXATION POUR PLANCHE DE RIVE		72	3.5x50	
		SCREW FOR DOOR FILLET - SCHRAUBE ZUR BEFESTIGUNG TÜRLEISTE - VIS D'ASSEMBLAGE DU CADRE DE PORTE		5	3x30	
		SCREW FOR GABLE - SCHRAUBEN FÜR GIEBEL - VIS POUR FIXATION DES PIGNONS		12	5x120	
		SCREW FOR FUNDAMENT - SCHRAUBEN ZUR BEFISTIGUNG FUNDAMENT - VIS POUR FONDATION		24	5x90	
		SCREW FOR DOOR JAMB - SCHRAUBE FÜR TÜRRAHMEN - VIS DE FIXATION POUR MONTANT DE PORTE		4	5x90	

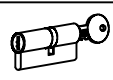
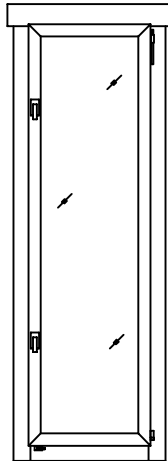
Pos	17.03.2014	Piecelist - Stücklist - Liste des composants Art.Nr. 442611	8/9	Q.	P. (mm)	L. (mm)
		SCREW FOR POS. 010, 011 AND 012 - SCHRAUBEN FÜR POS 010, 011 UND 012 - VIS DE FIXATION POUR MONTANT DES POS 010, 011, 012		12	6x180	
		SCREW FOR DOORSTEP - SCHRAUBEN FÜR SWELLE - VIS DE FIXATION DU SEUIL DE PORTE		5	4.5x65	
		ZN NAIL FOR FLOOR FILLET - ZN NÄGEL FÜR FUSSBODENLEISTE - POINTE POUR CORNIERE DE FINITION DU PLANCHER		48	1.4x40	
		HAMMER BLOCK - SCHLAGHOLZ - CALLE DE FRAPPE		1		
		NUT FOR STORM PROTECTION - SCHRAUBENMUTTER FÜR STURMLEISTE - ÉCROU POUR LAME ANTI-TEMPETE		8	D8	
		ZN NAIL FOR ROOF - ZN NÄGEL FÜR DACHBRETTER - POINTES DE FIXATIONS DES VOLIGES DE TOIT		430	2x50	
		ZN NAIL FOR FLOOR - ZN NÄGEL FÜR FUSSBODENBRETTER - CLOUS POUR PLANCHER		400	2x50	
		ZN NAIL FOR ROOFING FELT FILLET - ZN NÄGEL FÜR DACHPAPPENLEISTE - POINTE POUR BAGUETTE FIXATION FEUTRE BITUMEUX		34	2x40	
		ROOFING NAILS FOR ROOFING FELT - NÄGEL FÜR DACHPAPPE - POINTE DE FIXATION POUR FEUTRE BITUMEUX		235	2.8x15	
		BOLT FOR STORM PROTECTION - BOLZEN FÜR STURMLEISTE - VIS POUR LAME ANTI-TEMPETE		8	8x80	
		WASHER FOR STORM PROTECTION - DICHTSCHEIBE FÜR STURMLEISTE - RONDELLE POUR LAME ANTI-TEMPETE		8	D8	
		SET OF DOOR LOCK COVERS - SCHLOSSBLENDEN - SET DE GARNITURES DE SERRURE DE PORTE		2		
		MALE BOLT HINGE FOR DOOR - TÜRRIEGEL - PARTIE MALE DE CHARNIERE DE PORTE		6	16x44/52	
		DOOR HANDLE FITTINGS - TÜRGRIF - SET DE GARNITURES DE SERRURE DE PORTE		2		
		CYLINDER LOCK - ZYLINDERSCHLOSS - CYLINDRE DE SERRURE		2	30x35	
		WINDOW - FENSTER - FENETRE 560x1788 DGP	AK.1.100.PSP	3		
						

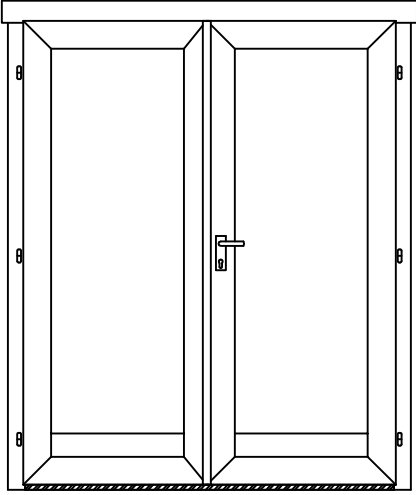
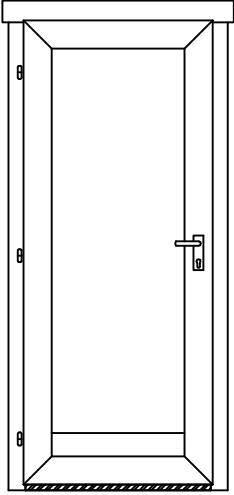

Pos	17.03.2014 Piecelist - Stücklist - Liste des composants Art.Nr. 442611	9/9	Q.	P. (mm)	L. (mm)
	DOOR - TÜR - PORTE 1588x1957 DGP  	TUK.1.100.PVP.MM	1		
	DOOR - TÜR - PORTE 835x1957 DGP  	UK.1.100.PVV.MM	1		