

LYNDHURST 70

Art.No. 7011902

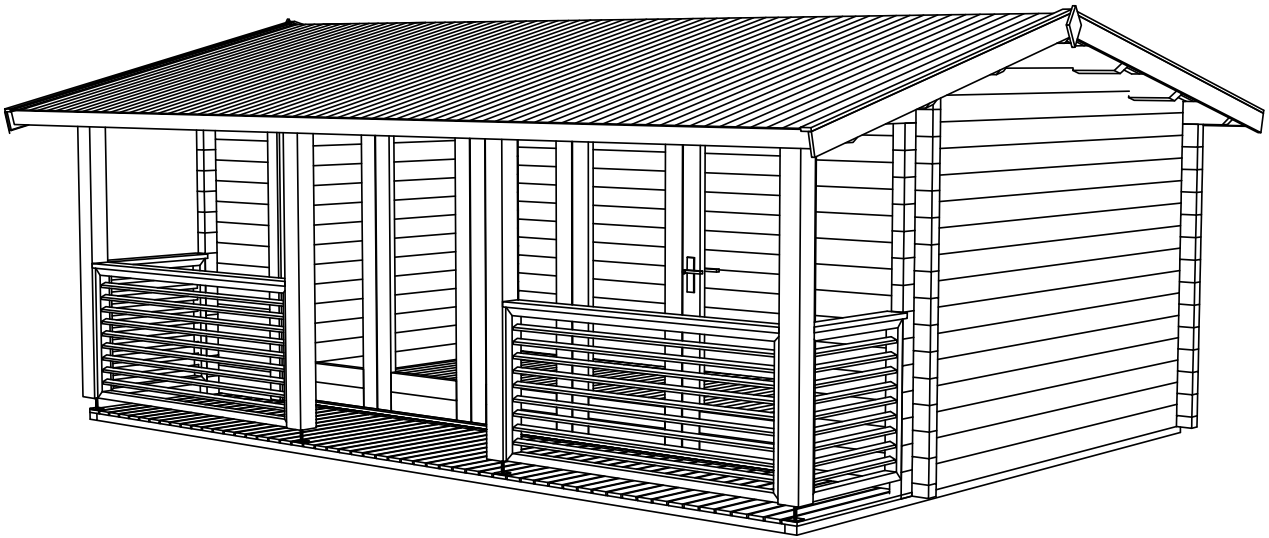

LYNDHURST 70, Art.No.7011902
GROUNDPLAN - GRUNDPLAN - PLAN DE MASSE

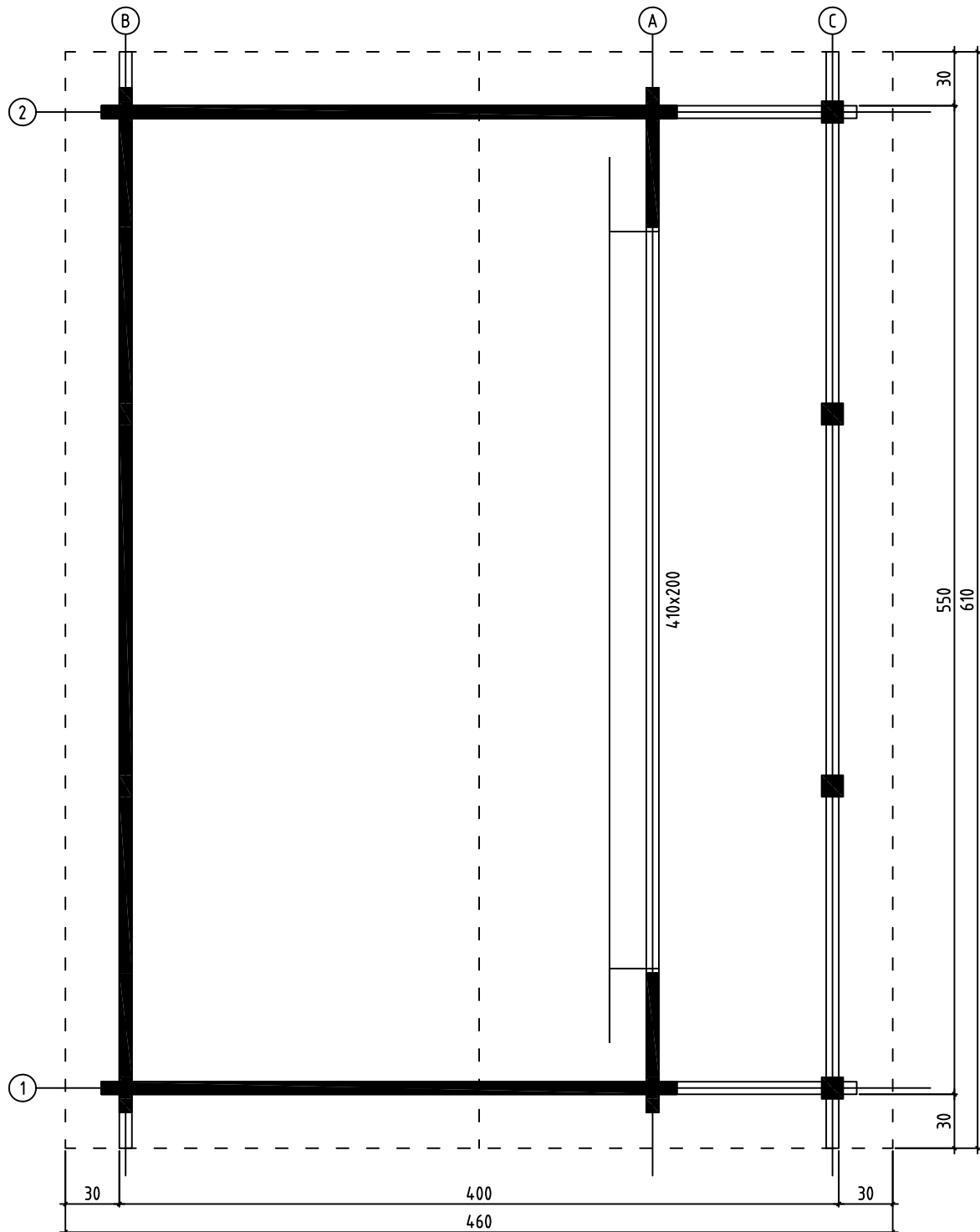

LYNDHURST 70, Art.No.7011902
FOUNDATION - FUNDAMENT - FONDATION

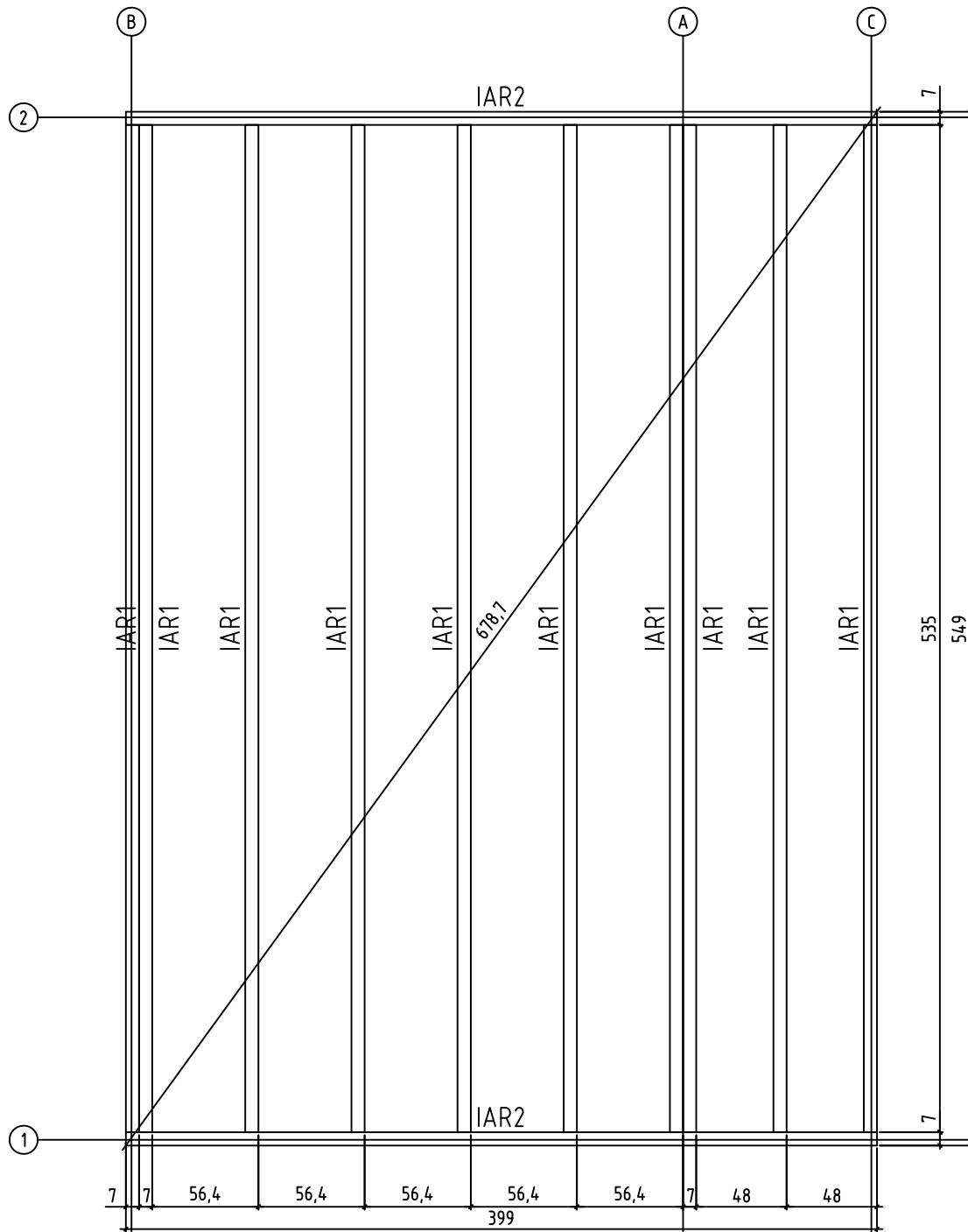

LYNDHURST 70, Art.No.7011902
FLOOR BOARDS - FUSSBODENBRETTER - PLAN POSE PLANCHER

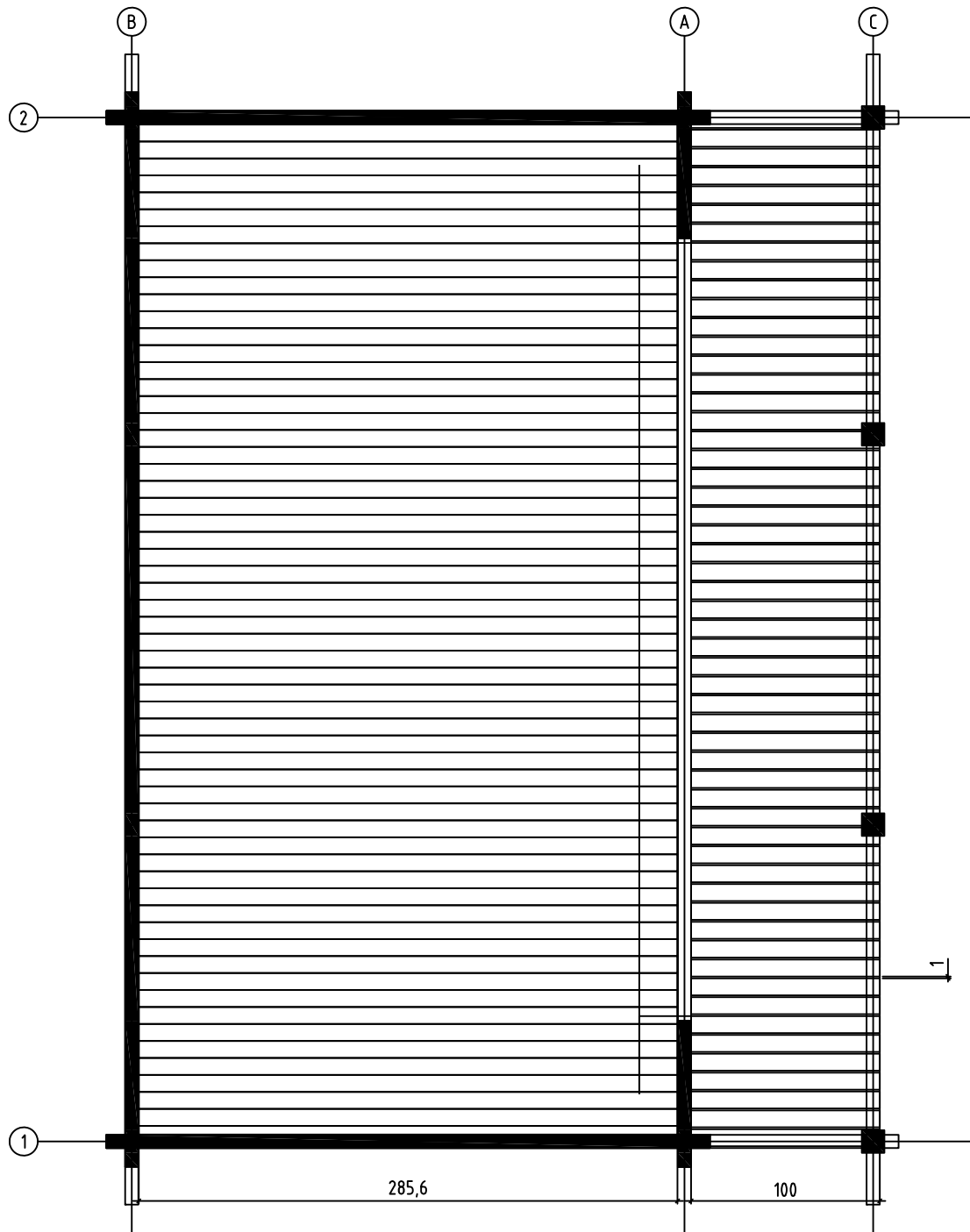

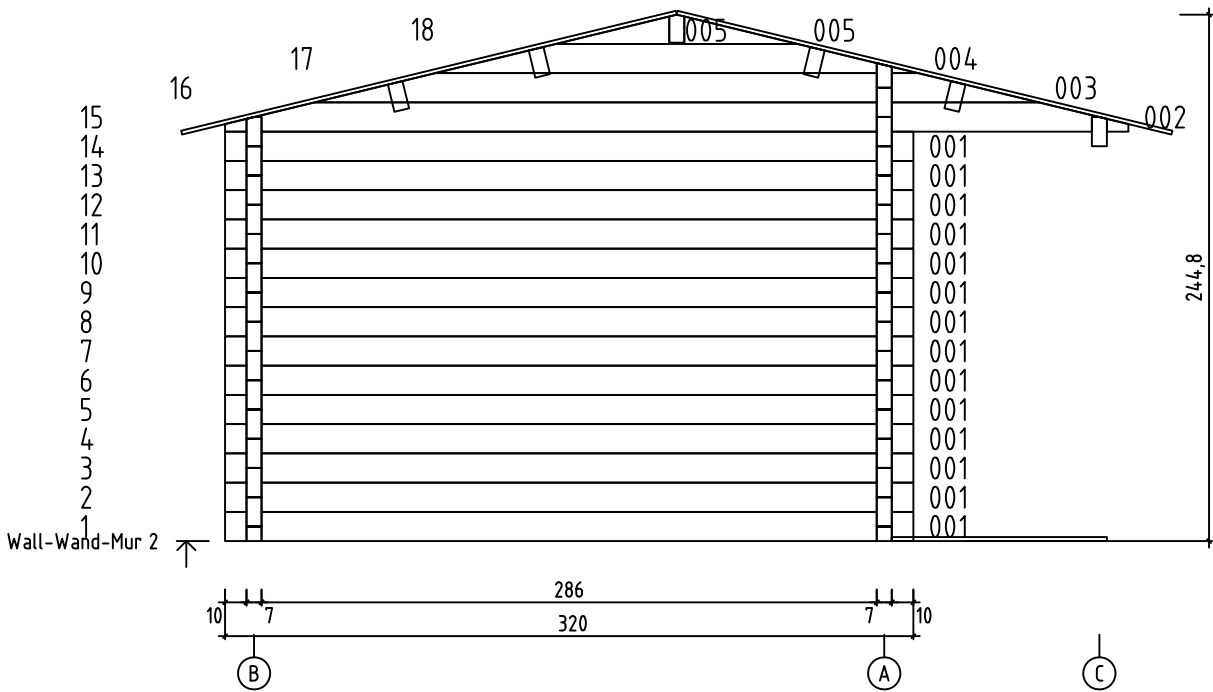
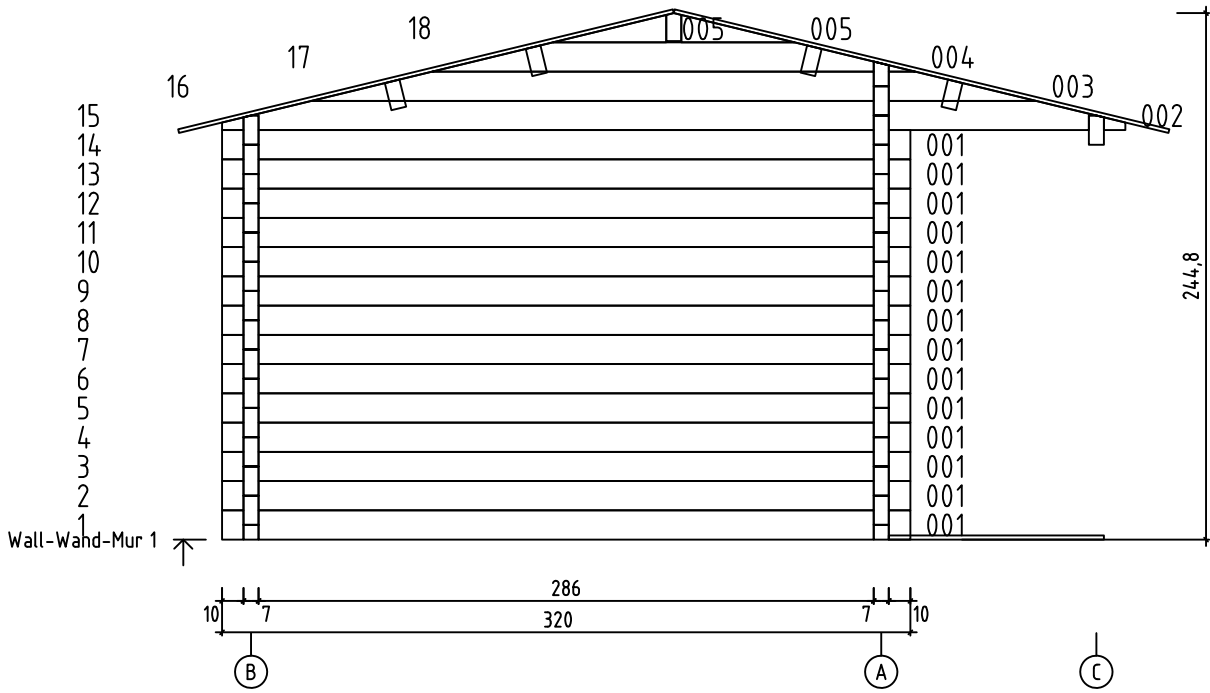

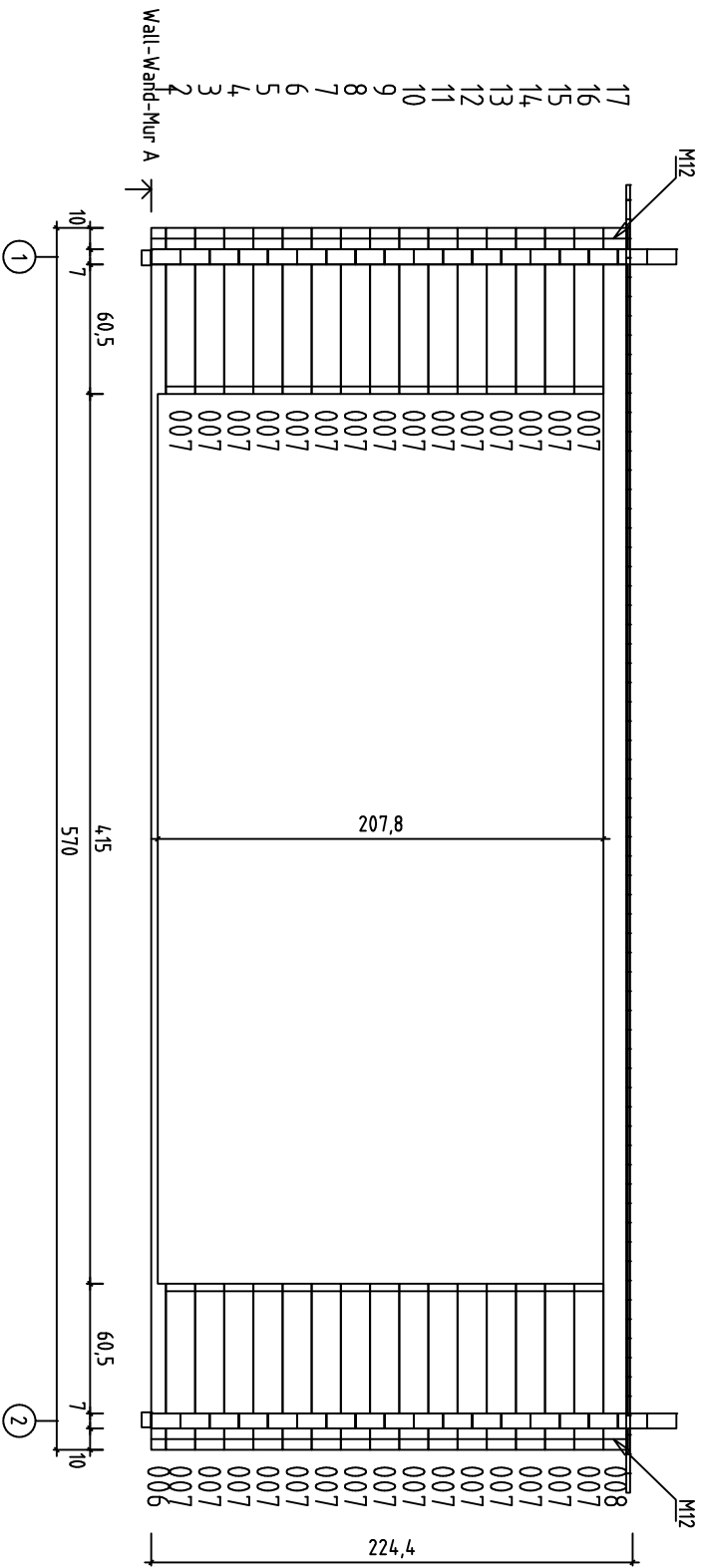

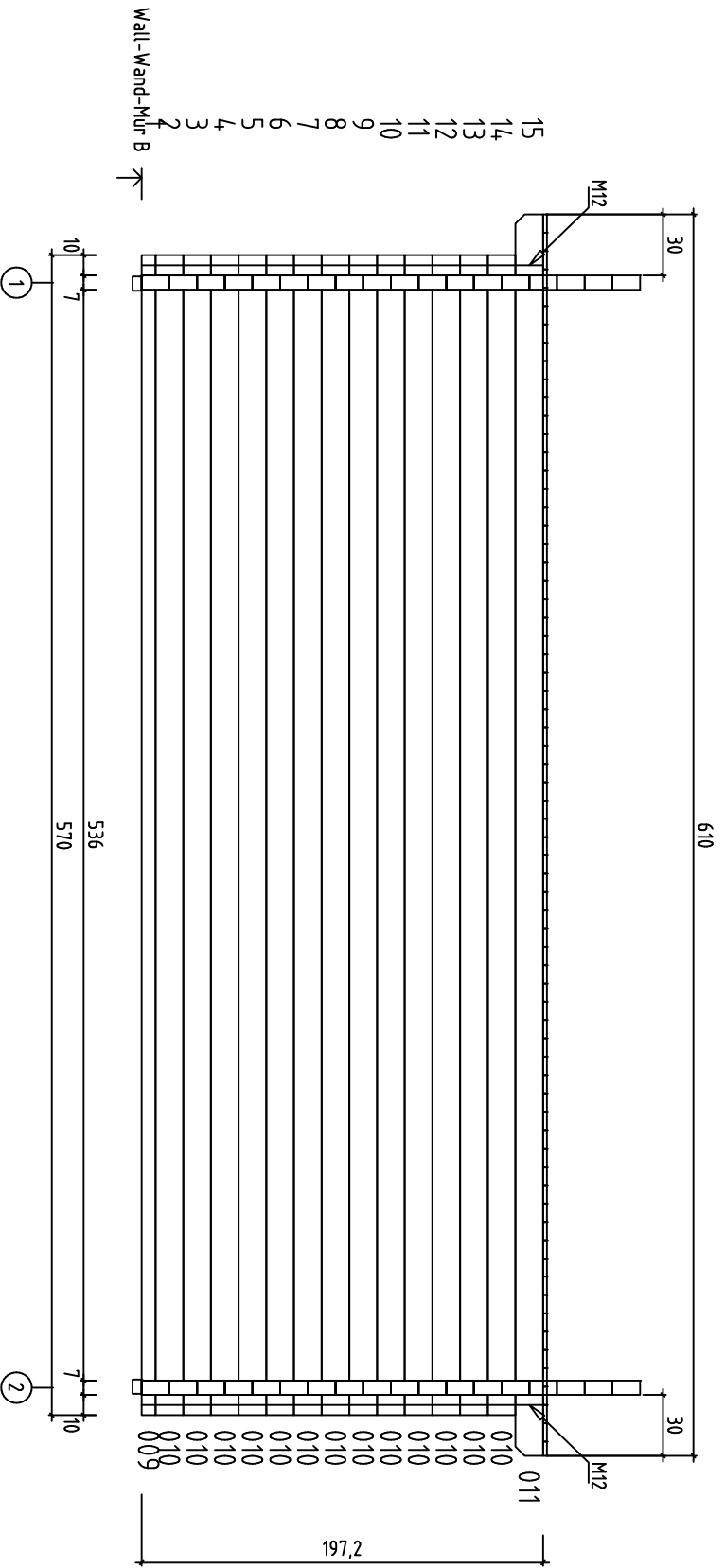

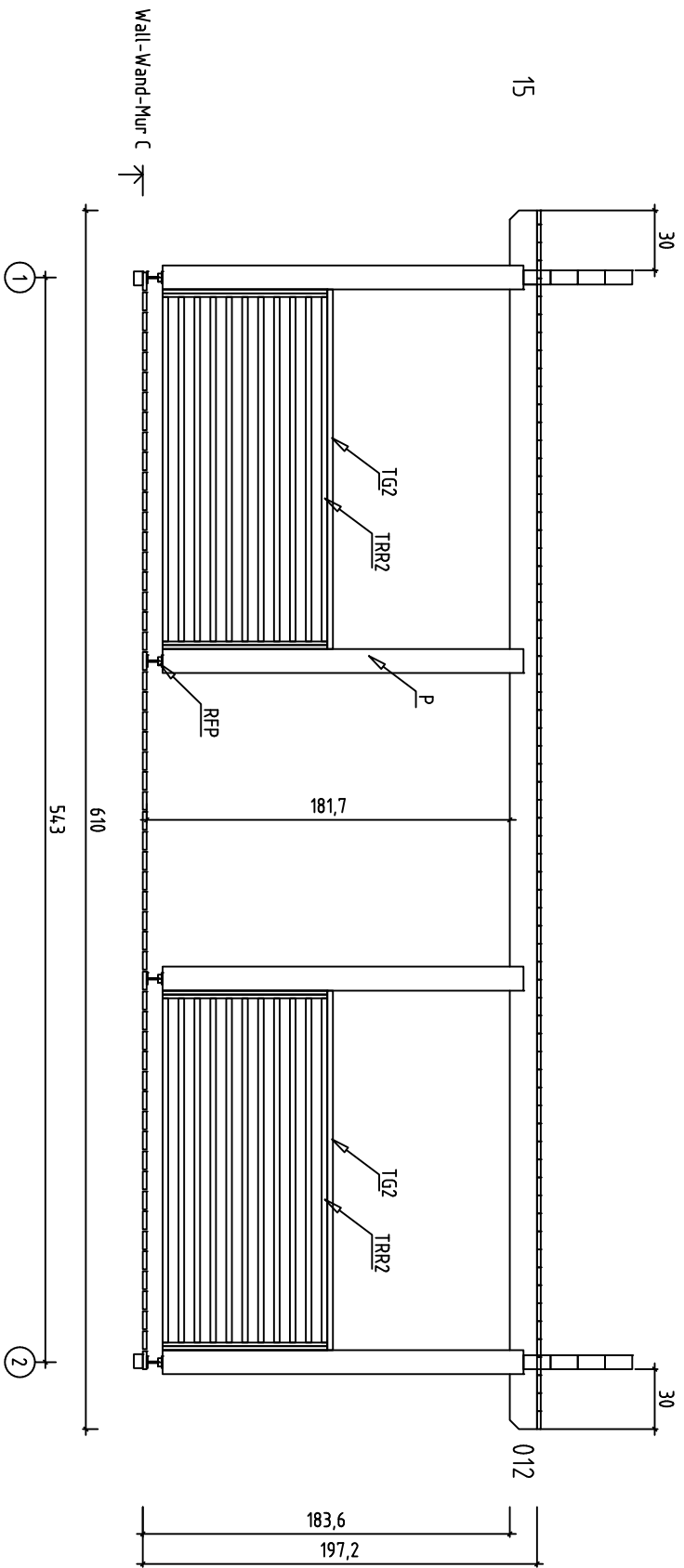

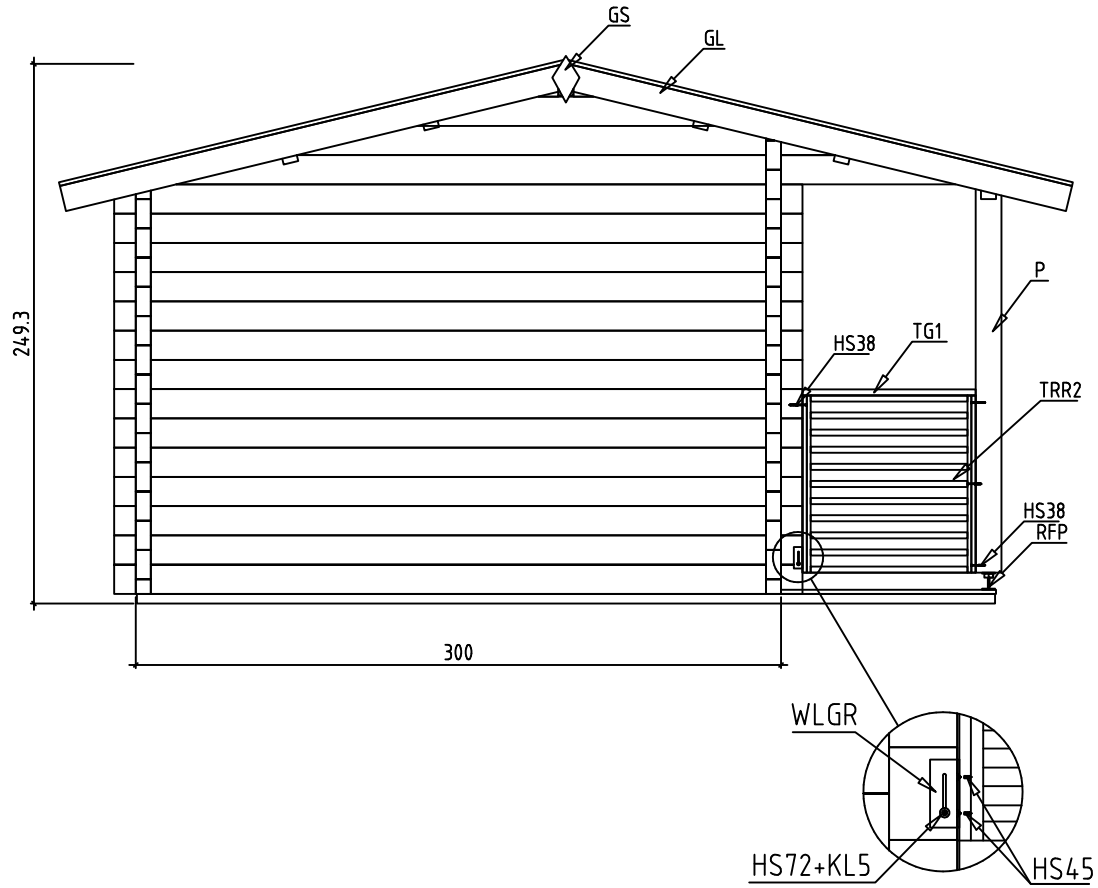

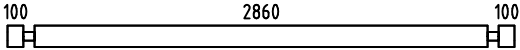
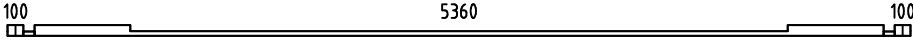
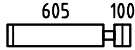
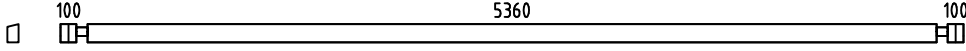
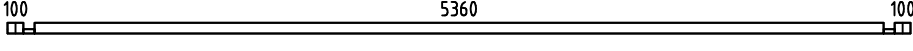
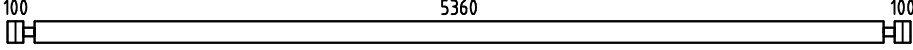
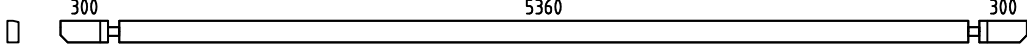
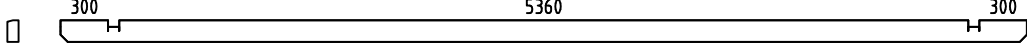
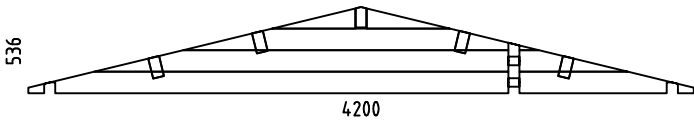
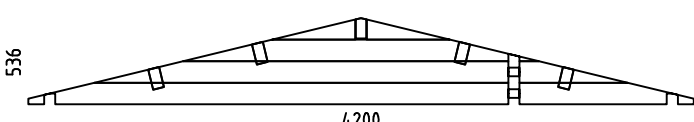
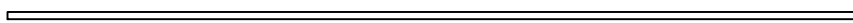

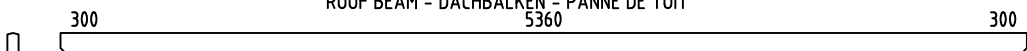
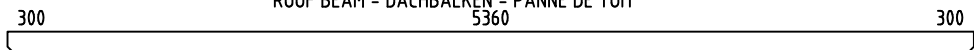





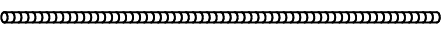



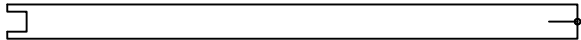

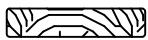
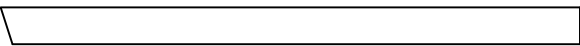



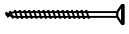
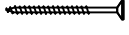

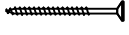
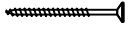

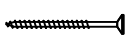



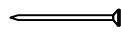
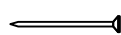

Pos	LYNDHURST 70, Art.No.7011902 Piece list - Stückliste - Liste des pieces	Q.	P (mm)	L (mm)
001		28	70x136	3200
006		1	70x68	5700
007		30	70x136	775
008		1	70x115	5700
009		1	70x68	5700
010		13	70x136	5700
011		1	70x136	6100
012		1	70x136	6100
W1-1		1		
W2-1		1		
IAR1	FOUNDATION - FUNDAMENT - FONDATION 	10	70x45	5350
IAR2	FOUNDATION - FUNDAMENT - FONDATION 	2	70x45	3990
PR1	ROOF BEAM - DACHBALKEN - PANNE DE TOIT 	1	70x140	6100
A-PR1	ROOF BEAM - DACHBALKEN - PANNE DE TOIT 	4	70x140	6100
	FLOOR BOARDS - FUSSBODENBRETTER - LAME DE PLANCHER 	60	90x18	2856
	ROOF BOARDS - DACHBRETTER - VOLIGES 	136	90x18	2367
SV	TERRACE BOARDS - TERRASSENBRETTER - PLANCHER DE TERRASSE 	55	90x19	1000
	FLOOR FILLET-FUSSBODENLEISTE - CORNIERE DE FINITION DU PLANCHER 		18x18	16.5 m.
DPL	ROOFING FELT FILLET - DACHPAPPENLEISTE - BAGUETTE DE FIXATION DU FEUTRE BITUMEUX 	4	18x58	2417
M12	TREADED ROD M12 - GEWINDESTANGE M12 - TIGE FILETÉE M12 	2		250
M12	TREADED ROD M12 - GEWINDESTANGE M12 TIGE FILETÉE M12 	4		2000
LPL	FIXING FILLET - FIXIRUNGSLEISTE - PROFIL DE FIXATION 	2	20x70	2020
LPL	FIXING FILLET - FIXIRUNGSLEISTE - PROFIL DE FIXATION 	1	20x70	4100

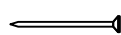
Pos	LYNDHURST 70, Art.No.7011902 Piece list - Stückliste - Liste des pieces	Q.	P (mm)	L (mm)
P	POST - PFOSTEN - POTEAU 	4	120x120	1805
TB	EAVES BOARD - TRAUFBRETT - BANDEAU DE TOIT 	4	18x90	3050
DRV	ROOF EDGE REINFORCEMENT - DACHRANDVERSTÄRKUNG - CORNIERE DE RENFORT DE BORD DE TOIT 	4	28x34	3050
TBE6	FIXING FILLET FOR DOOR - FIXIRUNGSLEISTE FÜR TÜR - PROFIL DE FIXATION DES PORTES 	2	28x34	1960
TG1	GUARD-RAIL FOR TERRACE - TERRASSENGELÄNDER - MAIN COURANTE DE TERRASSE 	2	28x120	805
TG2	GUARD-RAIL FOR TERRACE - TERRASSENGELÄNDER - MAIN COURANTE DE TERRASSE 	2	28x120	1800
GL	GABLE MOULDING - GIEBELLEISTE PLANCHE DE RIVE 	4	18x120	2417
KL4	LENGTHENING BOLT FOR TREADED ROD - VERLÄNGERUNGSMUTTER FÜR GEWINDESTANGE - MANCHON DE RACCORDEMENT DE TIGE FILETÉE 	2		
KL1	DRIVE NUT TREADED ROD - EINSHLAGMUTTER FÜR GEWINDESTANGE - ÉCROU A FRAPPER POUR TIGE FILITÉE 	4		
KL2	NUT FOR TREADED ROD - MUTTER FÜR GEWINDESTANGE - ÉCROU POUR TIGE FILETÉE 	4		
KL3	PLAIN WASHER TREADED ROD - UNTERLEGSSCHEIBE FÜR GEWINDESTANGE - RONDELLE PLATE POUR TIGE FILETÉE 	4		
HS12	SCREW FOR GABLE SEGMENT - SCHRAUBEN FÜR DECKBLATT - VIS POUR FIXATION LOSANGE DE FINITION 	4	3.5x35	
HS83	SCREW FOR FIXING FILLET - SCHRAUBEN FÜR FIXIRUNGSLEISTE - VIS POUR PROFIL DE FIXATION 	19	3.5x50	
HS84	SCREW FOR FIXING FILLET - SCHRAUBEN FÜR FIXIRUNGSLEISTE - VIS POUR PROFIL DE FIXATION 	10	3.5x50	
HS16	SCREW FOR GABLE MOULDING - SCHRAUBEN FÜR GIEBELLEISTE - VIS DE FIXATION POUR PLANCHE DE RIVE 	32	3.5x50	
HS38	SCREW FOR FIXING TERRACE RAILING - SCHRAUBE FÜR TERRASSE VIS DE FIXATION DE GARDE-CORPS DE TERRASSE 	18	4.5x80	
HS45	SCREW FOR SLIDING WALL TIE - SCHRAUBEN FÜR WAND SCHIEBEREGLER - VIS POUR FIXATION ÉQUERRE MÉTALLIQUE AU PARAVENT 	8	4x20	
HS32	SCREW FOR EAVES BOARDS - SCHRAUBEN FÜR TRAUFBRETT - VIS DE FIXATION POUR BANDEAU DE TOIT 	28	4x40	
HS26	SCREW FOR ROOF EDGE REINFORCEMENT - SCHRAUBEN FÜR DACHRANDVERSTÄRKUNG - VIS POUR RENFORT DE BORD DE TOIT 	28	4x40	
HS34	SCREW FOR POST - SCHRAUBEN FÜR PFOSTEN - VIS DE FIXATION DES POTEAUX 	8	4x60	
HS30	SCREW FOR TERRACE REAR BOARDS - SCHRAUBEN FÜR TERRASSENRAND - VIS DE FIXATION POUR MAIN COURANTE DE TERRASSE 	18	4x60	
HS40	SCREW FOR 1. WALL BEAM - SCHRAUBE FÜR 1. BOHLENREIHE - VIS DE FIXATION DES FONDATIONS 	8	5x120	
HS39	SCREW FOR FUNDAMENT - SCHRAUBEN ZUR BEFESTIGUNG FUNDAMENT - VIS POUR FONDATION 	30	5x120	
HS42	SCREW FOR GABLE - SCHRAUBEN FÜR GIEBEL - VIS POUR FIXATION DES PIGNONS 	16	5x120	
HS49	SCREW FOR POST HEIGHT ADJUSTMENT - SCHRAUBEN FÜR RÉGULIERUNGSSCHRAUBE FÜR PFOSTEN - VIS DE FIXATION DE SUPPORT RÉGLABLE DE POTEAU 	32	6x50	

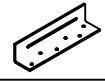
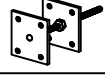
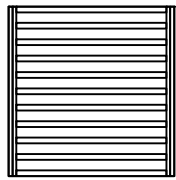
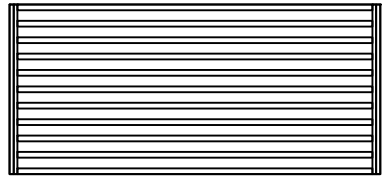
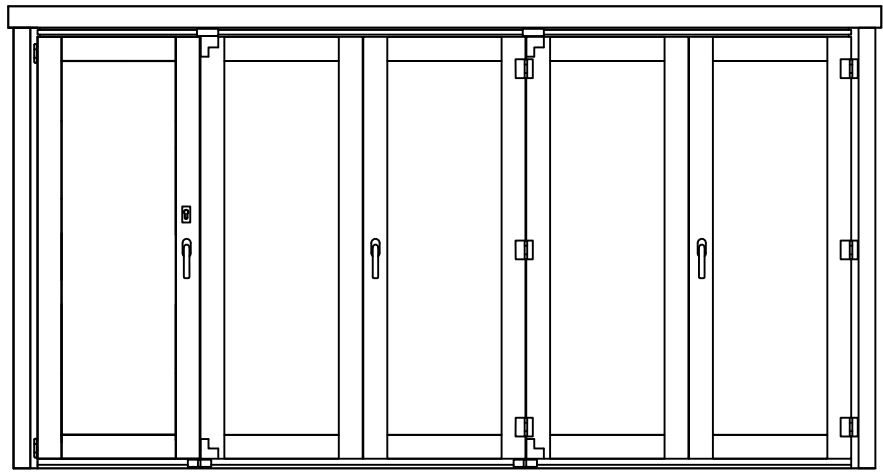
Pos	LYNDHURST 70, Art.No.7011902 Piece list - Stückliste - Liste des pieces		Q.	P (mm)	L (mm)
MS	SCREW FOR DOORSTEP - SCHRAUBEN FÜR TÜRSCHWELLE - VIS DE FIXATION DU SEUIL DE PORTE		5	4.5x65	
SH70	HAMMER BLOCK - SCHLAGHOLZ - CALLE DE FRAPPE		1		
NFD	ZN NAIL FOR ROOFING FELT FILLET - ZN NÄGEL FÜR DACHPAPPENLEISTE - POINTE POUR BAGUETTE FIXATION FEUTRE BITUMEUX		24	2x40	
NF3	ZN NAIL FOR TERRACE - ZN NÄGEL FÜR TERRASSENBRETTTER - POINTE POUR PLANCHER DE TERRASSE		330	2x50	
NFF	ZN NAIL FOR FILLETS - ZN NÄGEL FÜR LEISTEN - POINTE POUR CORNIERE		33	1.4x40	
NF2	ZN NAIL FOR ROOF - ZN NÄGEL FÜR DACHBRETTTER - POINTE POUR TOIT		564	2x50	
NH1	ZN NAIL FOR FLOOR - ZN NÄGEL FÜR FUSSBODENBRETTTER - CLOUS POUR PLANCHER		366	2x50	
ORZ	MONTAGE SET FOR DOORS AND WINDOWS - MONTAGE-SET FÜR TÜREN UND FENSTER - JEU DE MONTAGE PORTES ET FENETRES		1		
GS	GABLE SEGMENT-DECKBLATT - LOSANGE DE FINITION		2		
WLGR	SLIDING WALL TIE - SCHIEBEREGLER FÜR WAND - EQUERRE MÉTALLIQUE DE FIXATION DU PARAVENT		2		
RFP	POST HEIGHT ADJUSTMENT - REGULIERUNGSSCHRAUBE FÜR PFOSTEN - SUPPORT RÉGLABLE DE POTEAU		4		
TRR1	TERRACE RAILING - TERRASSE - GARDE-CORPS DE TERRASSE		2	824	805
TRR2	TERRACE RAILING - TERRASSE - GARDE-CORPS DE TERRASSE		2	824	1800
	DOOR-TÜR-PORTE 4100x2000		1		

