

Arkansas
Art. Nr. 703102
1/20

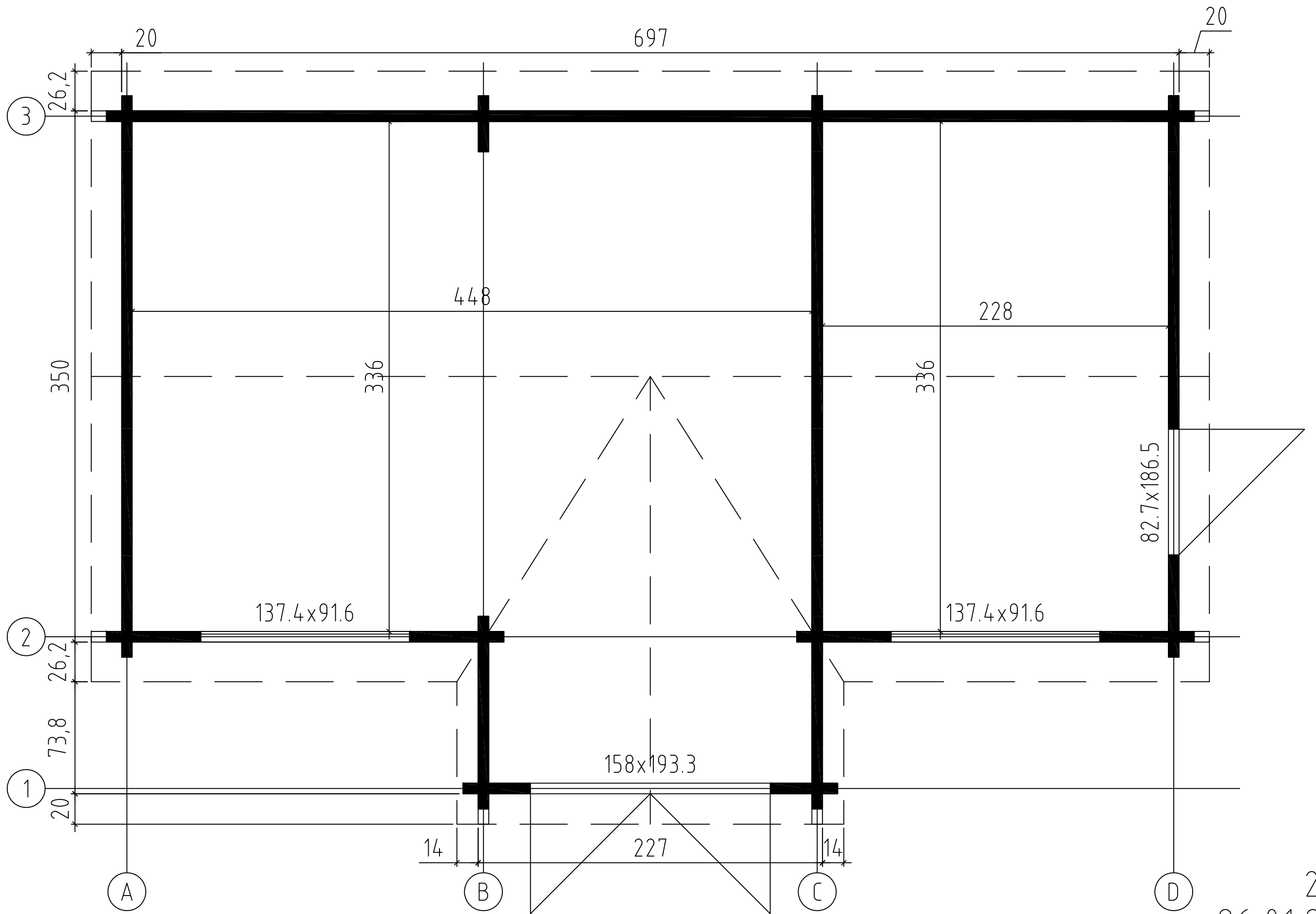

70x136
26.01.2012

GROUNDPLAN - GRUNDPLAN - PLAN DE MASSE



FOUNDATION - FUNDAMENT - FONDAZIONE

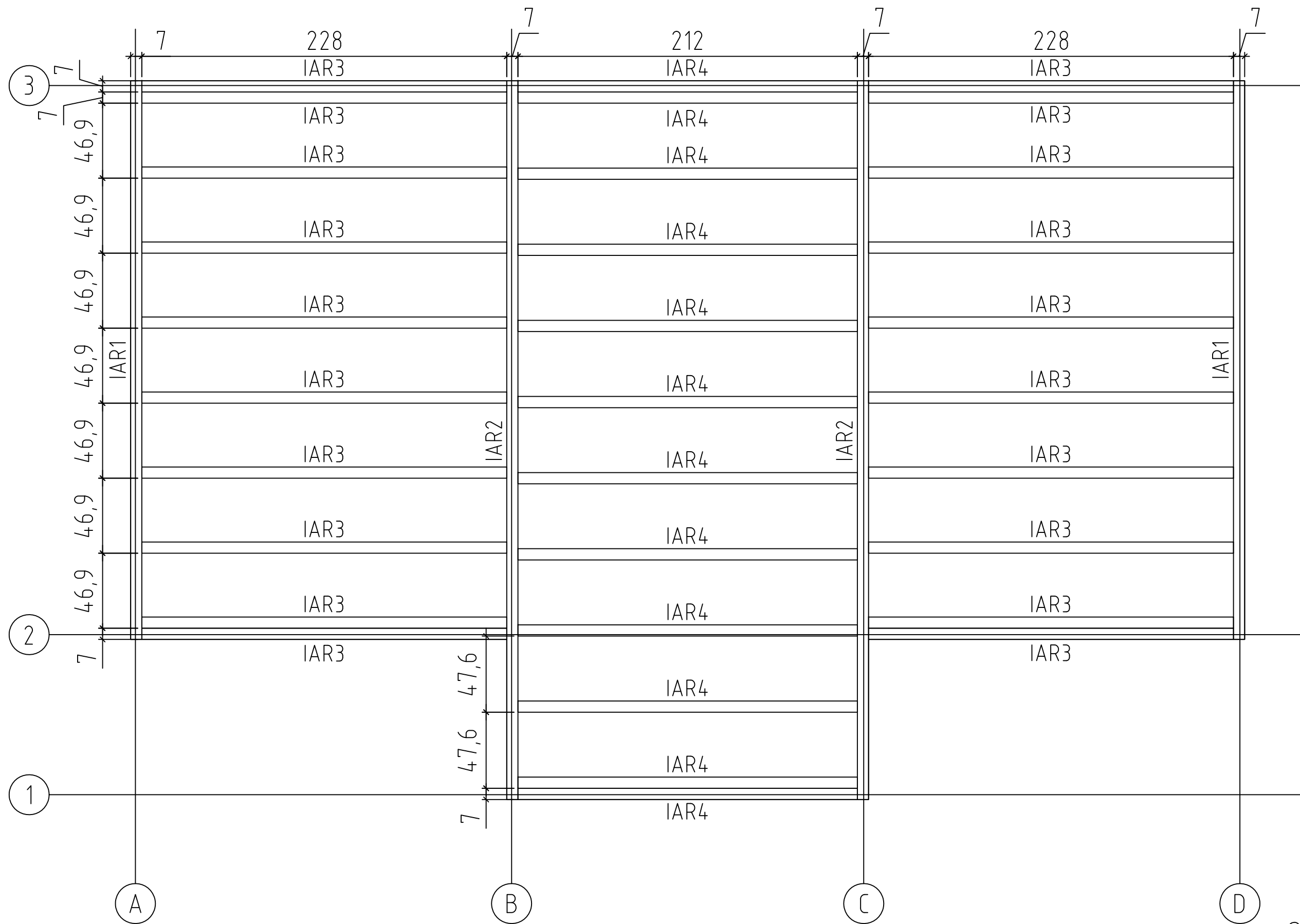

FLOOR BOARDS - FUSSBODENBRETTER - PLAN POSE PLANCHER

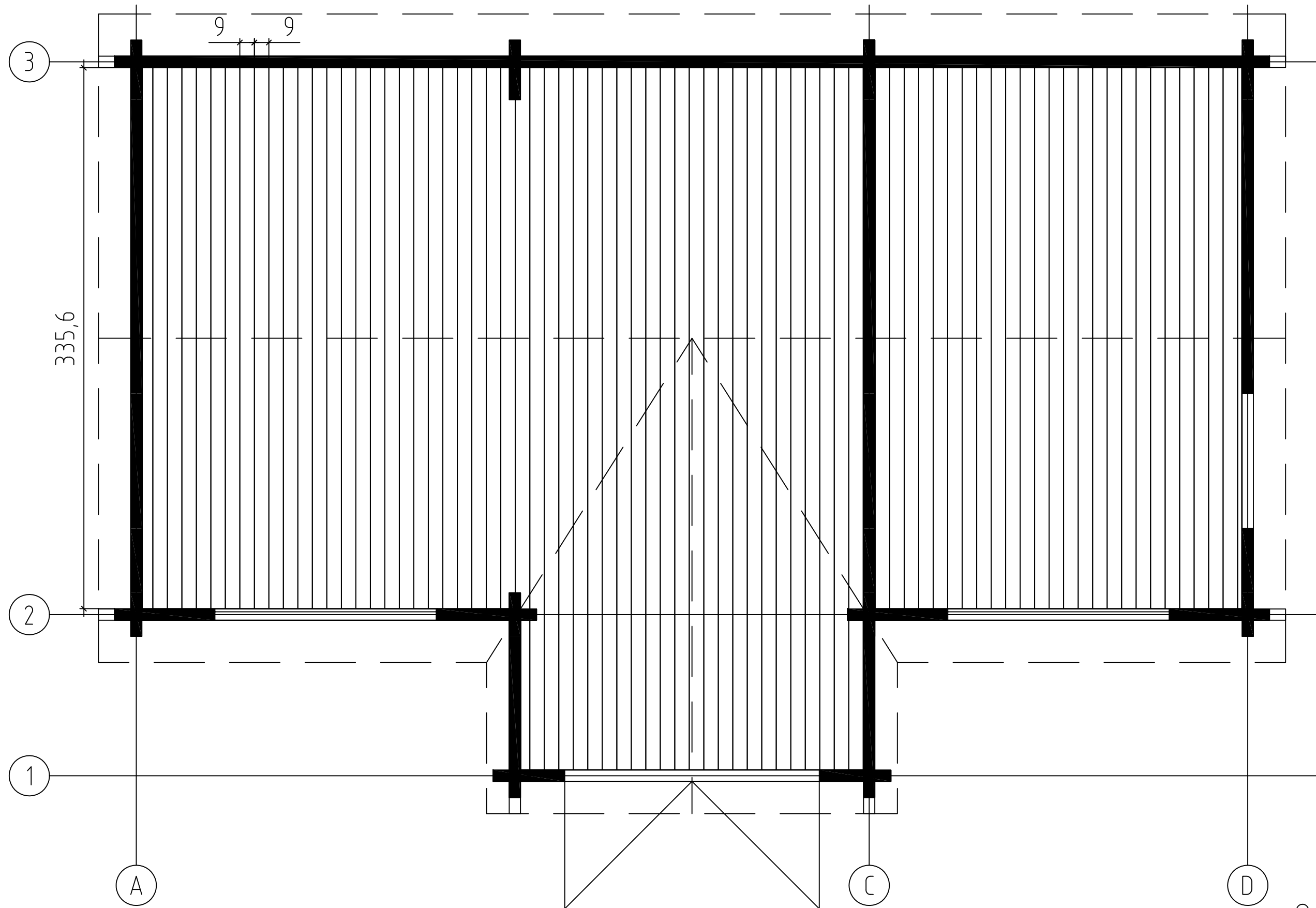

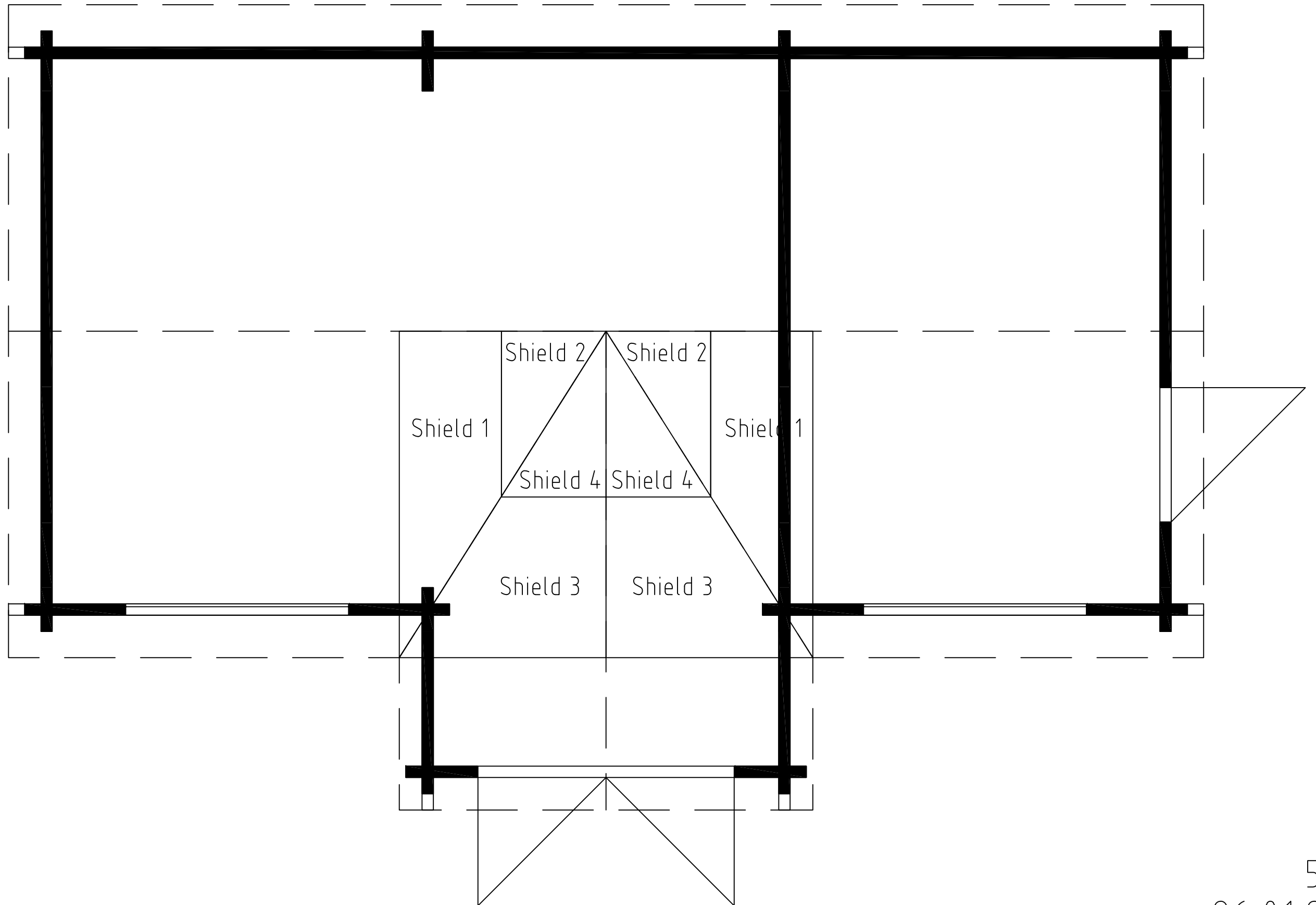

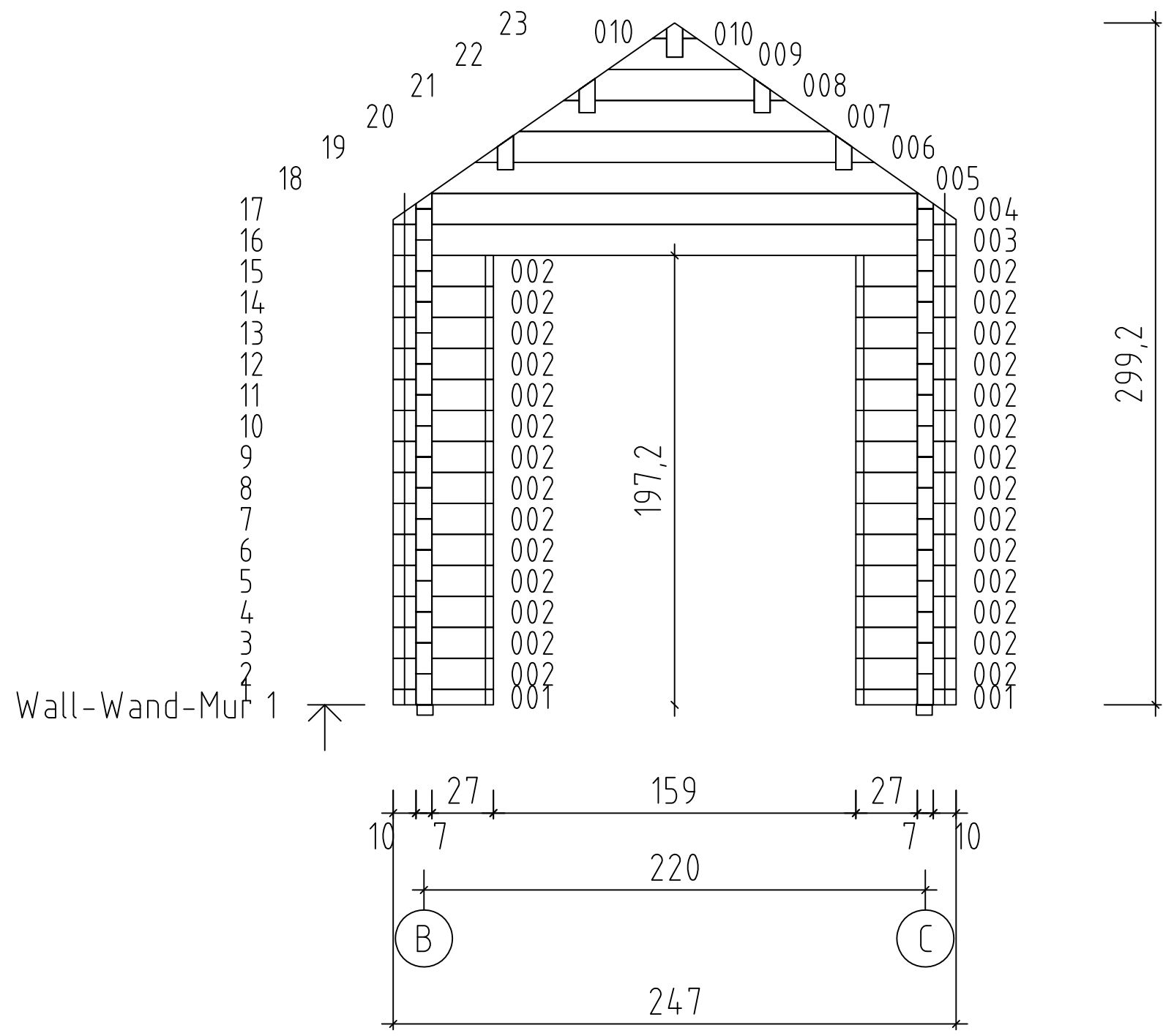

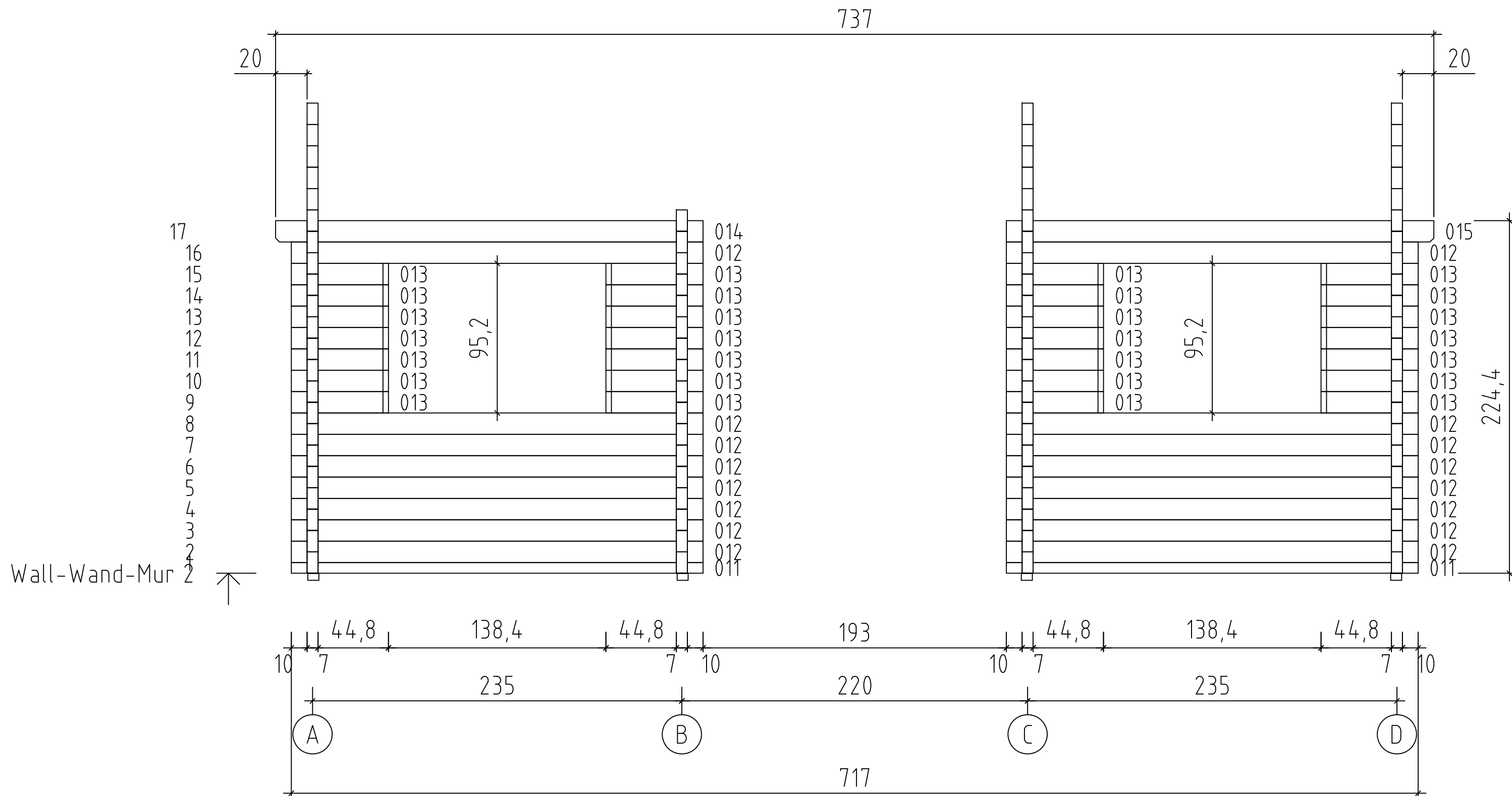

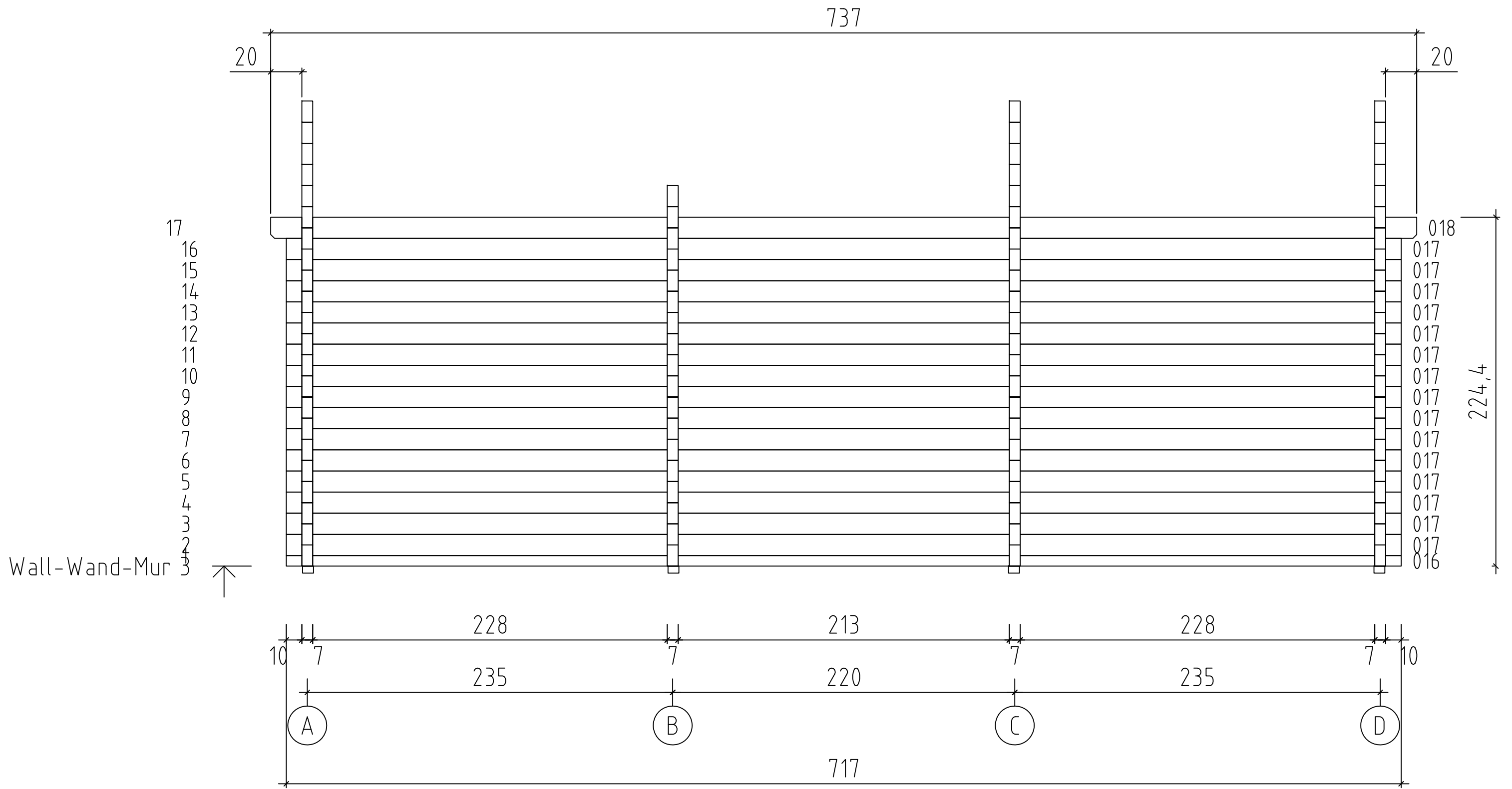

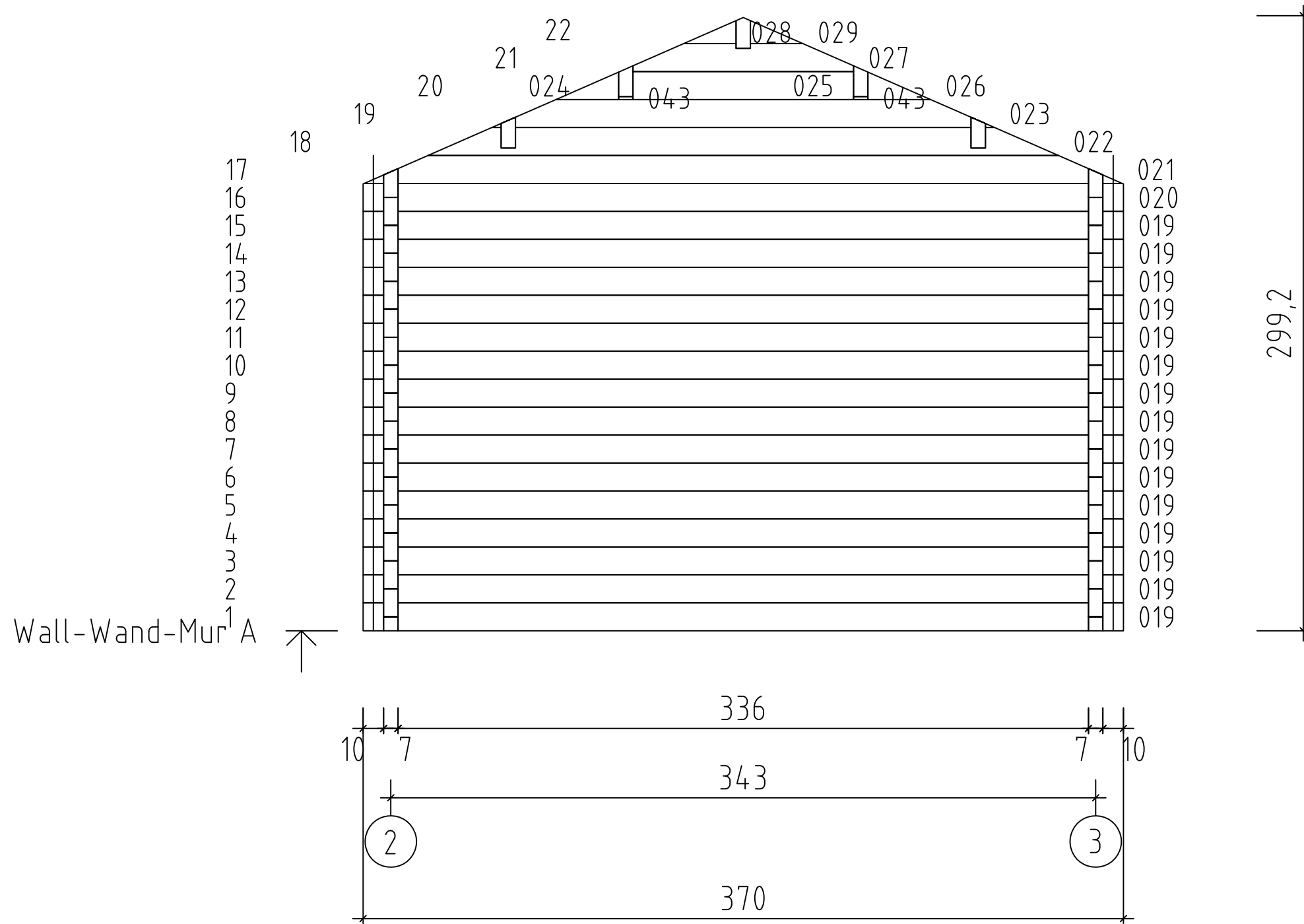

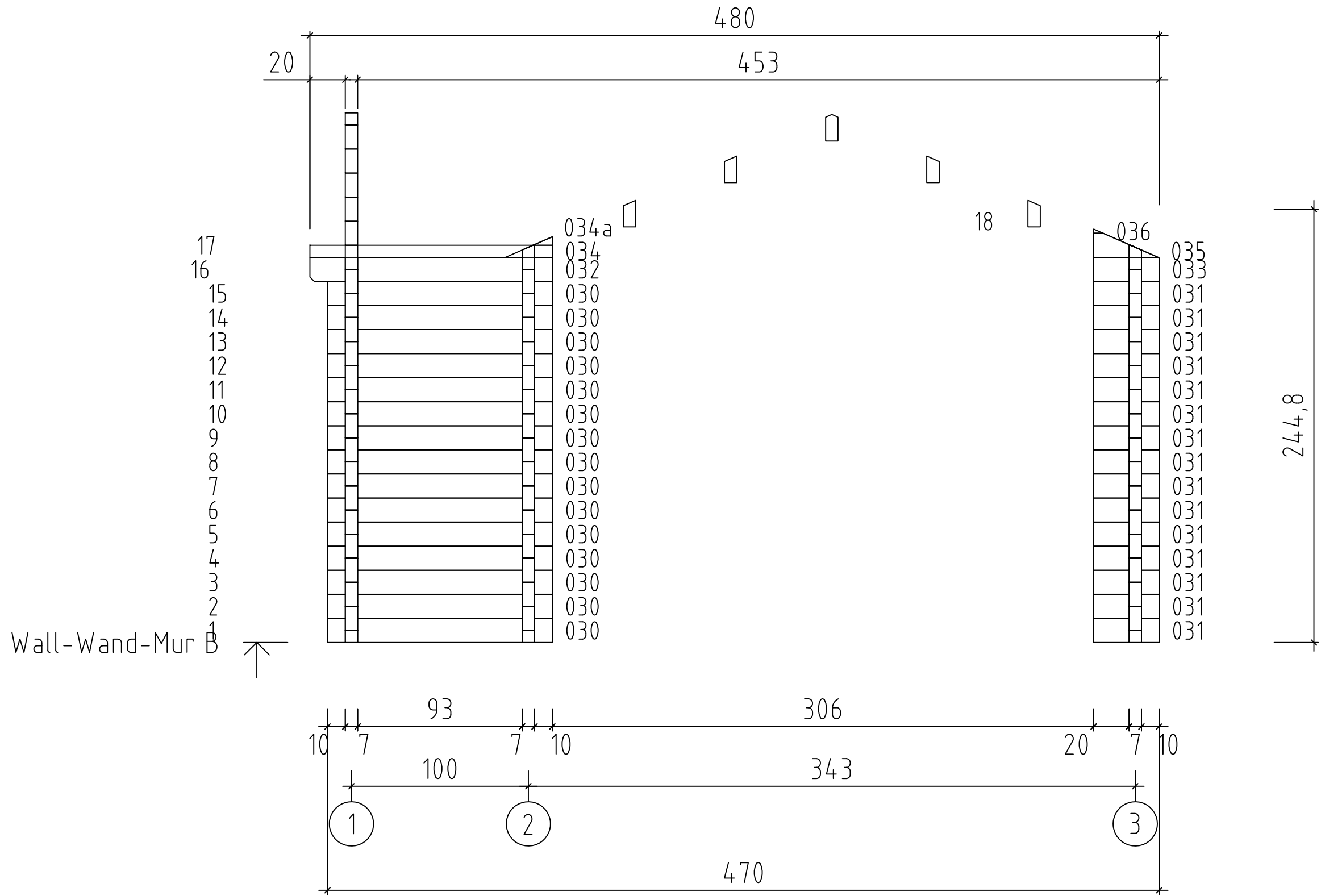

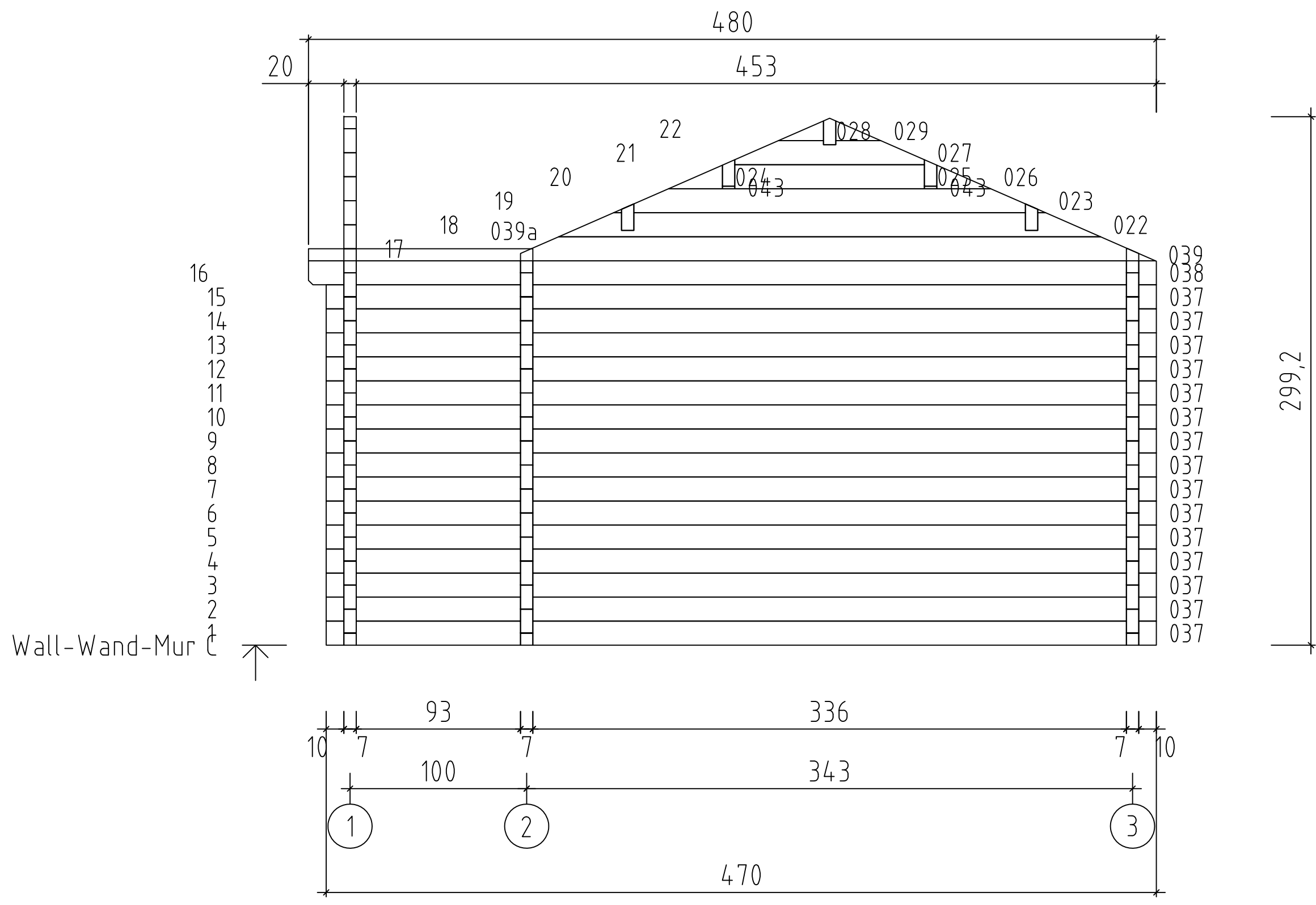

11/20
 26.01.2012
 Art. No. 703102

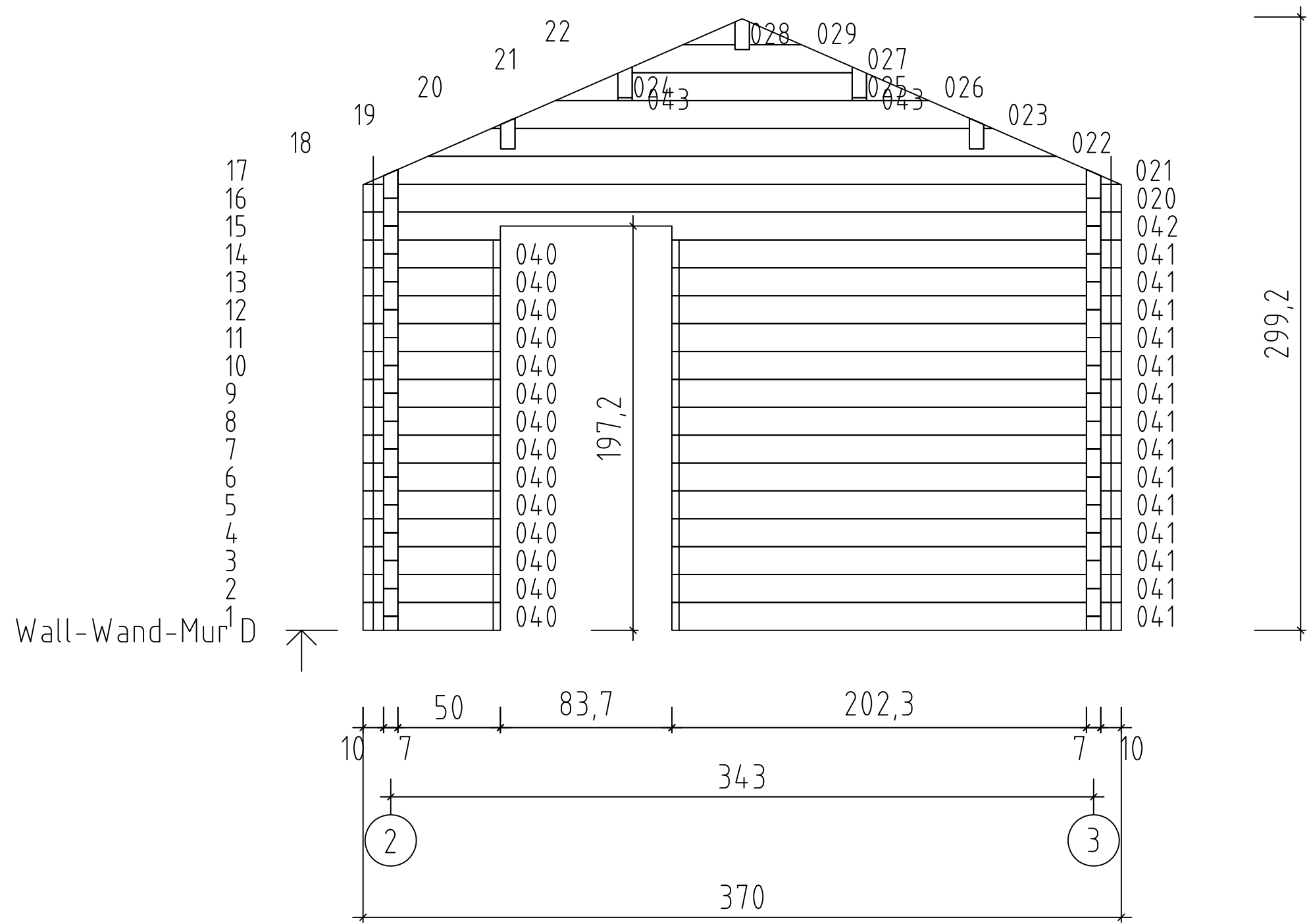

FIXING FILLET (TBE6) FOR WINDOW AND DOOR - FIXIRUNGSLEISTE (TBE6) FÜR FENSTER UND TÜR
PROFIL DE FIXATION DES FENÊTRES ET PORTES (TBE6)

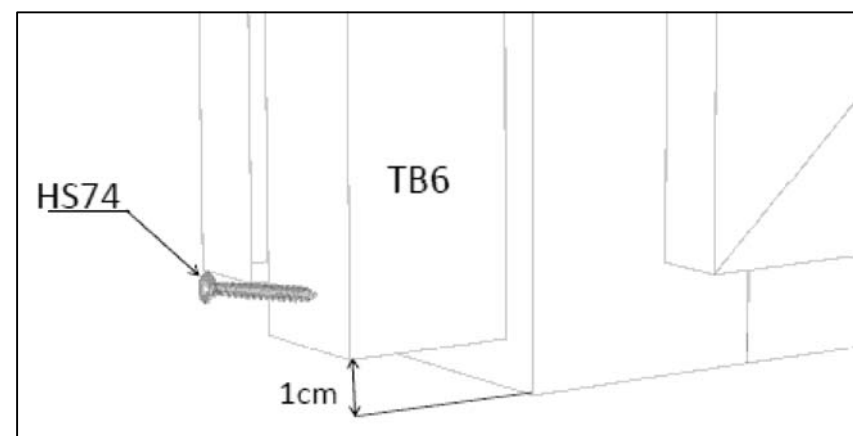
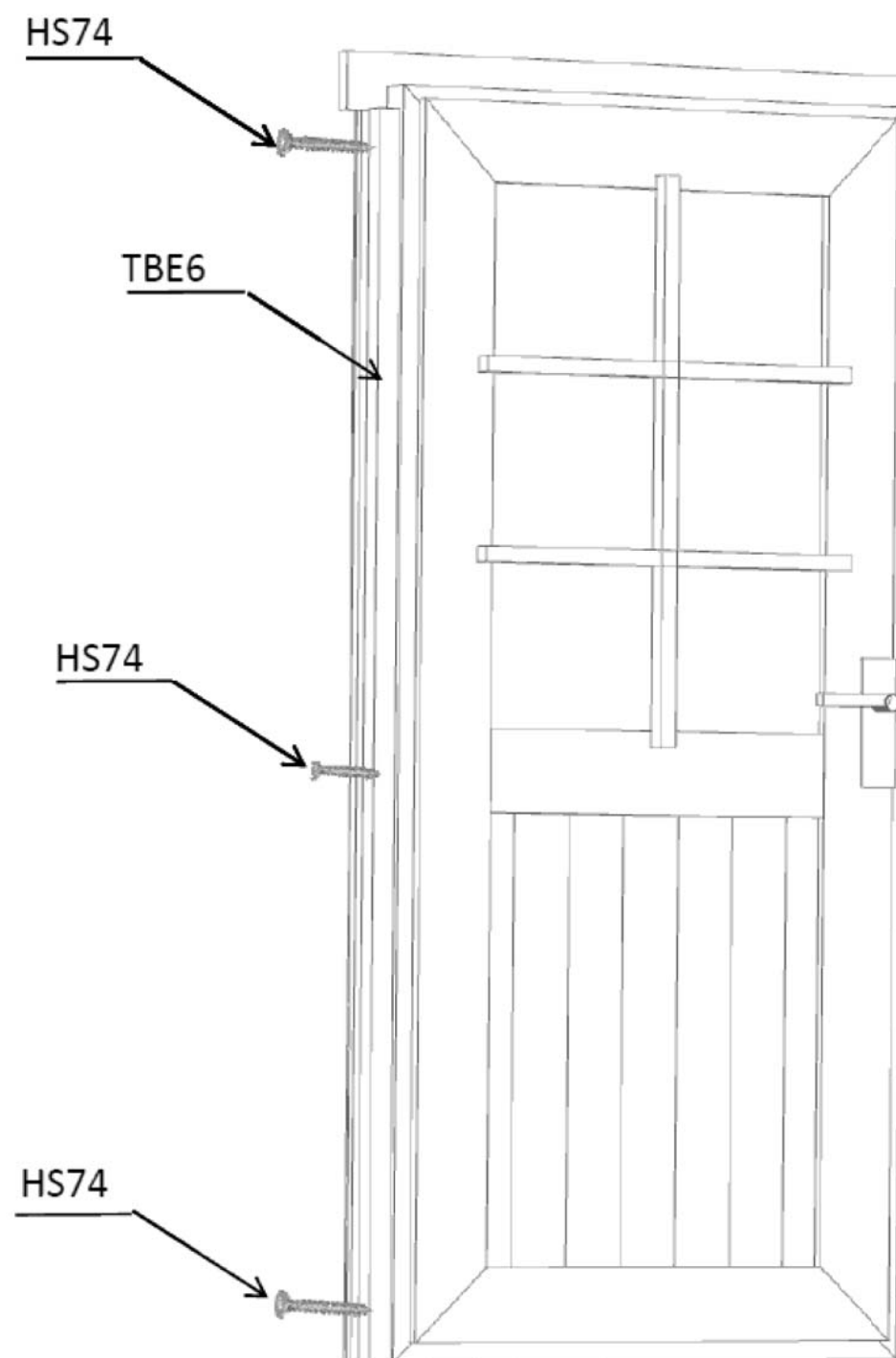
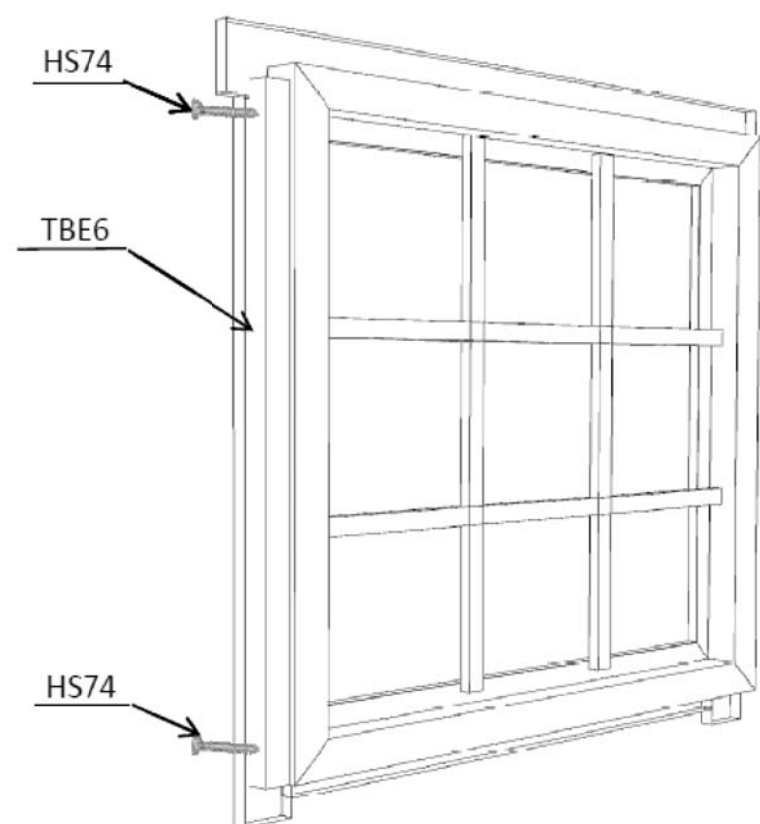

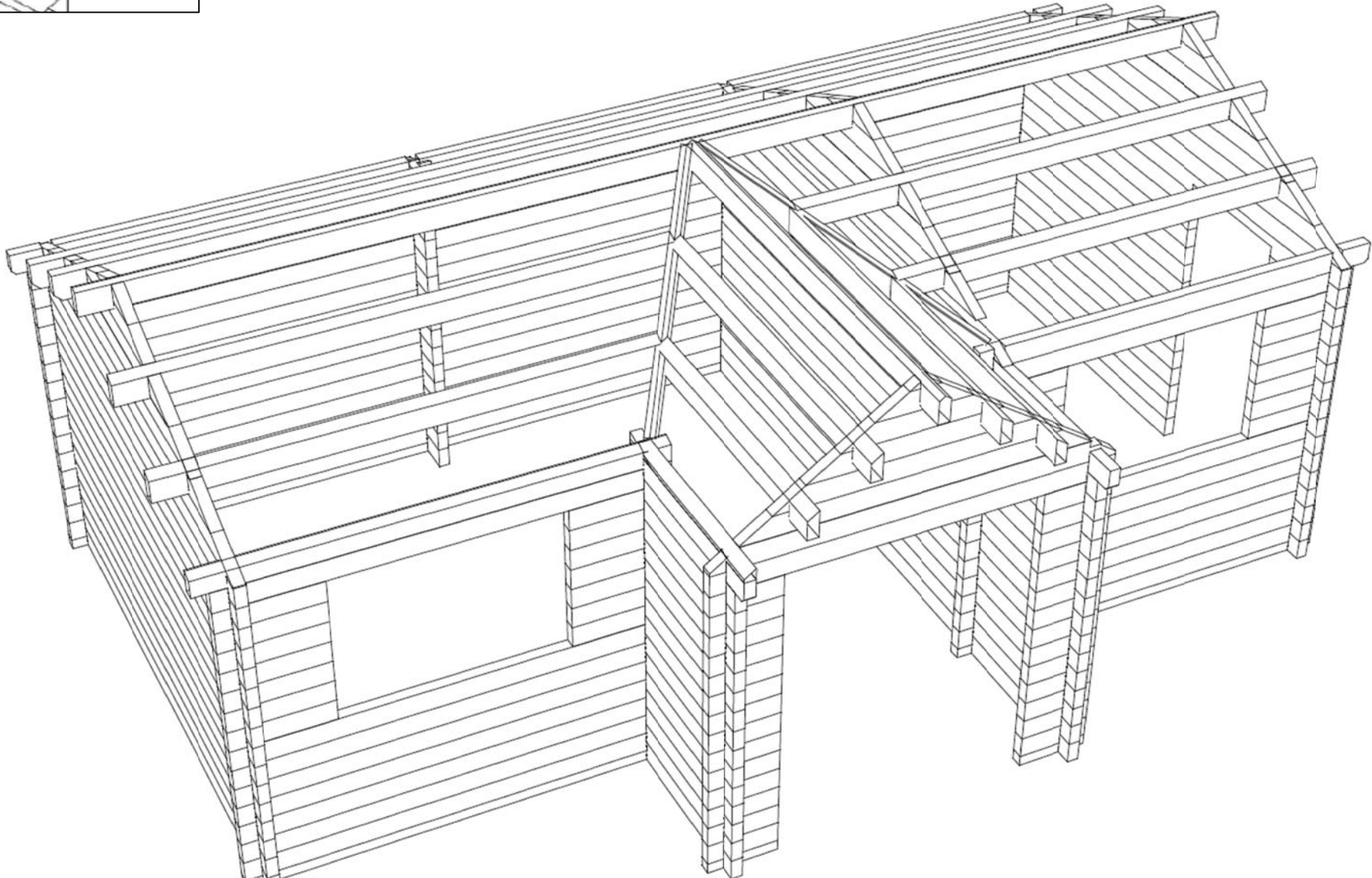
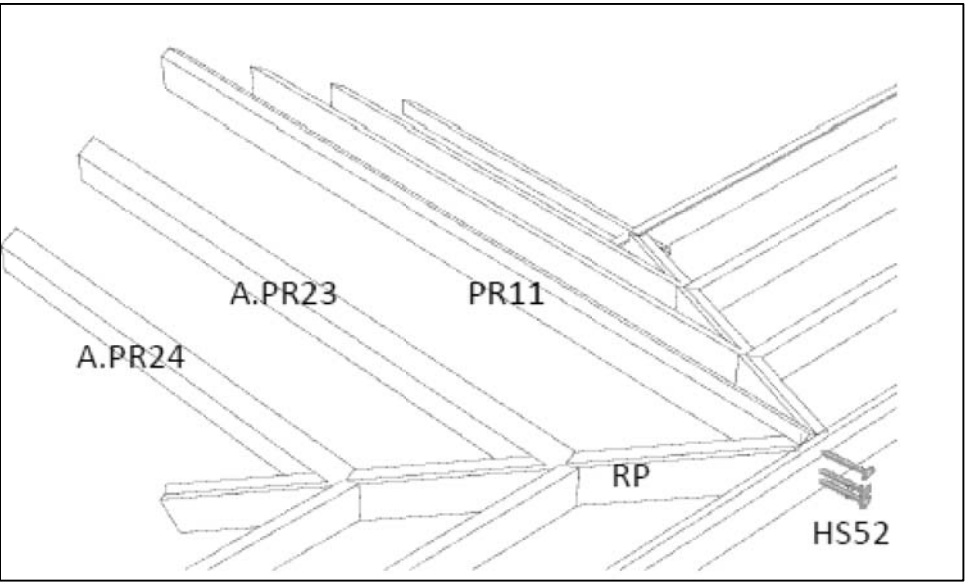
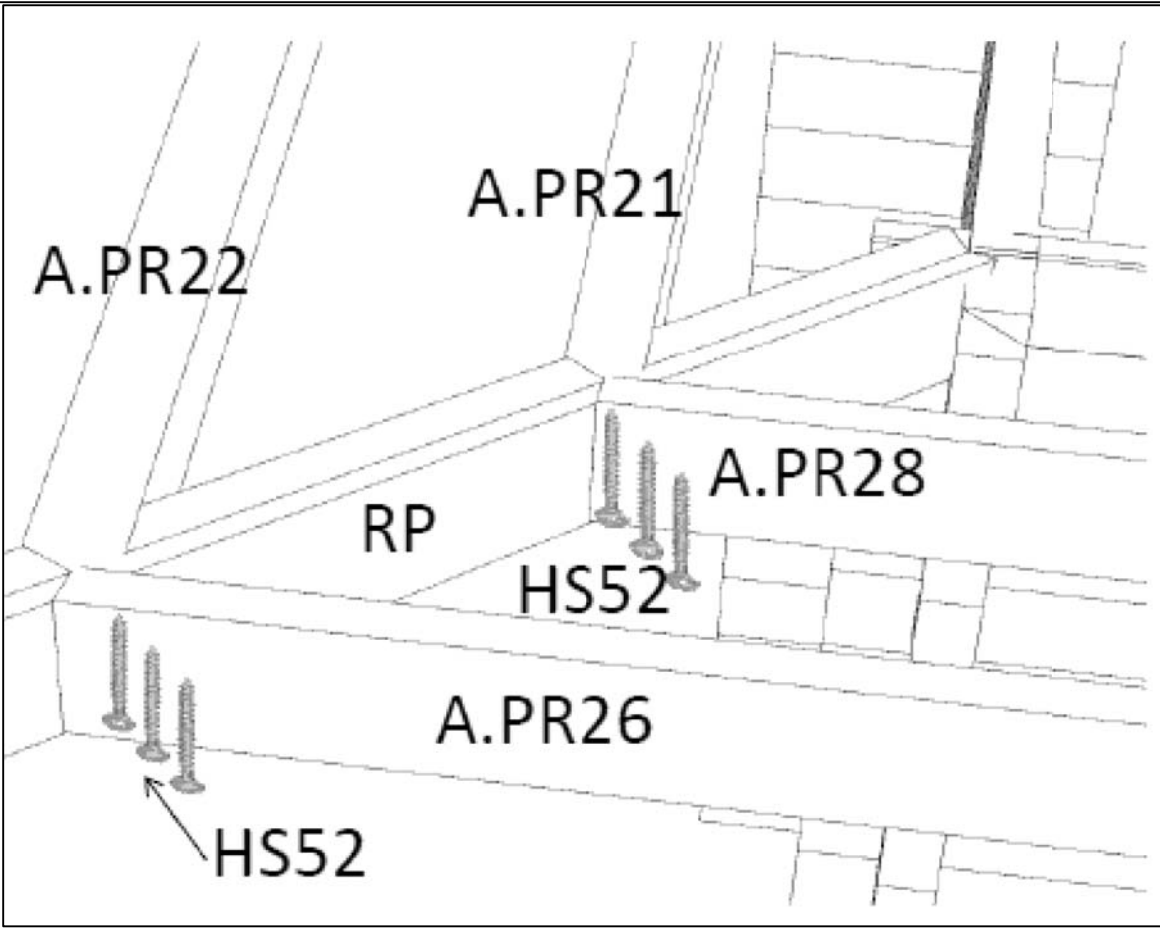
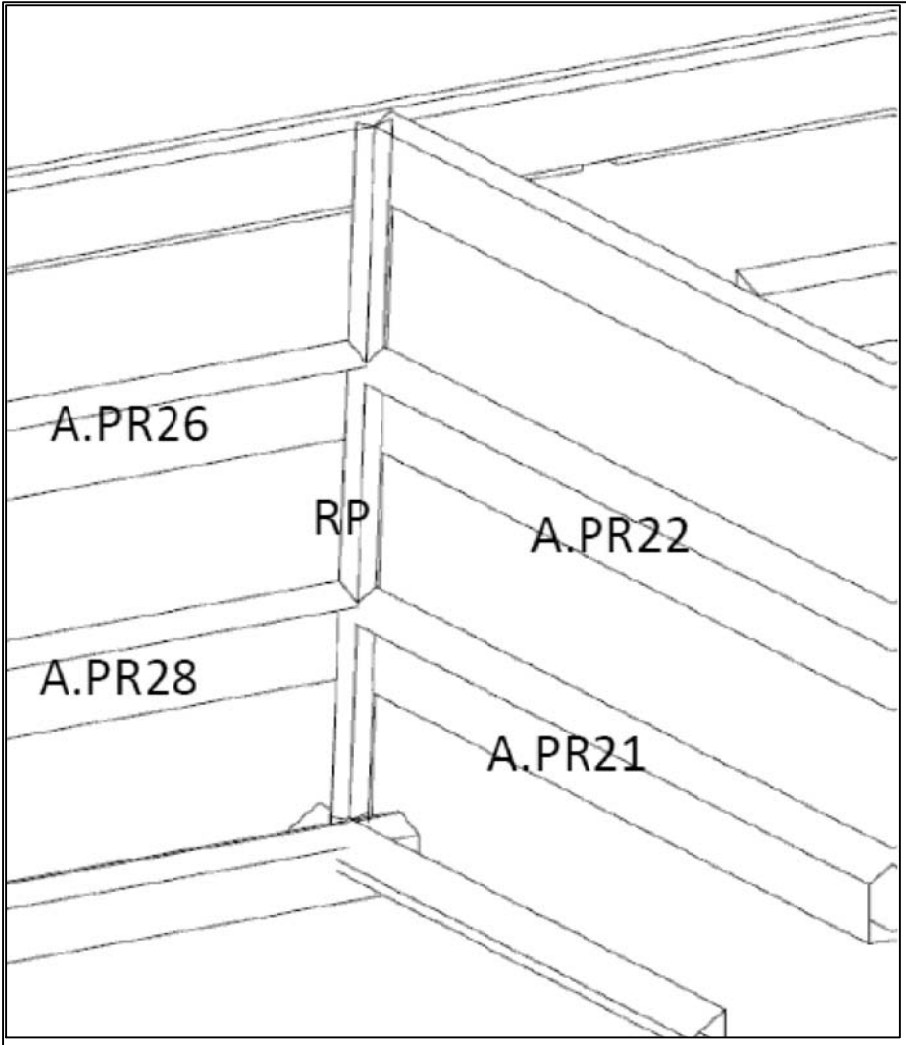

Pos	26.01.2012	Arkansas Art. No. 703102	15/20	Q.	P (mm)	L (mm)
001				2	70x68	440
002				28	70x136	440
003				1	70x136	2470
011				2	70x68	2620
012				16	70x136	2620
013				28	70x136	618
014				1	70x136	2720
015				1	70x136	2720
016				1	70x68	7170
017				15	70x136	7170
018				1	70x136	7370
019				15	70x136	3700
030				15	70x136	1270
031				15	70x136	370
034 034a		034a 		1	70x68	1370
036 035				1	70x136	365
037				15	70x136	4700
038				1	70x136	4700
039a				1	70x68	1261
040				14	70x136	670
041				14	70x136	2193
042				1	70x136	3700
W1-1				1		
WA-1				1		

Pos	26.01.2012	Arkansas Art. No. 703102	16/20	Q.	P (mm)	L (mm)
WC-2				1		
WD-1				1		
IAR2	FOUNDATION - FUNDAMENT - FONDATION 			2	70x45	4490
IAR1	FOUNDATION - FUNDAMENT - FONDATION 			2	70x45	3490
IAR3	FOUNDATION - FUNDAMENT - FONDATION 			20	70x45	2280
IAR4	FOUNDATION - FUNDAMENT - FONDATION 			12	70x45	2120
PR12	ROOF BEAM - DACHBALKEN - PANNE DE TOIT 			1	70x170	7370
PR11	ROOF BEAM - DACHBALKEN - PANNE DE TOIT 			1	70x170	2915
A.PR25	ROOF BEAM - DACHBALKEN - PANNE DE TOIT 			2	70x170	7370
A.PR27	ROOF BEAM - DACHBALKEN - PANNE DE TOIT 			1	70x170	3298
A.PR26	ROOF BEAM - DACHBALKEN - PANNE DE TOIT 			1	70x170	3298
A.PR29	ROOF BEAM - DACHBALKEN - PANNE DE TOIT 			1	70x170	2940
A.PR28	ROOF BEAM - DACHBALKEN - PANNE DE TOIT 			1	70x170	2940
A.PR23	ROOF BEAM - DACHBALKEN - PANNE DE TOIT 			1	70x170	2353
A.PR22	ROOF BEAM - DACHBALKEN - PANNE DE TOIT 			1	70x170	2353
A.PR24	ROOF BEAM - DACHBALKEN - PANNE DE TOIT 			1	70x170	1781
A.PR21	ROOF BEAM - DACHBALKEN - PANNE DE TOIT 			1	70x170	1781
RP	RAFTER - DACHSPARREN - CHEVRON 			1	63x170	2133
RP	RAFTER - DACHSPARREN - CHEVRON 			1	63x170	2133
FB	FLOOR BOARDS - FUSSBODENBRETTER - LAME DE PLANCHER 			24	90x18	4356
FB	FLOOR BOARDS - FUSSBODENBRETTER - LAME DE PLANCHER 			52	90x18	3356
DB	ROOF BOARDS - DACHBRETTER - VOLIGES 			136	90x18	2200
DB	ROOF BOARDS - DACHBRETTER - VOLIGES 			22	90x18	1555

ROOF BOARDS - DACHBRETTER - VOLIGES

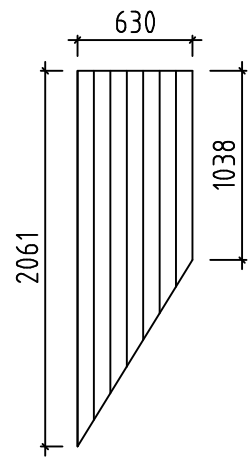

Shield 1 / 2tk

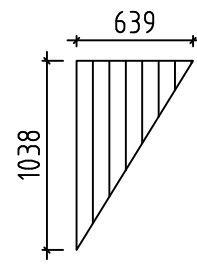





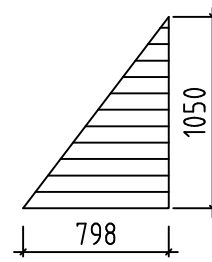
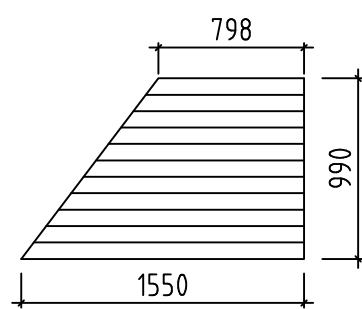





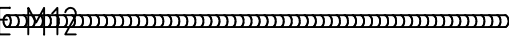
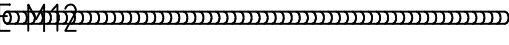
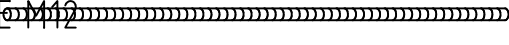
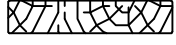







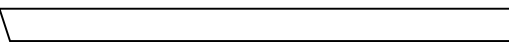
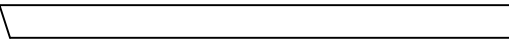
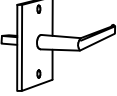

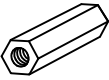

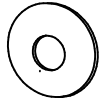





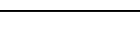
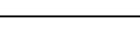
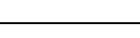

Shield 2 / 2tk

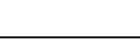
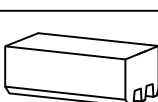
Shield 3 / 2tk



Shield 4 / 2tk

Pos	26.01.2012	Arkansas Art. No. 703102	18/20	Q.	P (mm)	L (mm)
FL	FLOOR FILLET-FUSSBODENLEISTE - CORNIERE DE FINITION DU PLANCHER				18x18	28.93
DPL	ROOFING FELT FILLET - DACHPAPPENLEISTE - BAGUETTE DE FIXATION DU FEUTRE BITUMEUX		2		18x58	1605
DPL	ROOFING FELT FILLET - DACHPAPPENLEISTE - BAGUETTE DE FIXATION DU FEUTRE BITUMEUX		4		18x58	2250
M12	TREADED ROD M12 - GEWINDESTANGE M12 - TIGE FILETÉE M12		2			200
M12	TREADED ROD M12 - GEWINDESTANGE M12 - TIGE FILETÉE M12		4			250
M12	TREADED ROD M12 - GEWINDESTANGE M12 - TIGE FILETÉE M12		6			2000
TB	EAVES BOARD - TRAUFBRETT - BANDEAU DE TOIT		2		18x90	934
TB	EAVES BOARD - TRAUFBRETT - BANDEAU DE TOIT		2		18x90	2412
TB	EAVES BOARD - TRAUFBRETT - BANDEAU DE TOIT		2		18x90	3685
DRV	ROOF EDGE REINFORCEMENT - DACHRANDVERSTÄRKUNG - CORNIERE DE RENFORT DE BORD DE TOIT		2		28x34	934
DRV	ROOF EDGE REINFORCEMENT - DACHRANDVERSTÄRKUNG - CORNIERE DE RENFORT DE BORD DE TOIT		2		28x34	2412
DRV	ROOF EDGE REINFORCEMENT - DACHRANDVERSTÄRKUNG - CORNIERE DE RENFORT DE BORD DE TOIT		2		28x34	3685
TBE6	FIXING FILLET - FIXIRUNGSLEISTE - PROFIL DE FIXATION		4		28x34	940
TBE6	FIXING FILLET - FIXIRUNGSLEISTE - PROFIL DE FIXATION		4		28x34	1900
GL	GABLE MOULDING - GIEBELLEISTE - PLANCHE DE RIVE		2		18x120	1605
GL	GABLE MOULDING - GIEBELLEISTE - PLANCHE DE RIVE		4		18x120	2250
FS	WINDOW HANDLE FITTINGS-FENSTERGRIFF - POIGNÉE D'OUVERTURE DE FENETRE		2			

Pos	26.01.2012	Arkansas Art. No. 703102	19/20	Q.	P (mm)	L (mm)
KL4	LENGTHENING BOLT FOR TREADED ROD - VERLÄNGERUNGSMUTTER FÜR GEWINDESTANGE - MANCHON DE RACCORDEMENT DE TIGE FILETÉE			6		
KL1	DRIVE NUT TREADED ROD - EINSHLAGMUTTER FÜR GEWINDESTANGE - ÉCROU A FRAPPER POUR TIGE FILITÉE			6		
KL2	NUT FOR TREADED ROD - MUTTER FÜR GEWINDESTANGE - ÉCROU POUR TIGE FILETÉE			6		
KL3	PLAIN WASHER TREADED ROD - UNTERLEGSCHIEBE FÜR GEWINDESTANGE - RONDELLE PLATE POUR TIGE FILETÉE			6		
HS12	SCREW FOR GABLE SEGMENT - SCHRAUBEN FÜR DECKBLATT - VIS POUR FIXATION LOSANGE DE FINITION			6	3.5x35	
HS16	SCREW FOR GABLE MOULDING - SCHRAUBEN FÜR GIEBELLEISTE - VIS DE FIXATION POUR PLANCHE DE RIVE			48	3.5x50	
HS3	SCREW FOR DOOR FILLET - SCHRAUBE ZUR BEFESTIGUNG TÜRLEISTE - VIS D'ASSEMBLAGE DU CADRE DE PORTE			5	3x30	
HS32	SCREW FOR EAVES BOARDS - SCHRAUBEN FÜR TRAUFBRETTER - VIS DE FIXATION POUR BANDEAU DE TOIT			40	4x40	
HS26	SCREW FOR ROOF EDGE REINFORCEMENT - SCHRAUBEN FÜR DACHRANDVERSTÄRKUNG - VIS POUR RENFORT DE BORD DE TOIT			40	4x40	
HS57	SCREW FOR FIXING FILLET OF DOOR AND WINDOWS - SCHRAUBEN FÜR FIXIRUNGSLEISTE - VIS POUR PROFIL DE FIXATION DES PORTES/FENETRE			32	4x50	
HS39	SCREW FOR FUNDAMENT - SCHRAUBEN ZUR BEFESTIGUNG FUNDAMENT - VIS POUR FONDATION			76	5x120	
HS52	SCREW FOR ROOF BEAMS - SCHRAUBEN FÜR DACHBALKEN - VIS POUR PANNE DE TOIT			39	5x120	
HS43	SCREW FOR ROOF BEAMS - SCHRAUBEN FÜR DACHBALKEN - VIS POUR PANNE DE TOIT			28	5x120	
HS42	SCREW FOR GABLE - SCHRAUBEN FÜR GIEBEL - VIS POUR FIXATION DES PIGNONS			56	5x120	
HS40	SCREW FOR 1. WALL BEAM - SCHRAUBE FÜR 1. BOHLENREIHE - VIS DE FIXATION DES FONDATIONS			17	5x90	
HS41	SCREW FOR DOOR JAMB - SCHRAUBE FÜR TÜRRAHMEN - VIS DE FIXATION POUR MONTANT DE PORTE			4	5x90	
NFF	ZN NAIL FOR FLOOR FILLET - ZN NÄGEL FÜR FUSSBODENLEISTE - POINTE POUR CORNIERE DE FINITION DU PLANCHER			60	1.4x40	
SH70	HAMMER BLOCK - SCHLAGHOLZ - CALLE DE FRAPPE			1		
MS	SCREW FOR DOORSTEP - SCHRAUBEN FÜR TÜRSCHWELLE - VIS DE FIXATION DU SEUIL DE PORTE			5	4.5x65	
NFD	ZN NAIL FOR ROOFING FELT FILLET - ZN NÄGEL FÜR DACHPAPPENLEISTE - POINTE POUR BAGUETTE FIXATION FEUTRE BITUMEUX			25	2x40	
GS	GABLE SEGMENT-DECKBLATT - LOSANGE DE FINITION			3		
NF2	ZN NAIL FOR ROOF - ZN NÄGEL FÜR DACHBRETT - POINTE POUR TOIT			876	2.1x50	
NH1	ZN NAIL FOR FLOOR - ZN NÄGEL FÜR FUSSBODENBRETT - CLOUS POUR PLANCHER			674	2x50	
TS3	DOOR HANDLE FITTINGS-TÜRGRIF - SET DE GARNITURES DE SERRURE DE PORTE			2		
TS4	SET OF DOOR LOCK COVERS - SCHLOSSBLENDEN - SET DE GARNITURES DE SERRURE DE PORTE			2		

