

*DORSET 71*  
*Art.No. 709502*

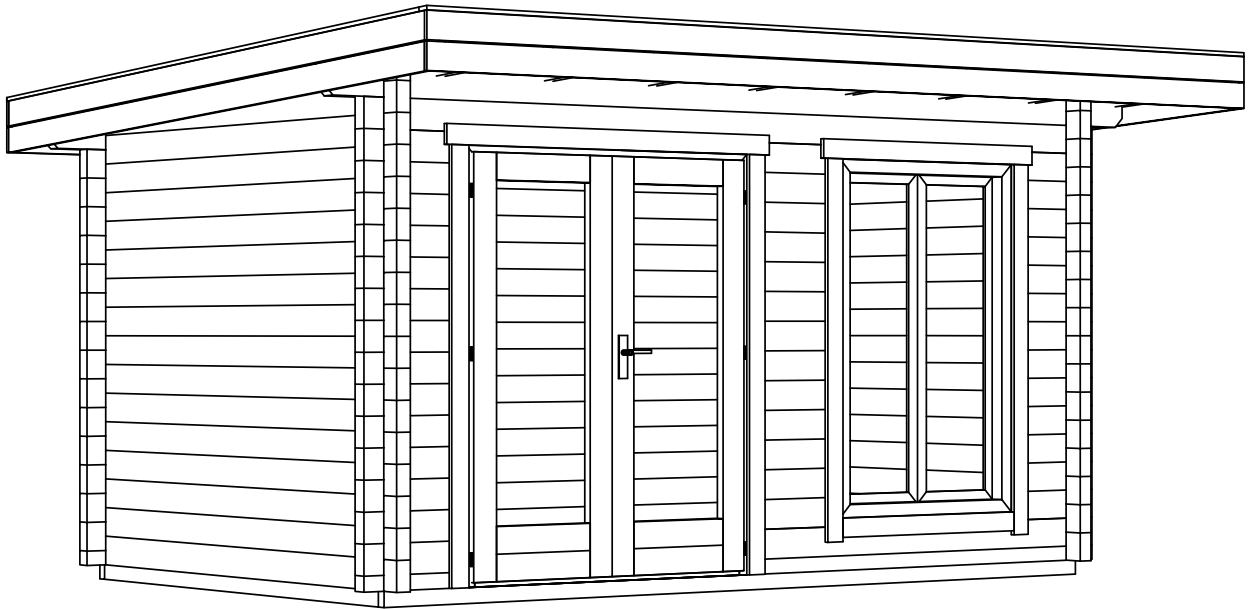

DORSET 71, Art.No.709502  
GROUNDPLAN - GRUNDPLAN - PLAN DE MASSE

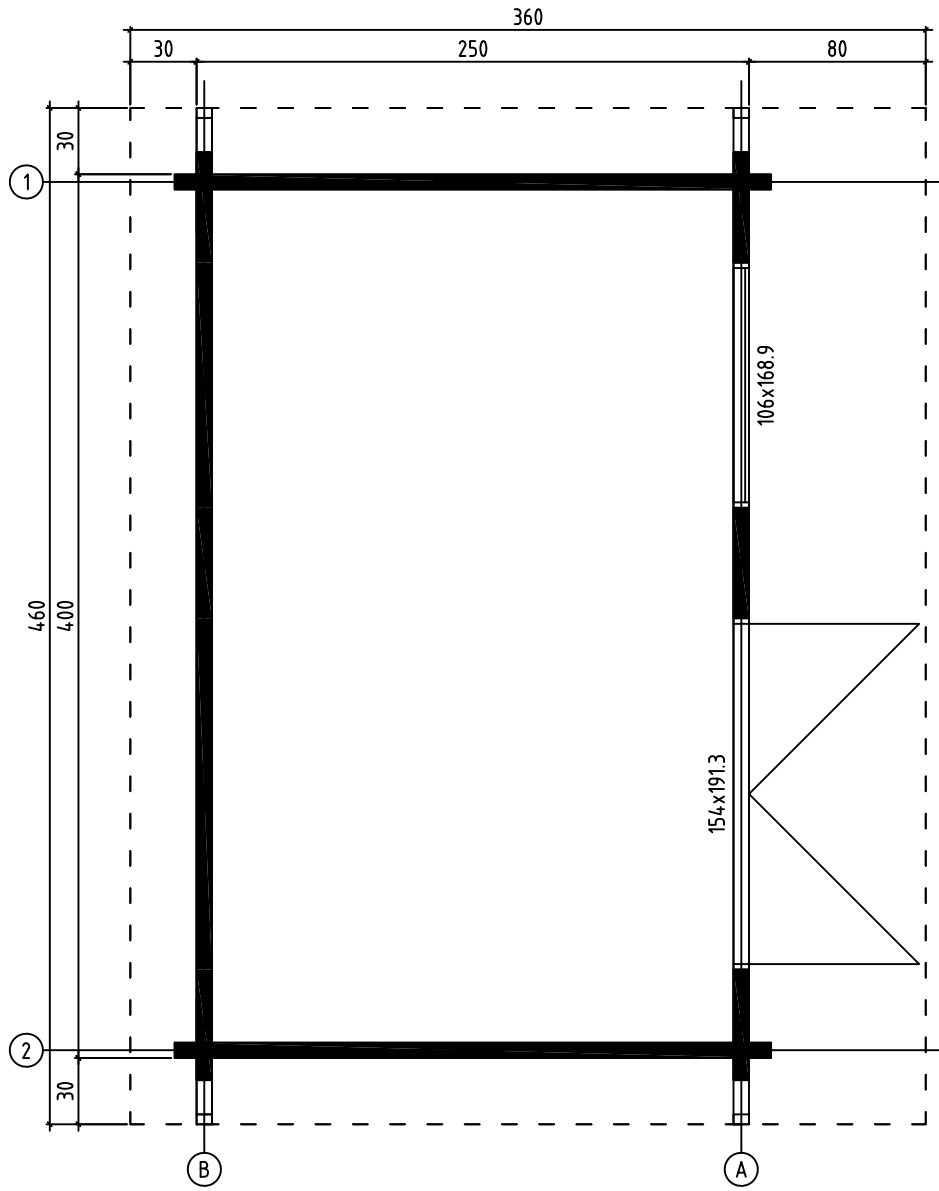

DORSET 71, Art.No.709502  
FOUNDATION - FUNDAMENT - FONDATION

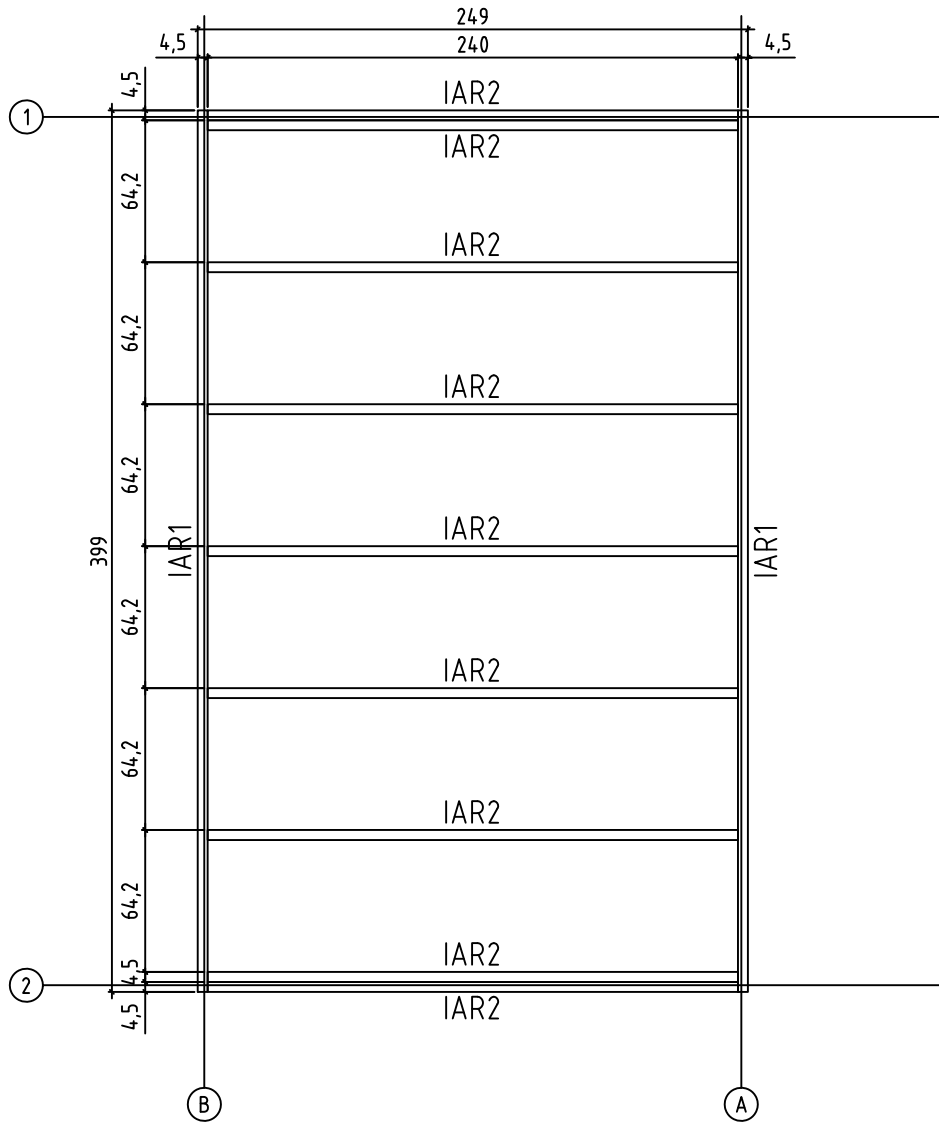

DORSET 71, Art.No.709502  
RAFTERS PLAN - DACHSPARREN - PLAN DE CHEVRON

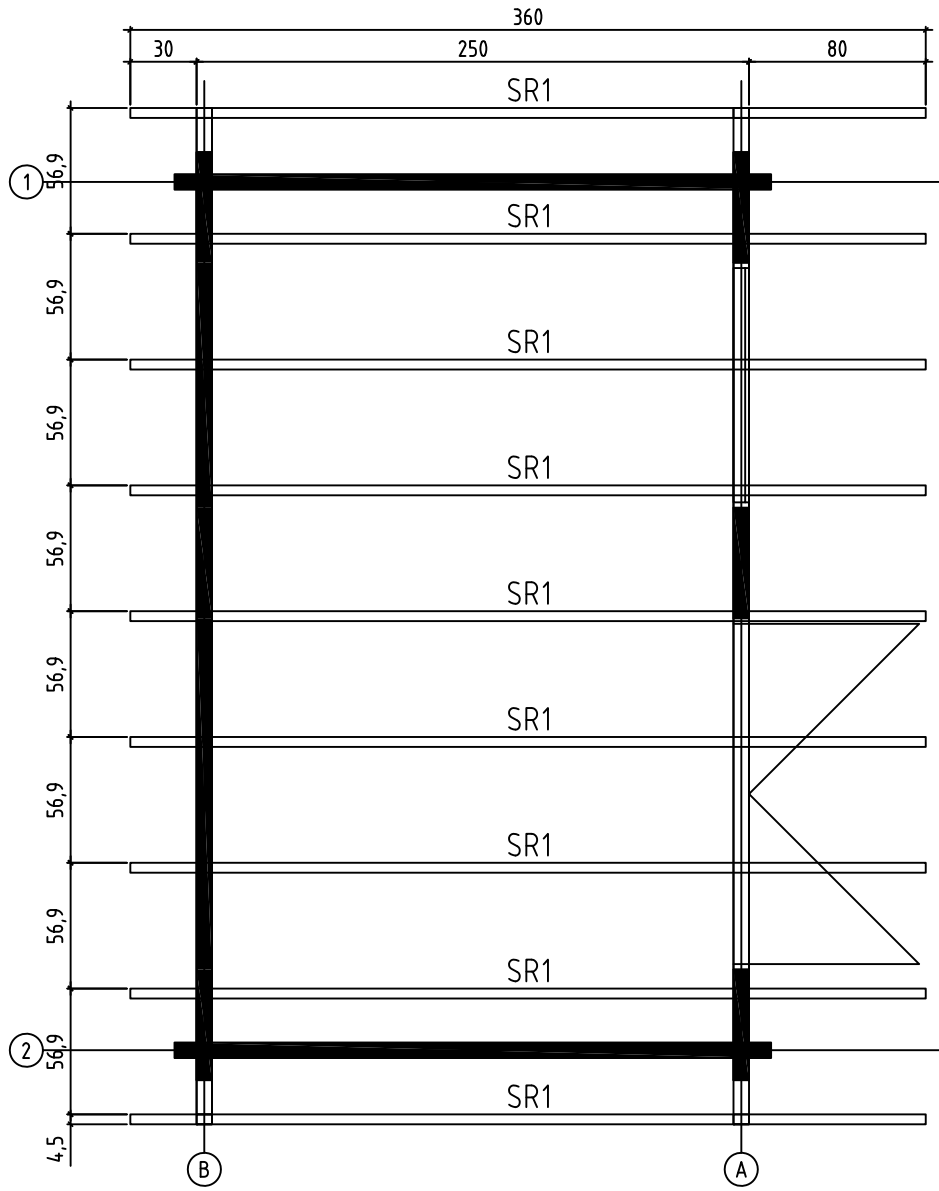

DORSET 71, Art.No.709502  
FLOOR BOARDS - FUSSBODENBRETTER - PLAN POSE PLANCHER

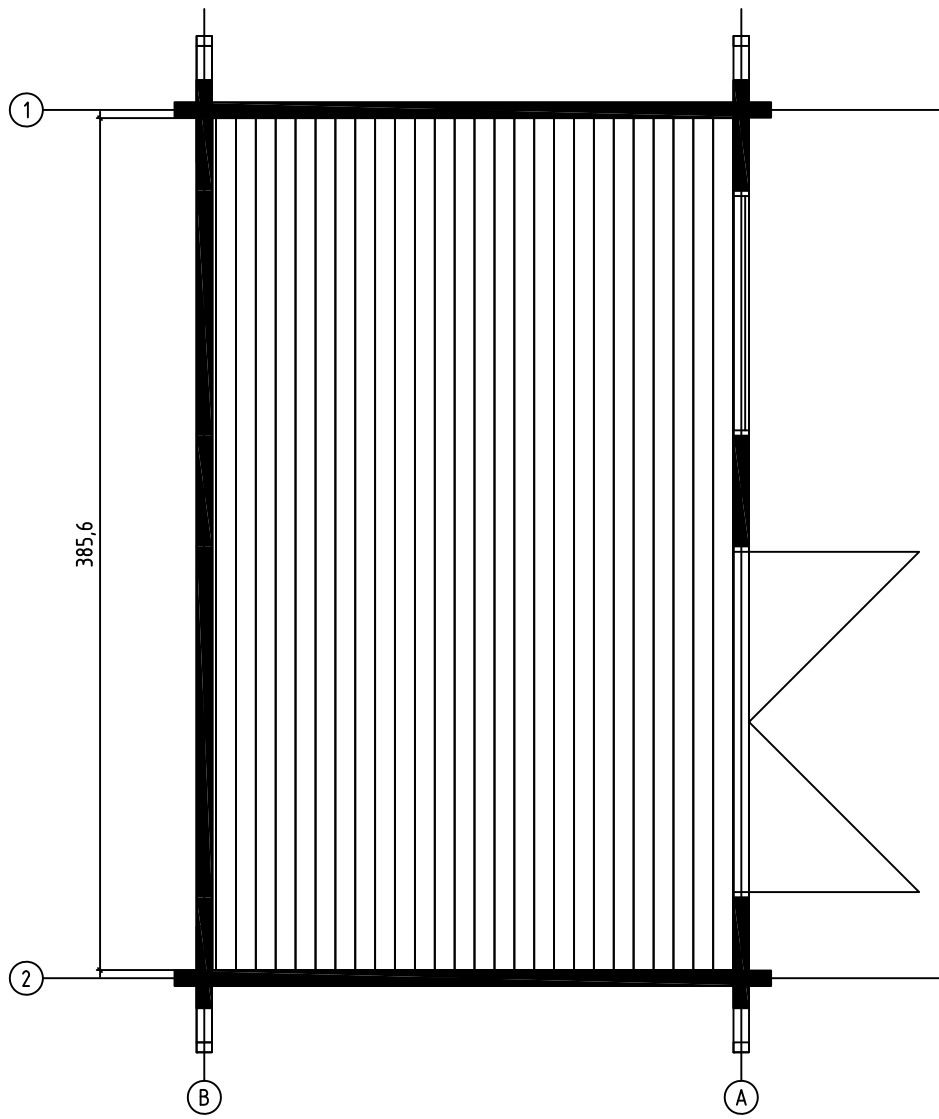

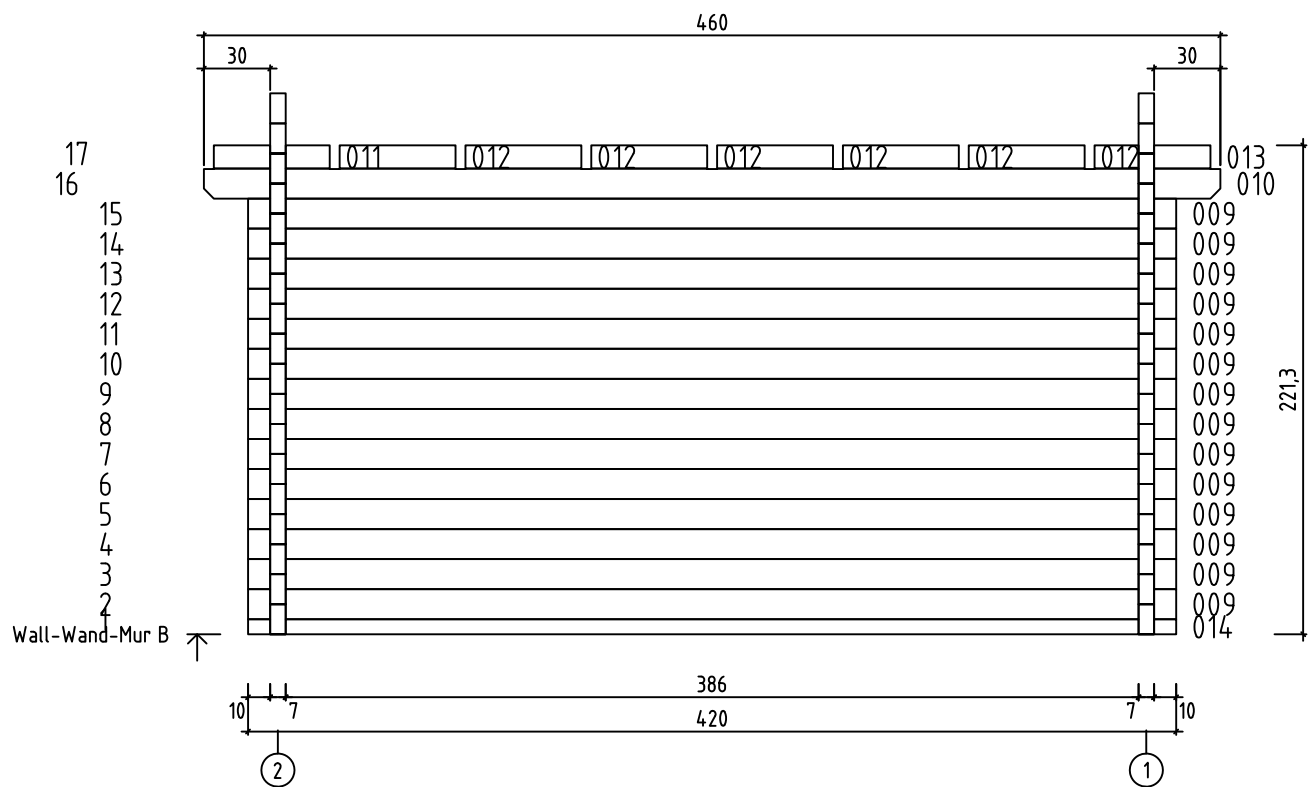
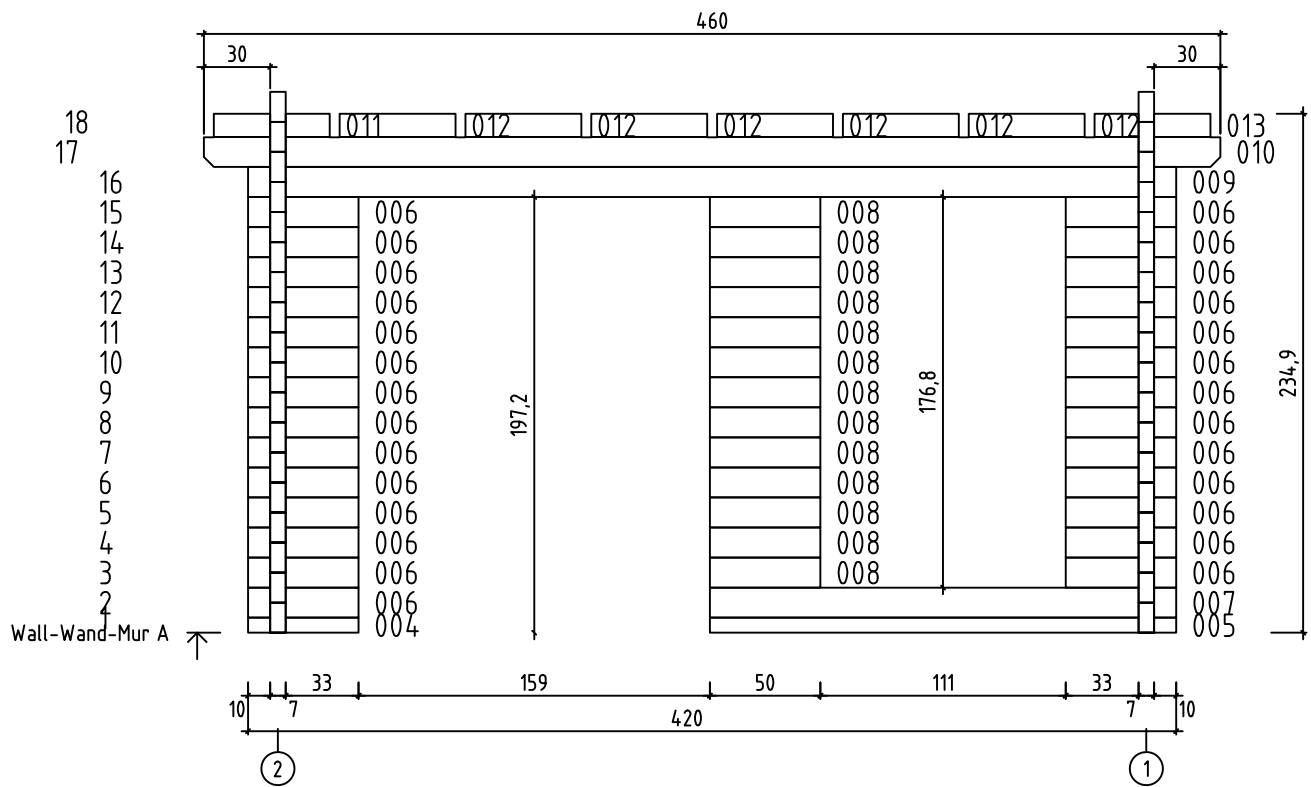



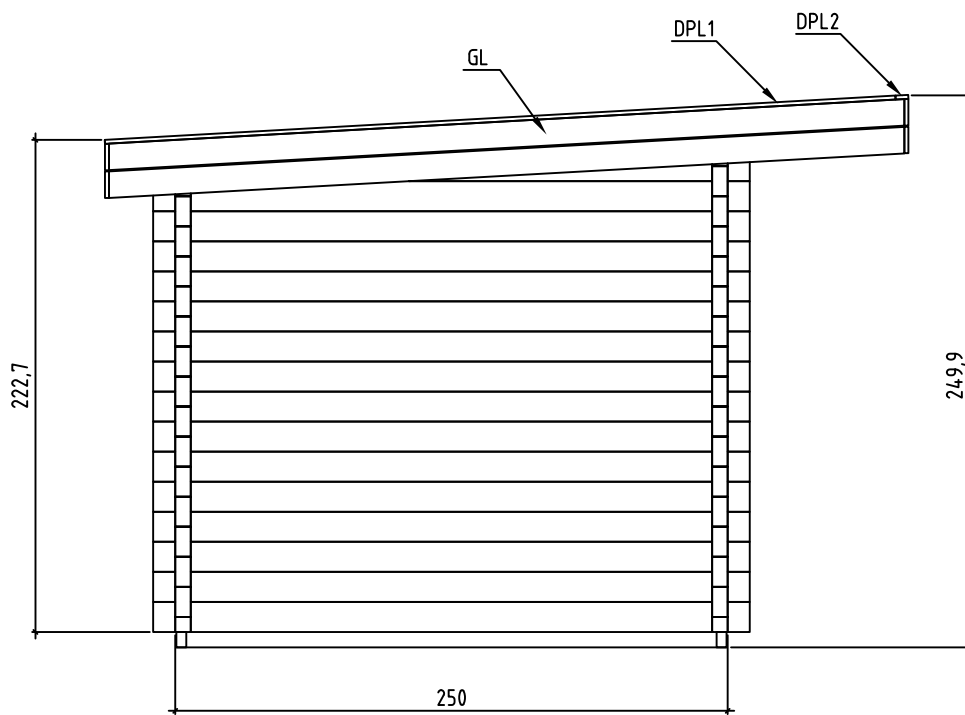
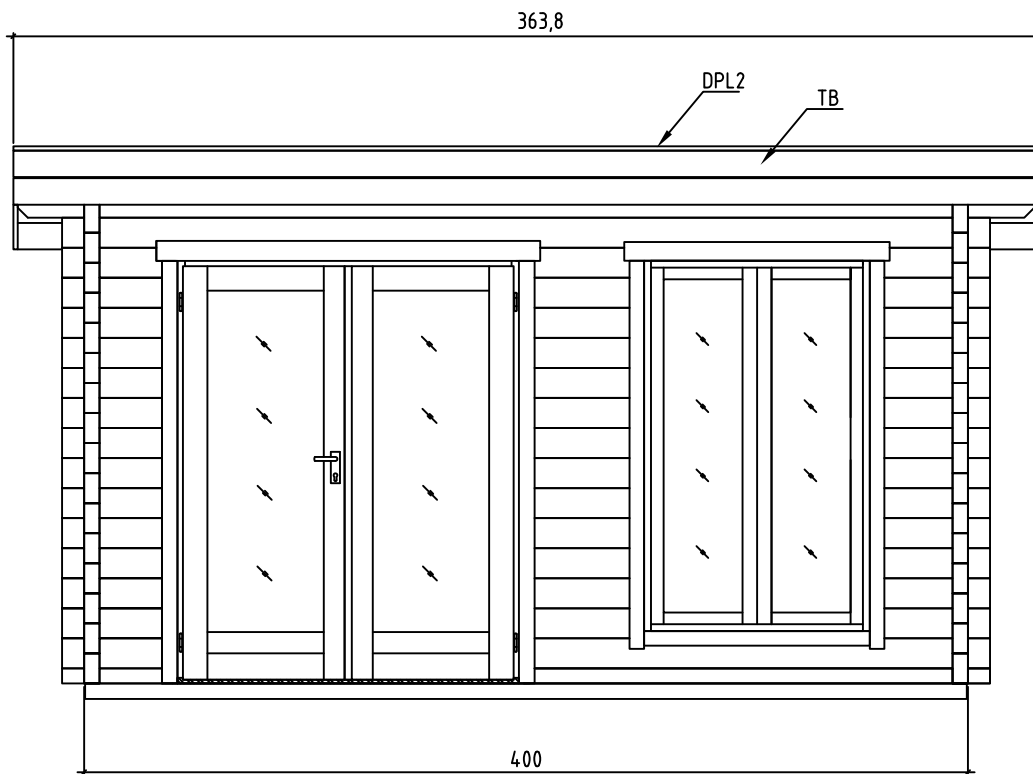



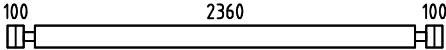

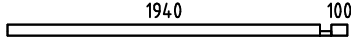

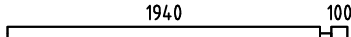

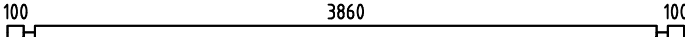
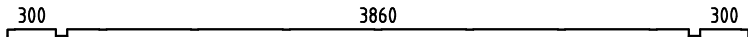



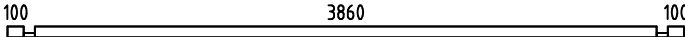
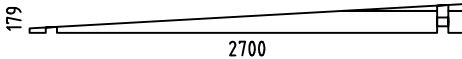
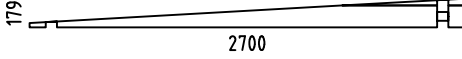
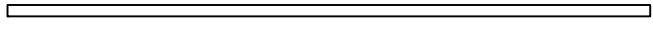
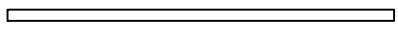
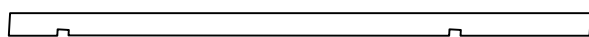



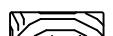

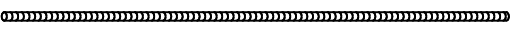



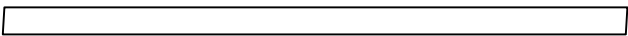



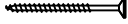
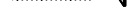

Pos	DORSET 71, Art.No.709502 Piece list - Stückliste - Liste des pieces	Q.	P (mm)	L (mm)
001		32	70x136	2700
004		1	70x68	500
005		1	70x68	2110
006		27	70x136	500
007		1	70x136	2110
008		13	70x136	500
009		15	70x136	4200
010		2	70x136	4600
011		2	70x105	524
012		12	70x105	524
013		2	70x105	524
014		1	70x68	4200
W1-1		1		
W2-1		1		
IAR1	FOUNDATION - FUNDAMENT - FONDATION 	2	45x70	3990
IAR2	FOUNDATION - FUNDAMENT - FONDATION 	9	45x70	2400
SR1	RAFTER - DACHSPARREN - CHEVRON 	9	45x140	3613
	FLOOR BOARDS - FUSSBODENBRETTER - LAME DE PLANCHER 	27	90x18	3856
	ROOF BOARDS - DACHBRETTER - VOLIGES 	40	90x18	4600
	FLOOR FILLET-FUSSBODENLEISTE - CORNIERE DE FINITION DU PLANCHER 		18x18	12.42
DPL1	ROOFING FELT FILLET - DACHPAPPENLEISTE - BAGUETTE DE FIXATION DU FEUTRE BITUMEUX 	2	18x58	3584
DPL2	ROOFING FELT FILLET - DACHPAPPENLEISTE - BAGUETTE DE FIXATION DU FEUTRE BITUMEUX 	1	18x58	4638
M12	TREADED ROD M12 - GEWINDESTANGE M12 - TIGE FILETÉE M12 	2		235
M12	TREADED ROD M12 - GEWINDESTANGE M12 - TIGE FILETÉE M12 	2		380
M12	TREADED ROD M12 - GEWINDESTANGE M12 TIGE FILETÉE M12 	4		2000

Pos	DORSET 71, Art.No.709502 Piece list - Stückliste - Liste des pieces			Q.	P (mm)	L (mm)
LPL	FIXING FILLET - FIXIRUNGSLEISTE - PROFIL DE FIXATION		2	20x70	1060	
LPL	FIXING FILLET - FIXIRUNGSLEISTE - PROFIL DE FIXATION		1	20x70	1540	
LPL	FIXING FILLET - FIXIRUNGSLEISTE - PROFIL DE FIXATION		2	20x70	1729	
LPL	FIXING FILLET - FIXIRUNGSLEISTE - PROFIL DE FIXATION		2	20x70	1933	
TB	EAVES BOARD - TRAUFBRETT - BANDEAU DE TOIT		4	18x120	4638	
GL	GABLE MOULDING - GIEBELLEISTE PLANCHE DE RIVE		4	18x120	3612	
KL4	LENGTHENING BOLT FOR TREADED ROD - VERLÄNGERUNGSMUTTER FÜR GEWINDESTANGE - MANCHON DE RACCORDEMENT DE TIGE FILETÉE		4			
KL1	DRIVE NUT TREADED ROD - EINSHLAGMUTTER FÜR GEWINDESTANGE - ÉCROU A FRAPPER POUR TIGE FILTÉE		4			
KL2	NUT FOR TREADED ROD - MUTTER FÜR GEWINDESTANGE - ÉCROU POUR TIGE FILETÉE		4			
KL3	PLAIN WASHER TREADED ROD - UNTERLEGSSCHEIBE FÜR GEWINDESTANGE - RONDELLE PLATE POUR TIGE FILETÉE		4			
HS83	SCREW FOR FIXING FILLET - SCHRAUBEN FÜR FIXIRUNGSLEISTE - VIS POUR PROFIL DE FIXATION		33	3.5x50		
HS32	SCREW FOR EAVES BOARDS - SCHRAUBEN FÜR TRAUFBRETT - VIS DE FIXATION POUR BANDEAU DE TOIT		36	3.5x50		
HS16	SCREW FOR GABLE MOULDING - SCHRAUBEN FÜR GIEBELLEISTE - VIS DE FIXATION POUR PLANCHE DE RIVE		28	3.5x50		
NFD	SCREW FOR ROOFING FELT FILLET - SCHRAUBEN FÜR DACHPAPPENLEISTE - VIS POUR BAGUETTE FIXATION FEUTRE BITUMEUX		26	4x40		
HS40	SCREW FOR 1. WALL BEAM - SCHRAUBE FÜR 1. BOHLENREIHE - VIS DE FIXATION DES FONDATIONS		7	5x120		
HS39	SCREW FOR FUNDAMENT - SCHRAUBEN ZUR BEFESTIGUNG FUNDAMENT - VIS POUR FONDATION		24	5x90		
HS63	SCREW FOR RAFTER - SCHRAUBEN ZUR BEFESTIGUNG DACHSPARREN - VIS POUR CHEVRON		18	6x150		
HS48	SCREW FOR Pos. 011-013 - SCHRAUBEN FÜR für Pos. 011-013 VIS POUR FIXATION DERNIÈRE RANGÉE MADRIERS (Pos. 011-013)		32	6x150		
MS	SCREW FOR DOORSTEP - SCHRAUBEN FÜR TÜRSCHWELLE - VIS DE FIXATION DU SEUIL DE PORTE		3	4.5x65		
SH70	HAMMER BLOCK - SCHLAGHOLZ - CALLE DE FRAPPE		1			
NFF	ZN NAIL FOR FILLETS - ZN NÄGEL FÜR LEISTEN - POINTE POUR CORNIERE		25	1.4x40		
NF2	ZN NAIL FOR ROOF - ZN NÄGEL FÜR DACHBRETTER - POINTE POUR TOIT		370	2x50		
NH1	ZN NAIL FOR FLOOR - ZN NÄGEL FÜR FUSSBODENBRETTER - CLOUS POUR PLANCHER		196	2x50		
ORZ	MONTAGE SET FOR DOORS AND WINDOWS - MONTAGE-SET FÜR TÜREN UND FENSTER - JEU DE MONTAGE PORTES ET FENETRES		1			



