

*Glencoe*  
*Art.No. 7013302*

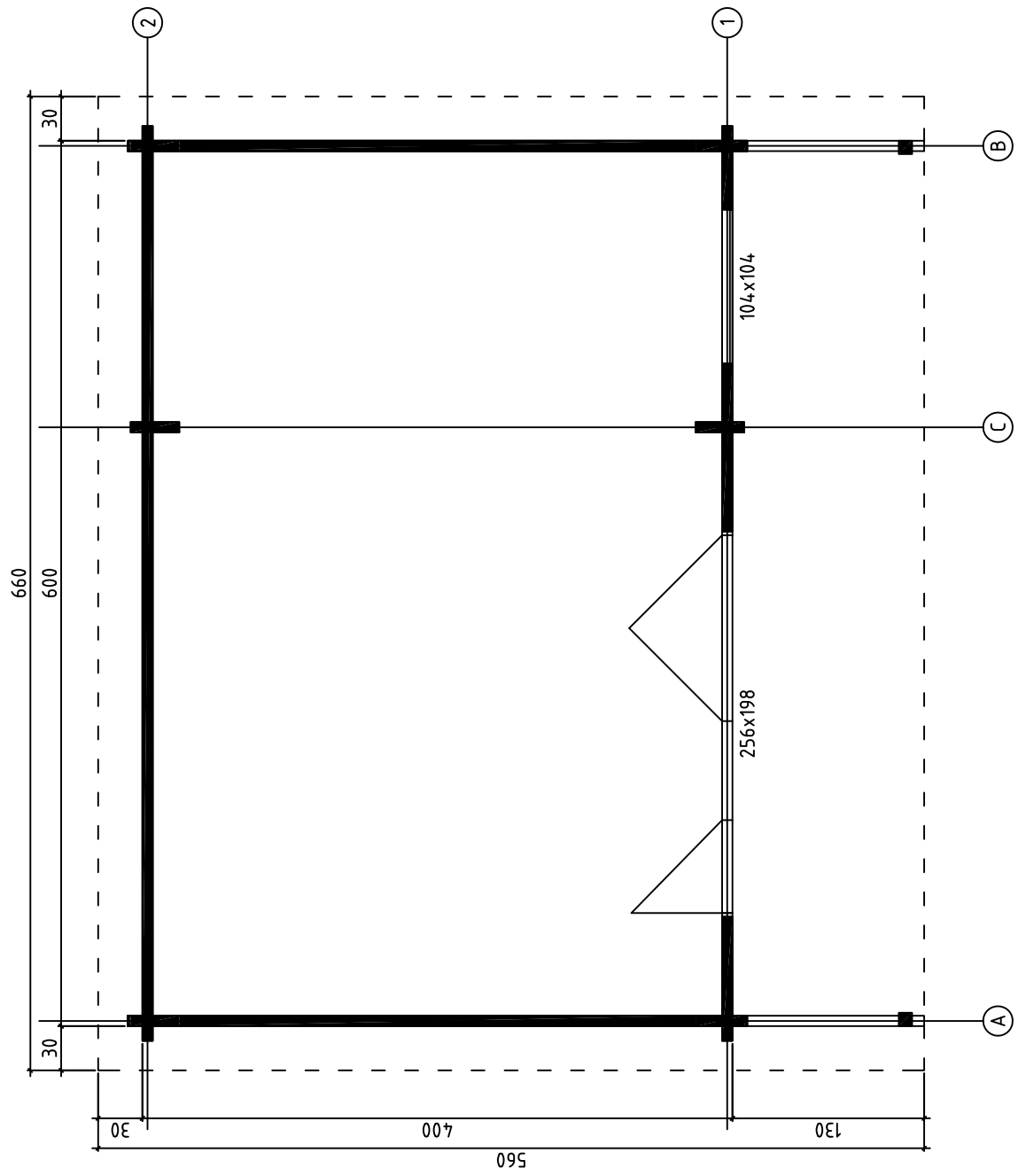

Glencoe, Art.No.7013302  
GROUNDPLAN - GRUNDPLAN - PLAN DE MASSE



Glencoe, Art.No.7013302  
FOUNDATION - FUNDAMENT - FONDATION

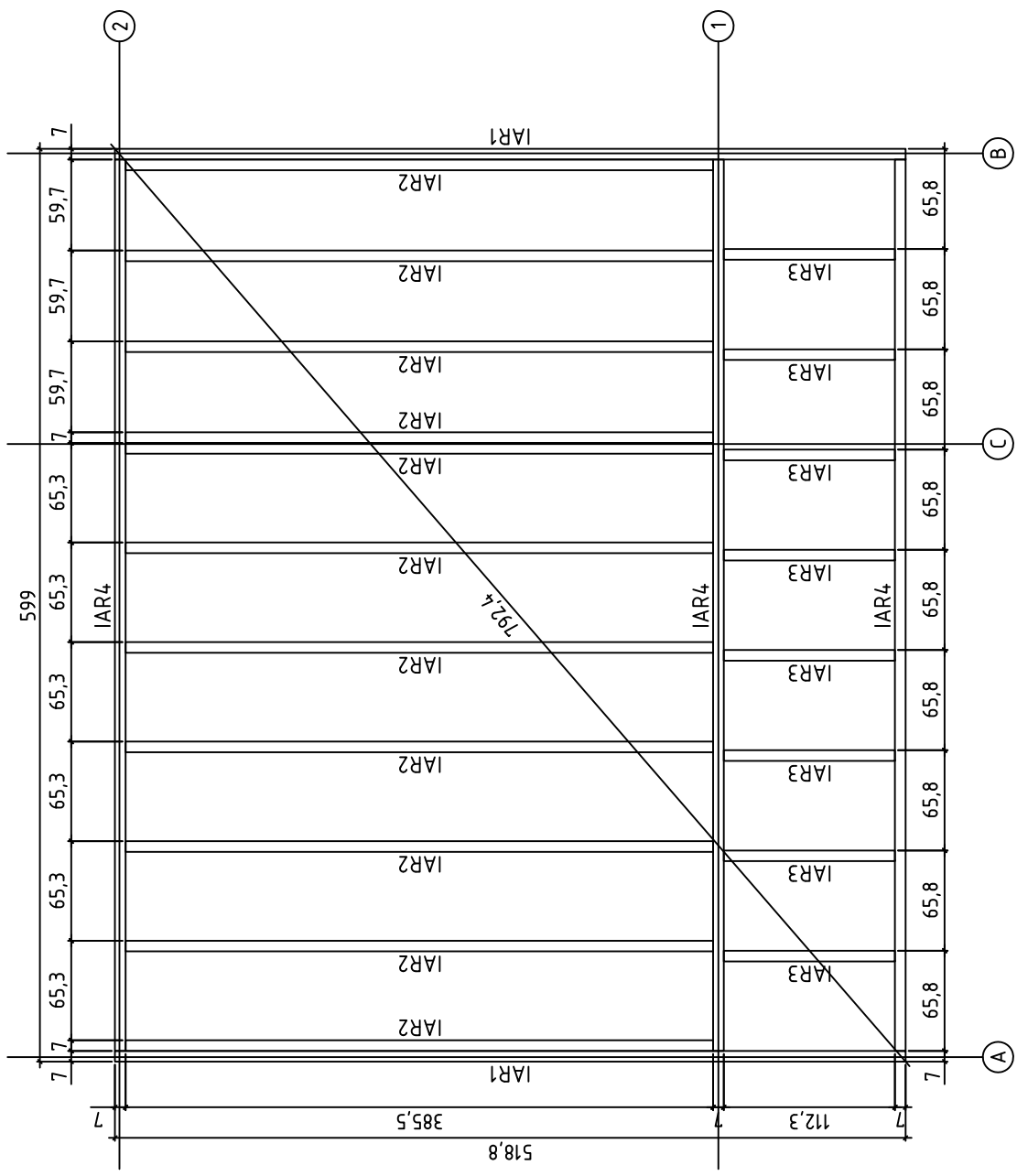

Glencoe, Art.No.7013302  
RAFTERS PLAN - DACHSPARREN - PLAN DE CHEVRON

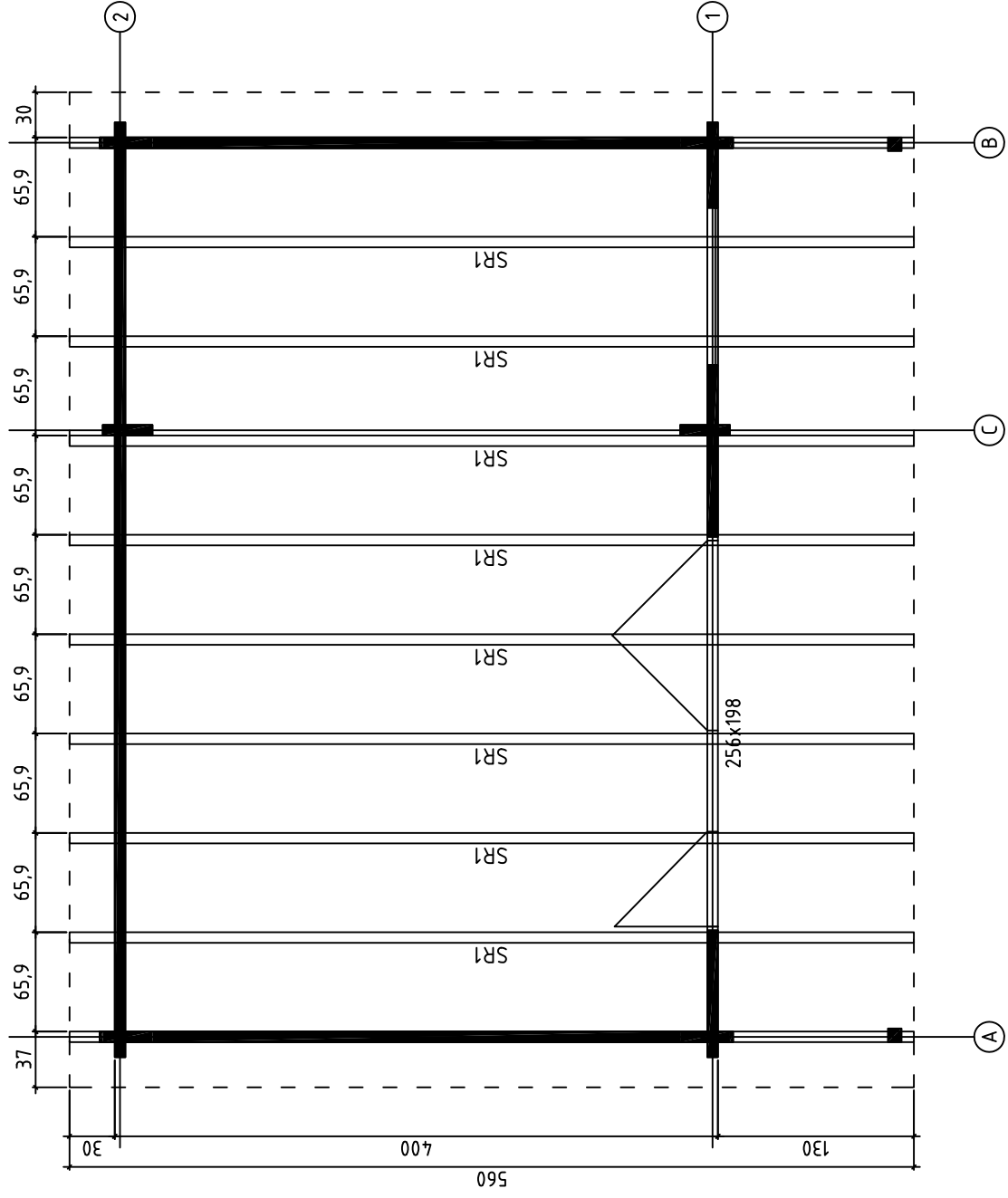

Glencoe, Art.No.7013302  
FLOOR BOARDS - FUSSBODENBRETTER - PLAN POSE PLANCHER

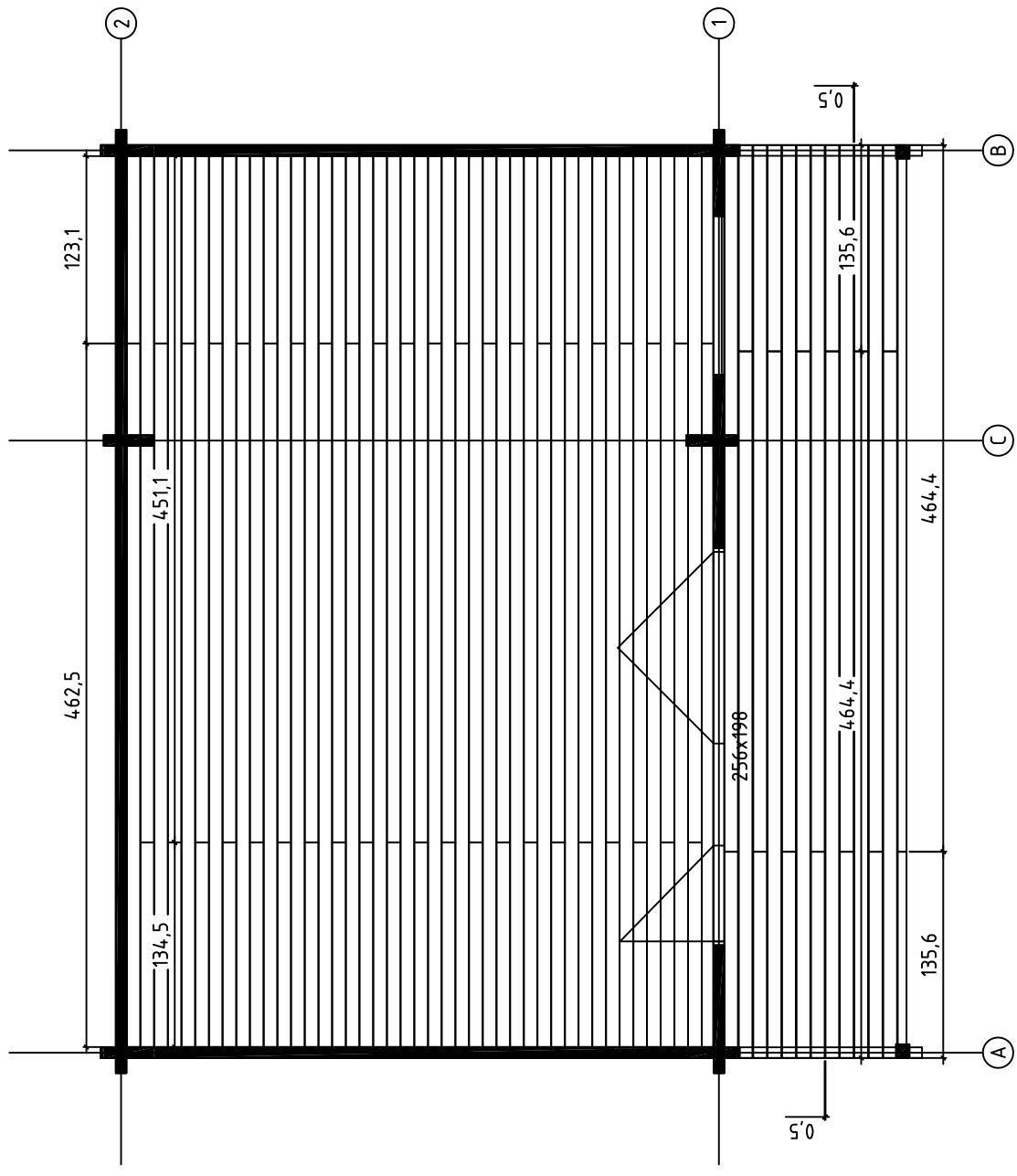

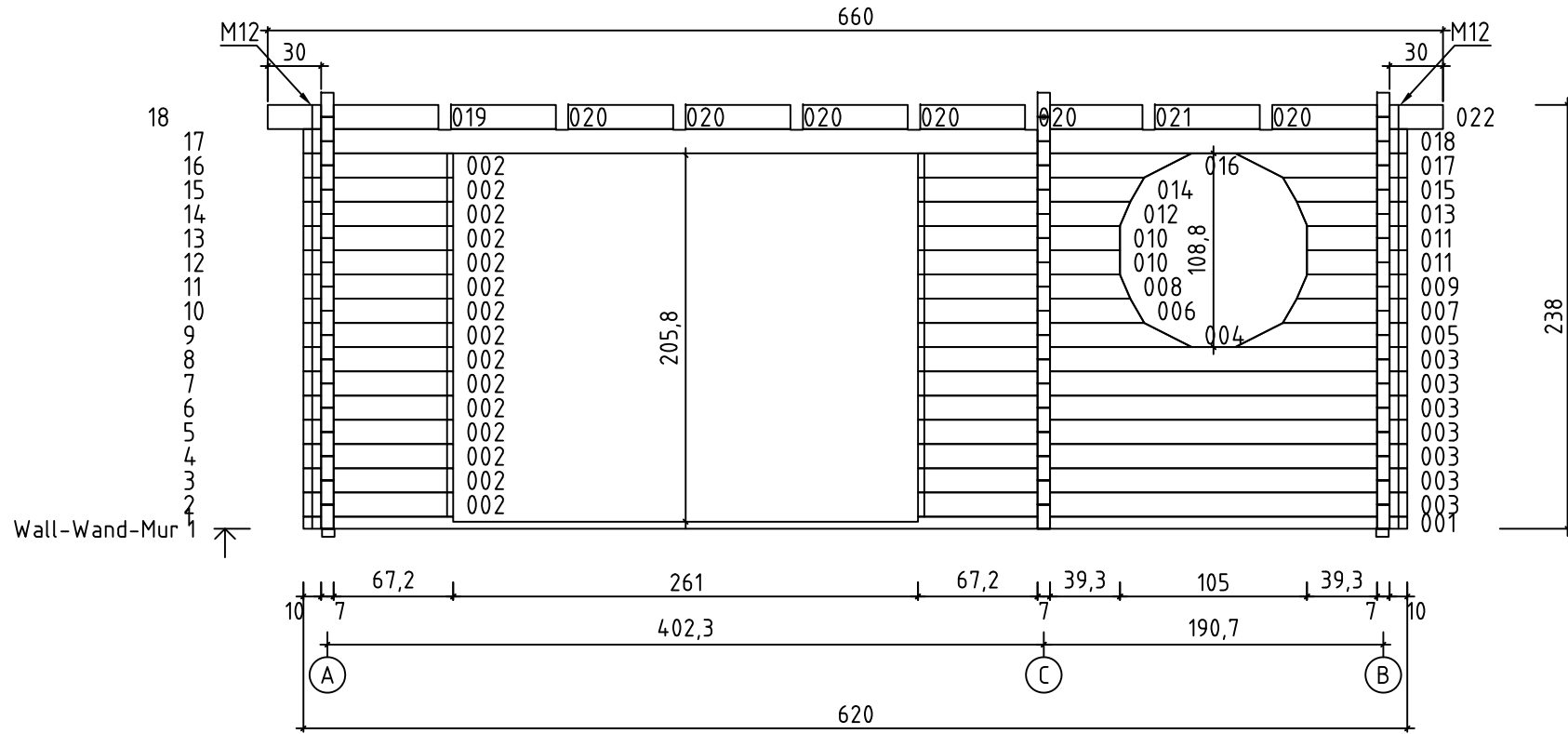

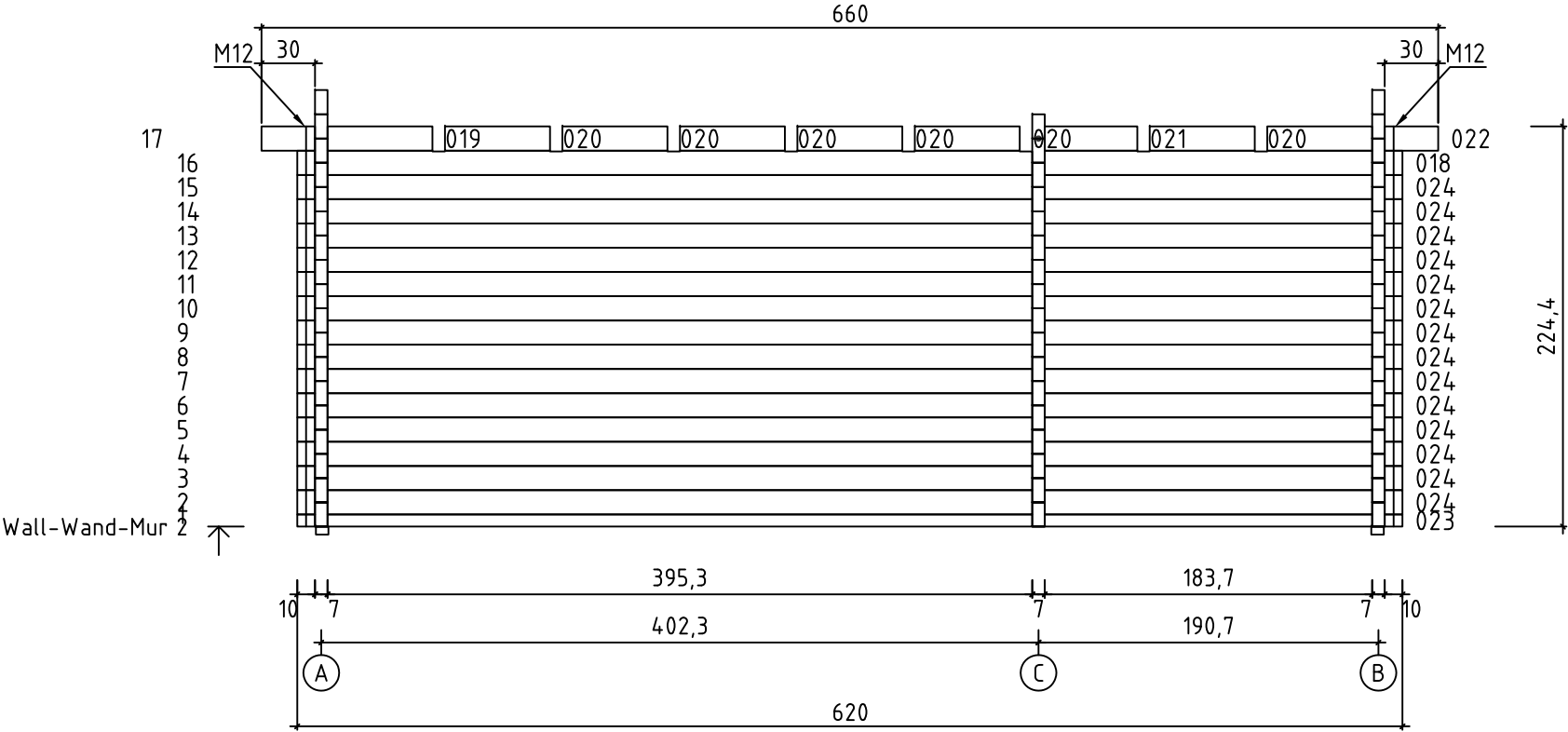

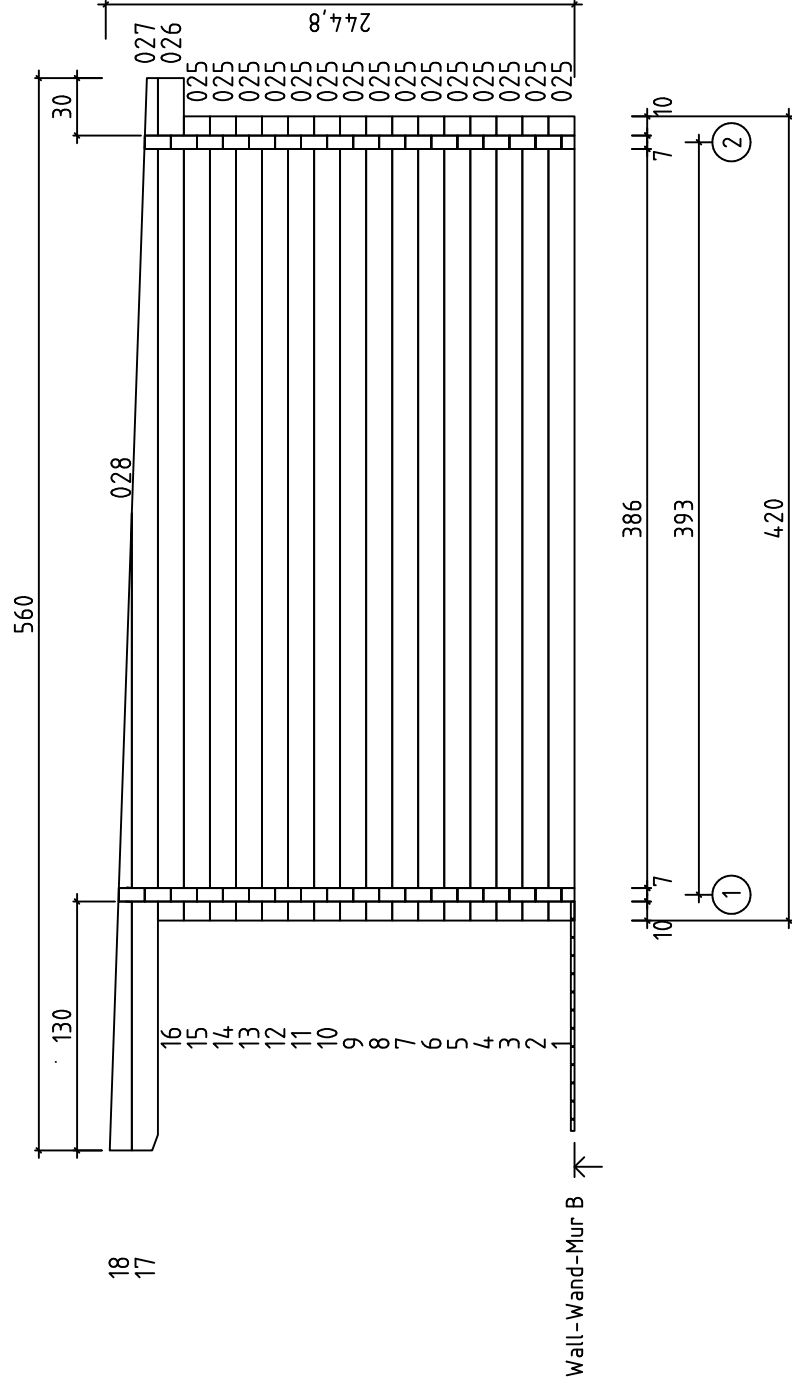
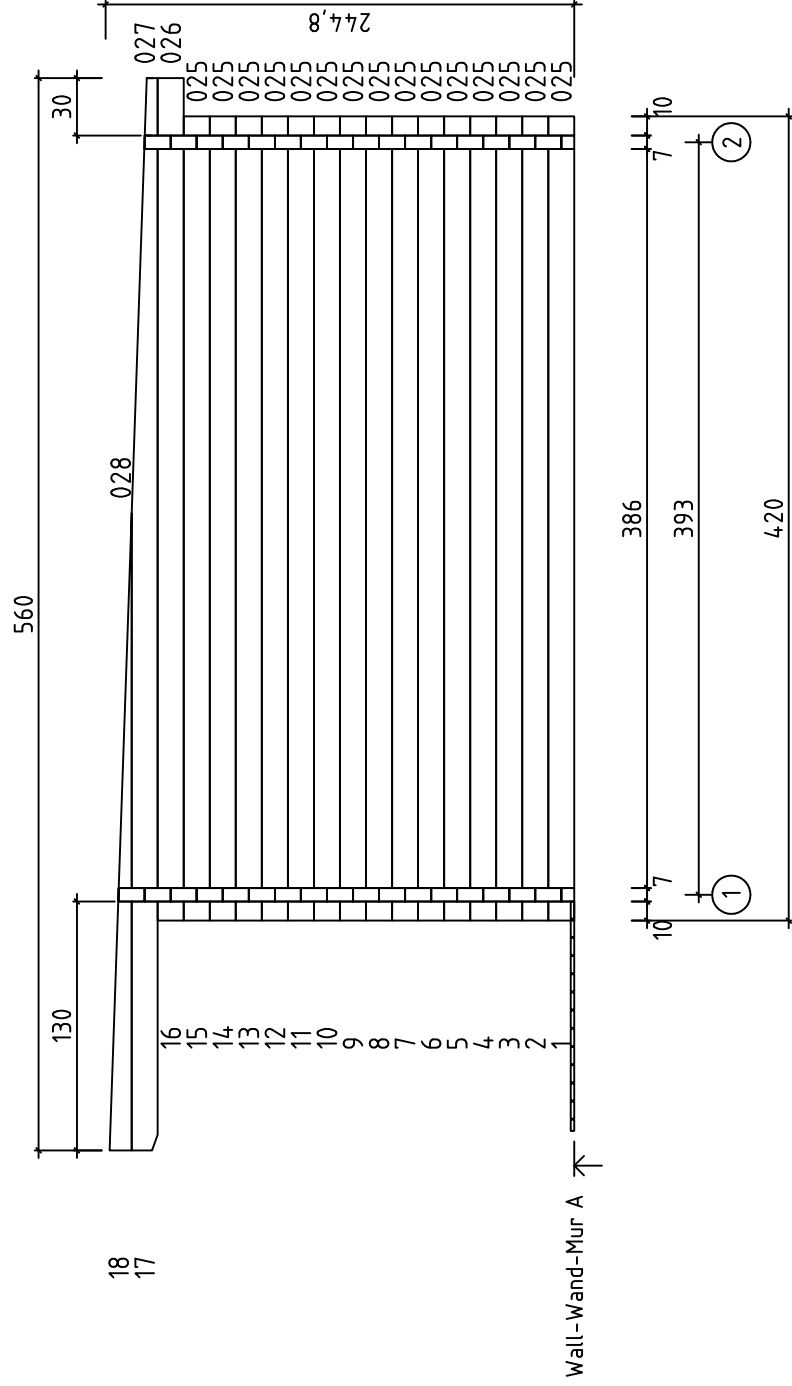



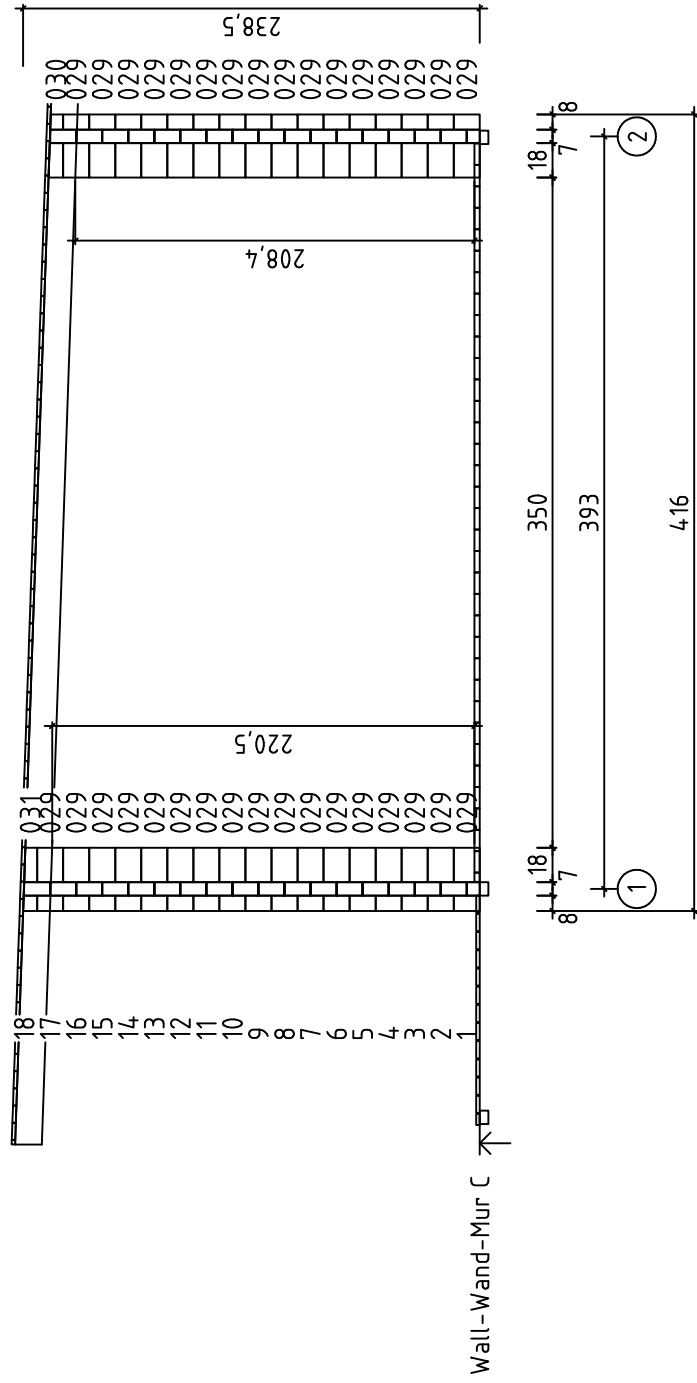

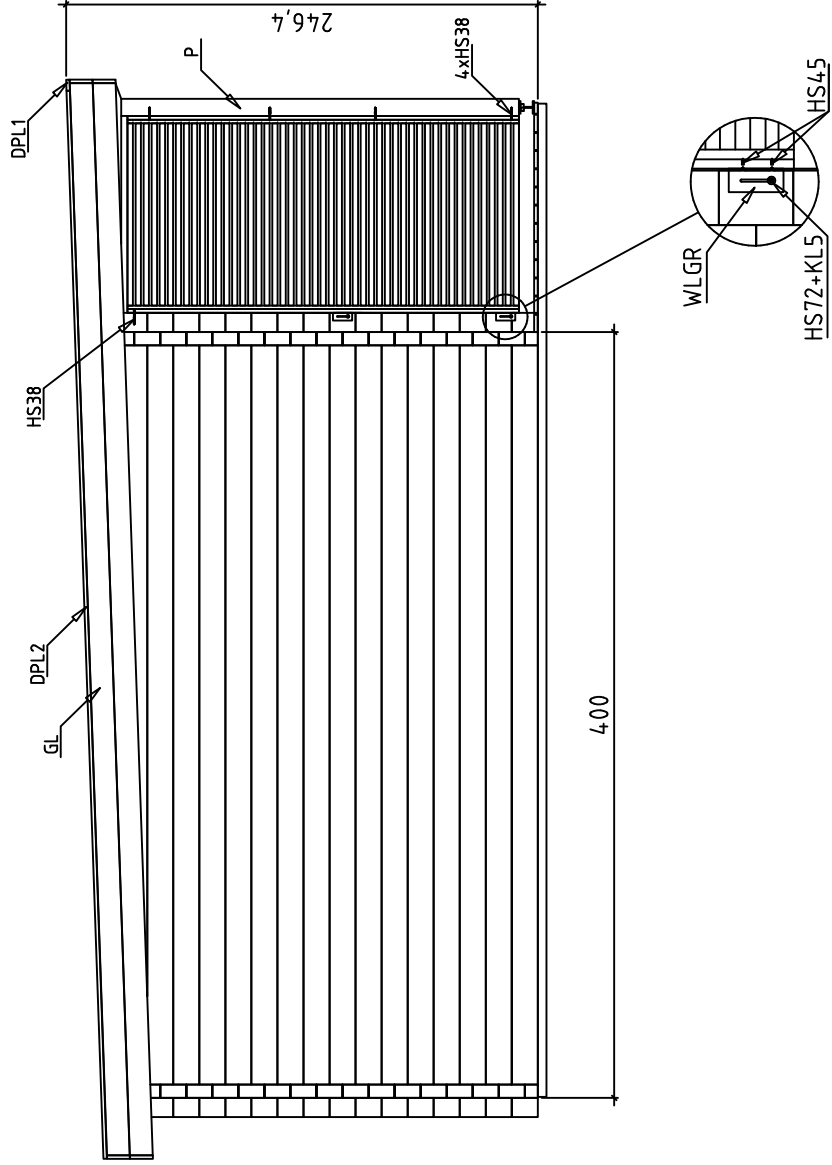
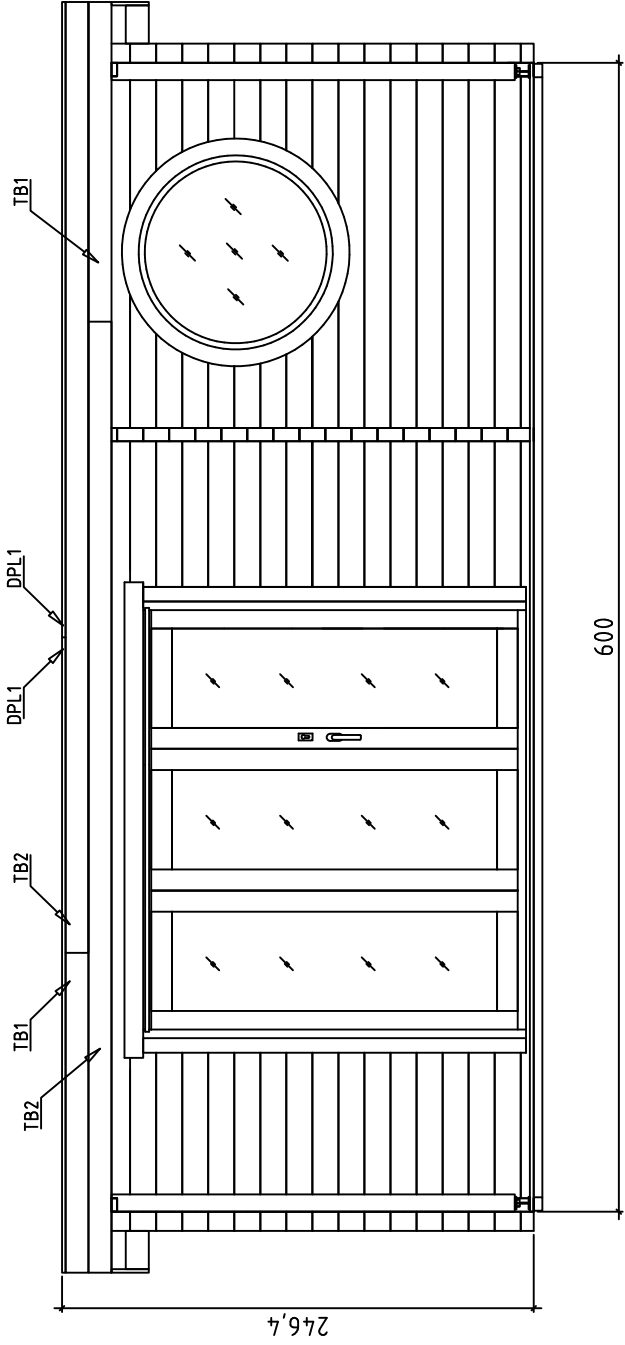



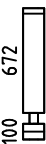

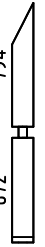
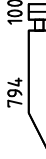

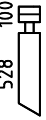
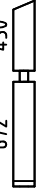





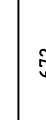
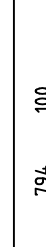
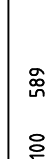
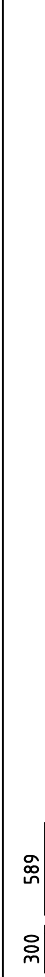

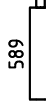
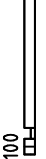
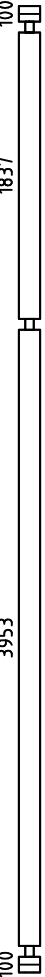



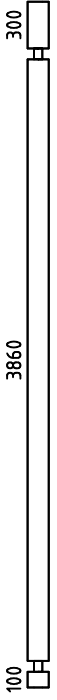

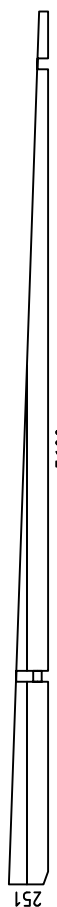
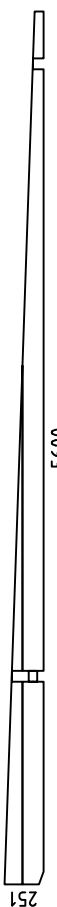
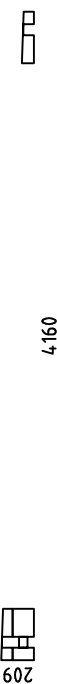



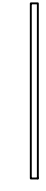
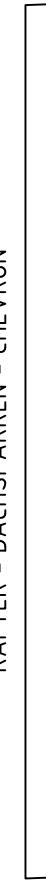





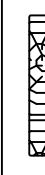



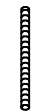

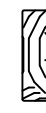









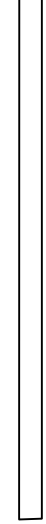









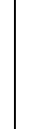

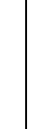
Pos	Glencoe, Art.No.7013302 Piece list - Stückliste - Liste des pieces	Q.	P (mm)	L (mm)
001		1	70x68	6200
002		15	70x136	842
003		7	70x136	2748
004		1	70x136	1536
005		1	70x136	964
006		1	70x136	1270
007		1	70x136	698
008		1	70x136	1192
009		1	70x136	620
010		2	70x136	1135
011		2	70x136	563
012		1	70x136	1192
013		1	70x136	620
014		1	70x136	1270
015		1	70x136	698
016		1	70x136	1536
017		1	70x136	964
018		2	70x136	6200
019		2	70x136	959
020		12	70x136	589
021		2	70x136	554
022		2	70x136	959
023		1	70x68	6200
024		14	70x136	6200
025		30	70x136	4200

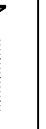
Pos	Glencoe, Art.No.7013302 Piece list - Stückliste - Liste des pieces	Q.	P (mm)	L (mm)
026		2	70x136	4400
029		32	70x136	330
WA-1		1		
WB-1		1		
WC-1		1		
IAR4	FOUNDATION - FUNDAMENT - FONDATION 	3	70x45	5850
IAR1	FOUNDATION - FUNDAMENT - FONDATION 	2	70x45	5188
IAR2	FOUNDATION - FUNDAMENT - FONDATION 	11	70x45	3855
IAR3	FOUNDATION - FUNDAMENT - FONDATION 	8	70x45	1123
SR1	RAFTER - DACHSPARREN - CHEVRON 	8	70x140	5608
FB	FLOOR BOARDS - FUSSBODENBRETTER - LAME DE PLANCHER 	22	90x18	4625
FB	FLOOR BOARDS - FUSSBODENBRETTER - LAME DE PLANCHER 	21	90x18	4511
FB	FLOOR BOARDS - FUSSBODENBRETTER - LAME DE PLANCHER 	21	90x18	1345
FB	FLOOR BOARDS - FUSSBODENBRETTER - LAME DE PLANCHER 	22	90x18	1231
	ROOF BOARDS - DACHBRETTER - VOLIGES 	63	90x18	4947
	ROOF BOARDS - DACHBRETTER - VOLIGES 	63	90x18	1653
SV	TERRACE BOARDS - TERRASSENBRETTER - PLANCHER DE TERRASSE 	13	90x19	4644
SV	TERRACE BOARDS - TERRASSENBRETTER - PLANCHER DE TERRASSE 	13	90x19	1356
	FLOOR FILLET-FUSSBODENLEISTE - CORNIERE DE FINITION DU PLANCHER 		15x40	19.4 m.
DPL1	ROOFING FELT FILLET - DACHAPPENLEISTE - BAGUETTE DE FIXATION DU FEUTRE BITUMEUX 	2	18x58	3318
DPL2	ROOFING FELT FILLET - DACHAPPENLEISTE - BAGUETTE DE FIXATION DU FEUTRE BITUMEUX 	2	18x58	5581
M12	TREADED ROD M12 - GEWINDESTANGE M12 - TIGE FILETÉE M12 	2		275
M12	TREADED ROD M12 - GEWINDESTANGE M12 - TIGE FILETÉE M12 	2		410
M12	TREADED ROD M12 - GEWINDESTANGE M12 - TIGE FILETÉE M12 	4		2000
LPL	FIXING FILLET - FIXIRUNGSLEISTE - PROFIL DE FIXATION 	2	20x70	2000

Pos	Glencoe, Art.No.7013302 Piece list - Stückliste - Liste des pieces	Q.	P (mm)	L (mm)
LPL	FIXING FILLET - FIXIRUNGSLEISTE - PROFIL DE FIXATION 	1	20x70	2560
P	POST - PFOSTEN - POTEAU 	2	90x90	2145
TB1	EAVES BOARD - TRAUFBRETT - BANDEAU DE TOIT 	4	18x120	1672
TB2	EAVES BOARD - TRAUFBRETT - BANDEAU DE TOIT 	4	18x120	4966
DRV	ROOF EDGE REINFORCEMENT - DACHRANDVERSTÄRKUNG - CORNIERE DE RENFORT DE BORD DE TOIT 	2	28x34	299
DRV	ROOF EDGE REINFORCEMENT - DACHRANDVERSTÄRKUNG - CORNIERE DE RENFORT DE BORD DE TOIT 	2	28x34	1299
DRV	ROOF EDGE REINFORCEMENT - DACHRANDVERSTÄRKUNG - CORNIERE DE RENFORT DE BORD DE TOIT 	2	28x34	3861
TBE6	FIXING FILLET FOR DOOR - FIXIRUNGSLEISTE FÜR TÜR - PROFIL DE FIXATION DES PORTES 	2	28x34	1970
GL	GABLE MOULDING - GIEBELLEISTE PLANCHE DE RIVE 	4	18x120	5608
KL4	LENGTHENING BOLT FOR TREADED ROD - VERLÄNGERUNGSMUTTER FÜR GEWINDESTANGE - MANCHON DE RACCORDEMENT DE TIGE FILETÉE 	4		
KL1	DRIVE NUT TREADED ROD - EINSHLAGMUTTER FÜR GEWINDESTANGE - ÉCROU A FRAPPER POUR TIGE FILITÉE 	4		
KL2	NUT FOR TREADED ROD - MUTTER FÜR GEWINDESTANGE - ÉCROU POUR TIGE FILETÉE 	4		
KL3	PLAIN WASHER TREADED ROD - UNTERLEGSCHIBE FÜR GEWINDESTANGE - RONDELLE PLATE POUR TIGE FILETÉE 	4		
HS83	SCREW FOR FIXING FILLET - SCHRAUBEN FÜR FIXIRUNGSLEISTE - VIS POUR PROFIL DE FIXATION 	17	3.5x50	
HS32	SCREW FOR EAVES BOARDS - SCHRAUBEN FÜR TRAUFBRETT - VIS DE FIXATION POUR BANDEAU DE TOIT 	104	3.5x50	
HS84	SCREW FOR FIXING FILLET - SCHRAUBEN FÜR FIXIRUNGSLEISTE - VIS POUR PROFIL DE FIXATION 	10	3.5x50	
HS16	SCREW FOR GABLE MOULDING - SCHRAUBEN FÜR GIEBELLEISTE - VIS DE FIXATION POUR PLANCHE DE RIVE 	48	3.5x80	
HS38	SCREW FOR FIXING TERRACE RAILING - SCHRAUBE FÜR TERRASSE VIS DE FIXATION DE GARDE-CORPS DE TERRASSE 	10	4.5x80	
HS45	SCREW FOR SLIDING WALL TIE - SCHRAUBEN FÜR WAND SCHIEBEREGLER - VIS POUR FIXATION ÉQUERRE MÉTALLIQUE AU PARAVENT 	16	4x20	
NFD	SCREW FOR ROOFING FELT FILLET - SCHRAUBEN FÜR DACHAPPEN-LEISTE - VIS POUR BAGUETTE FIXATION FEUTRE BITUMEUX 	40	4x40	
HS26	SCREW FOR ROOF EDGE REINFORCEMENT - SCHRAUBEN FÜR DACHRANDVERSTÄRKUNG - VIS POUR RENFORT DE BORD DE TOIT 	30	4x40	
HS34	SCREW FOR POST - SCHRAUBEN FÜR PFOSTEN - VIS DE FIXATION DES POTEAUX 	4	4x60	
HS40	SCREW FOR 1. WALL BEAM - SCHRAUBE FÜR 1. BOHLENREIHE - VIS DE FIXATION DES FONDATIONS 	9	5x120	
HS39	SCREW FOR FUNDAMENT - SCHRAUBEN ZUR BEFESTIGUNG FUNDAMENT - VIS POUR FONDATION 	84	5x120	
HS42	SCREW FOR GABLE - SCHRAUBEN FÜR GIEBEL - VIS POUR FIXATION DES PIGNONS 	8	5x120	





