

Orkney 5
Art.No. 704642

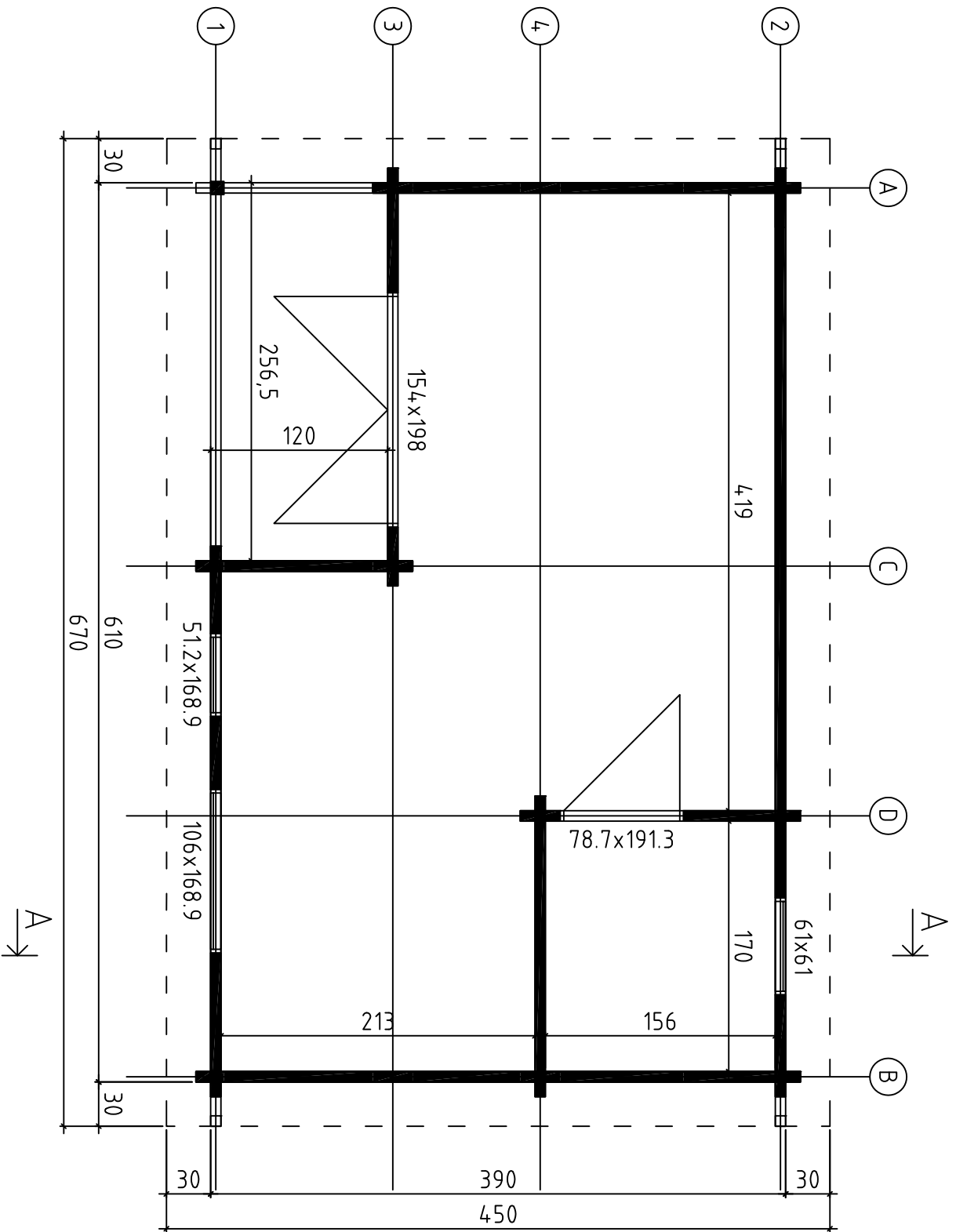

Orkney 5, Art.No.704642
GRUNDPLAN - GRUNDPLAN - PLAN DE MASSE



Orkney 5, Art No. 704642
 FOUNDATION - FUNDAMENT - FONDATION

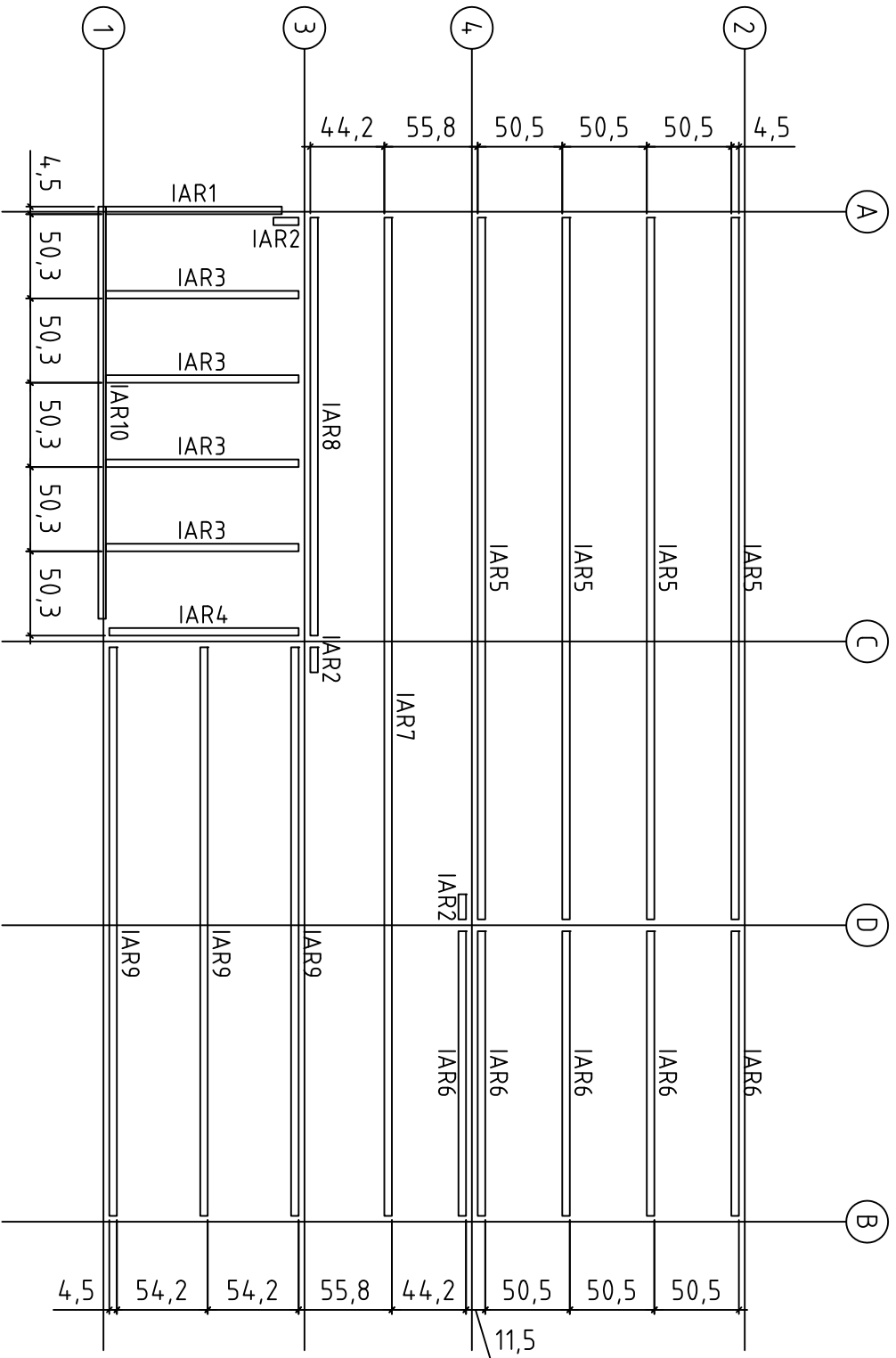

Orkney 5, Art.No.704642
 RAFTERS PLAN - DACHSPARREN - PLAN DE CHEVRON

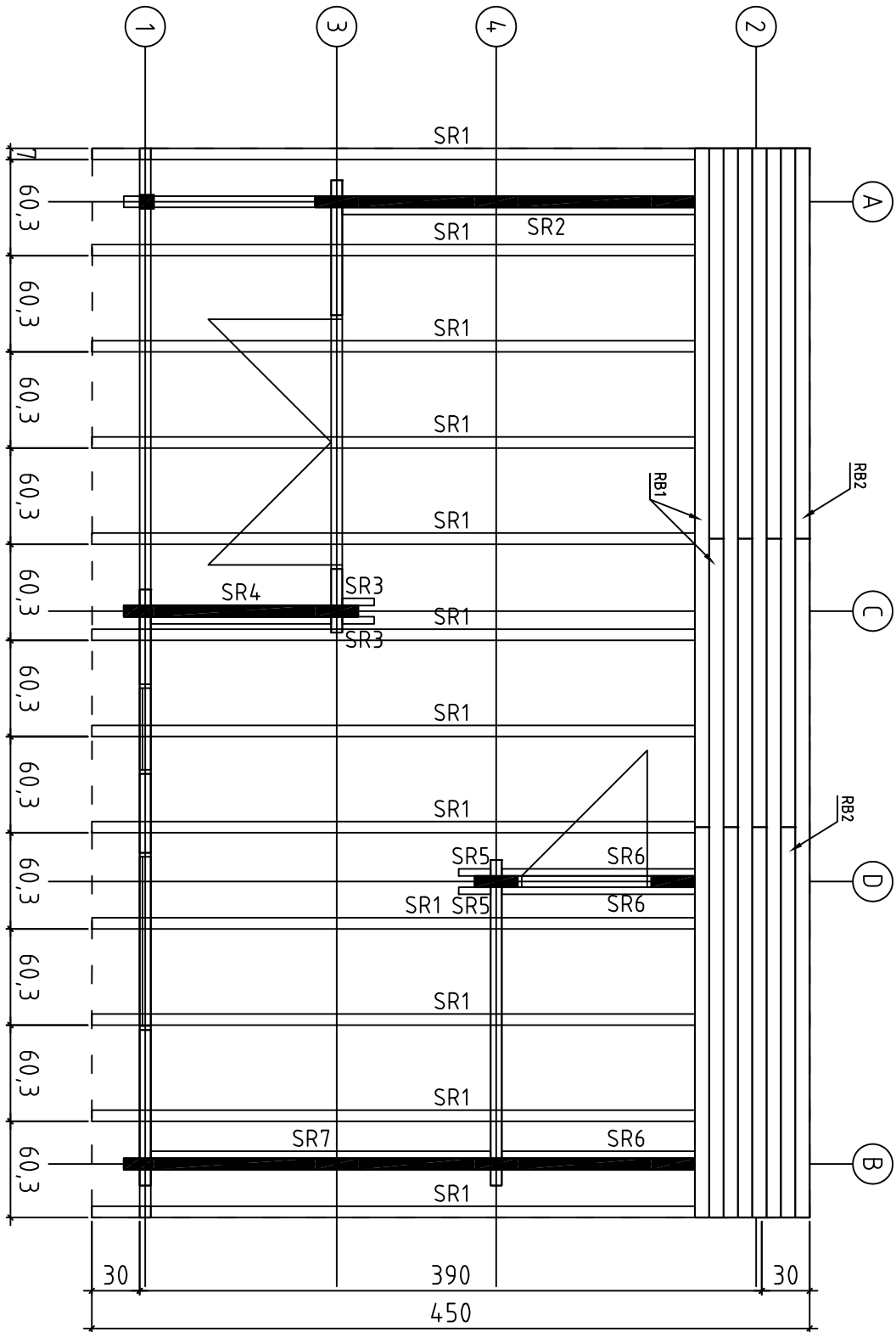

Orkney 5, Art.No.704642
FLOOR BOARDS - FUSSBODENBRETTER - PLAN POSE PLANCHER

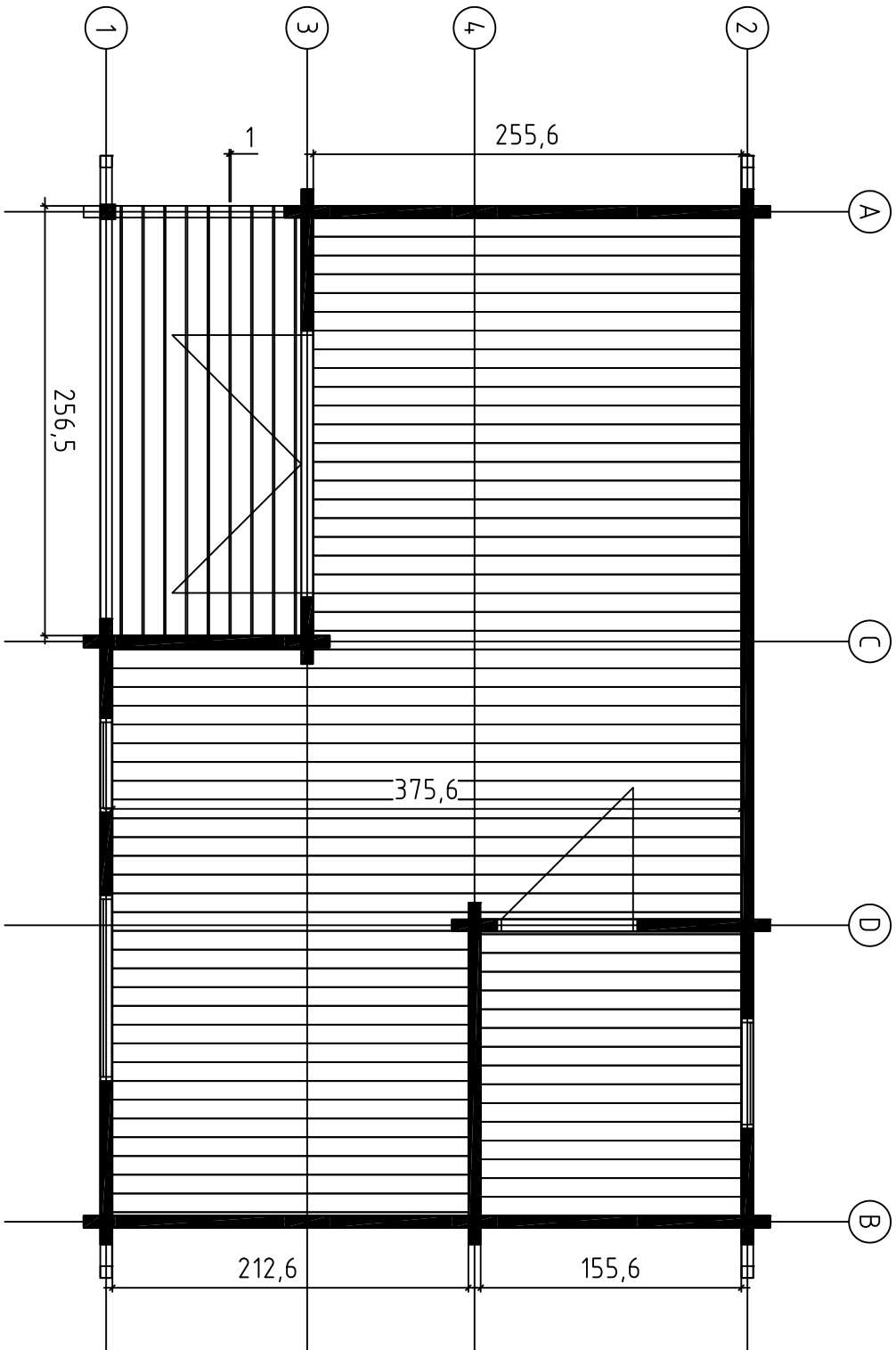

Orkney 5, Art.No.704642
CEILING BOARDS - DECKENBREITER - VOLIGES SOUS PLAFOND

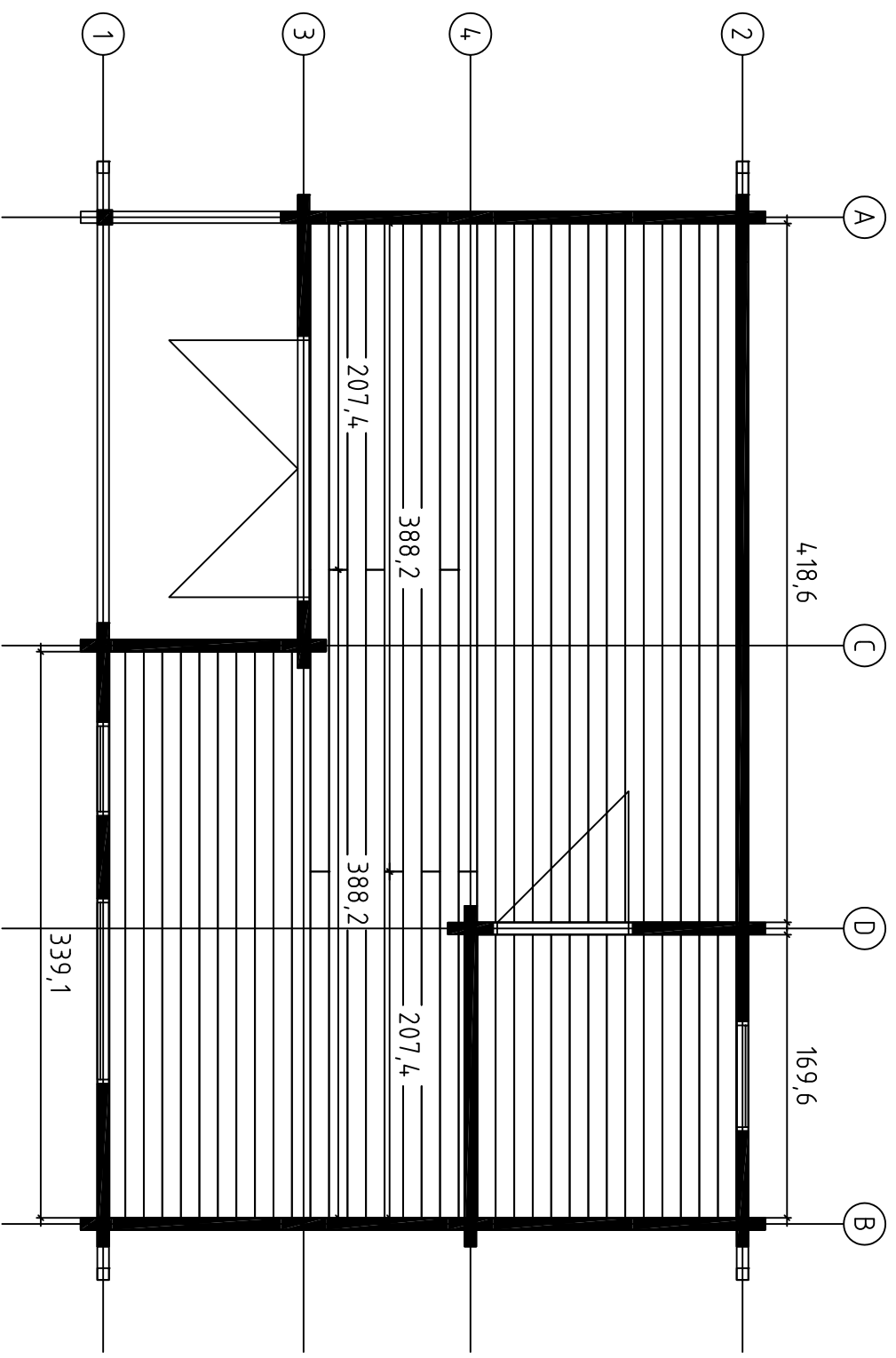

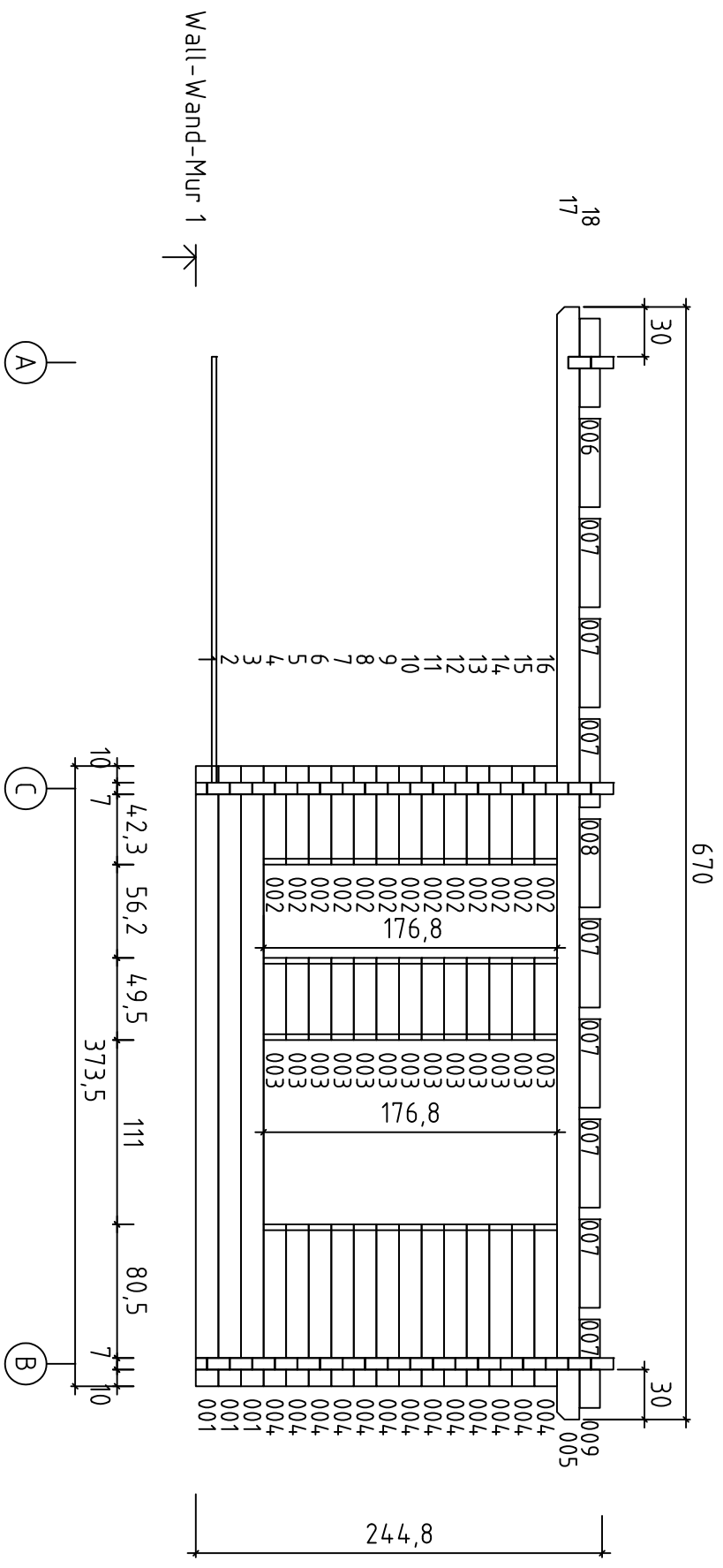

Wall - Wand-Mur 1

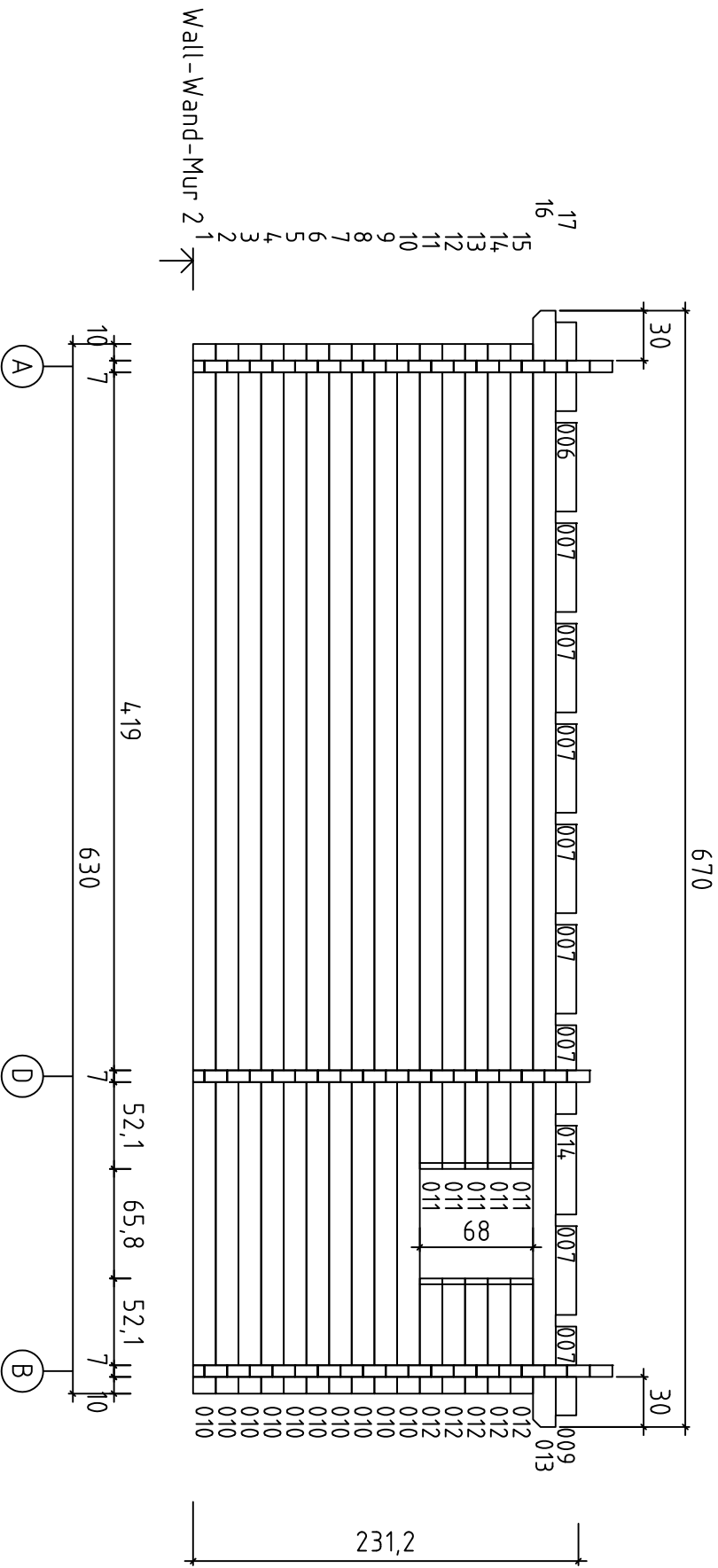

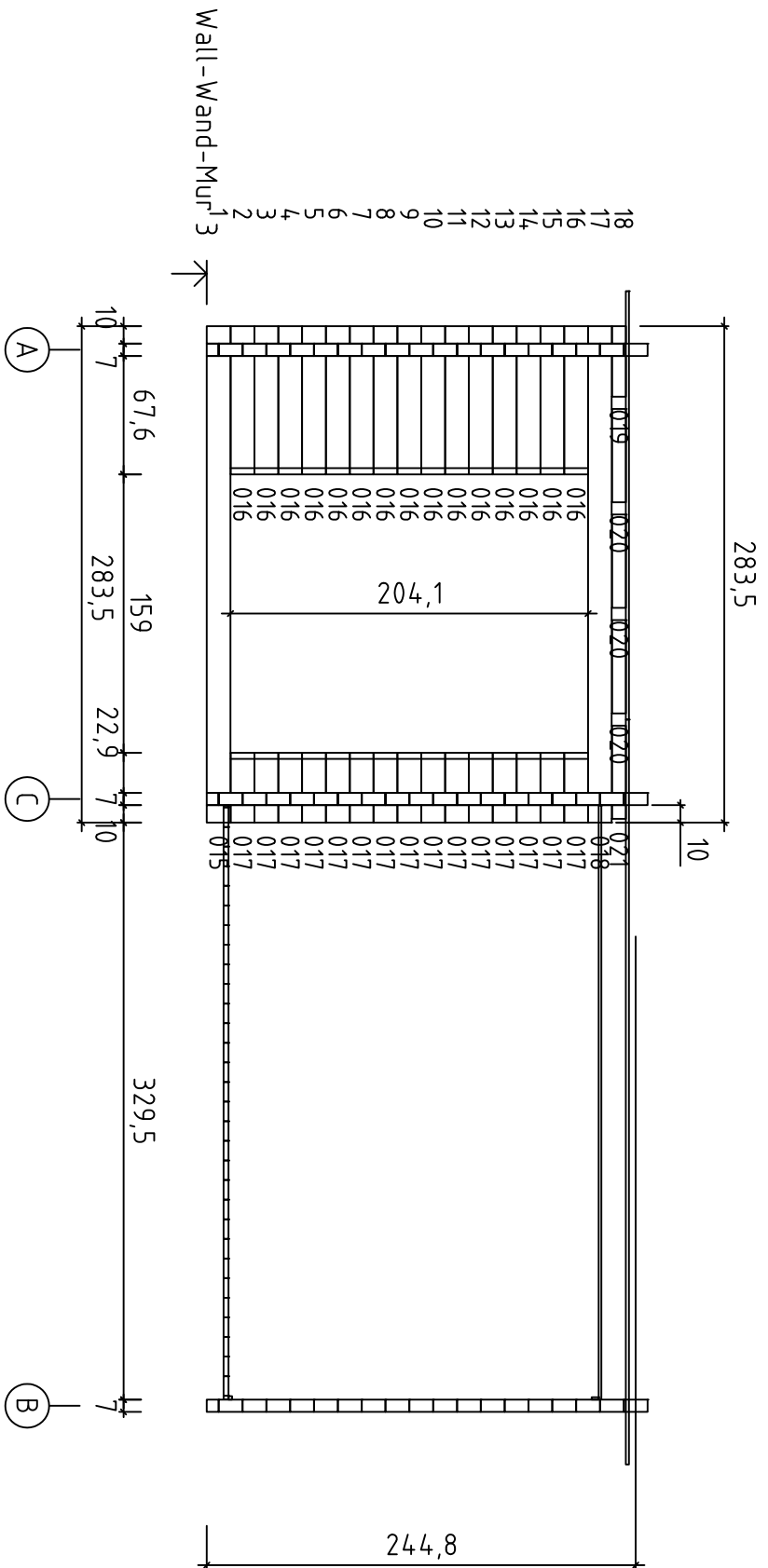

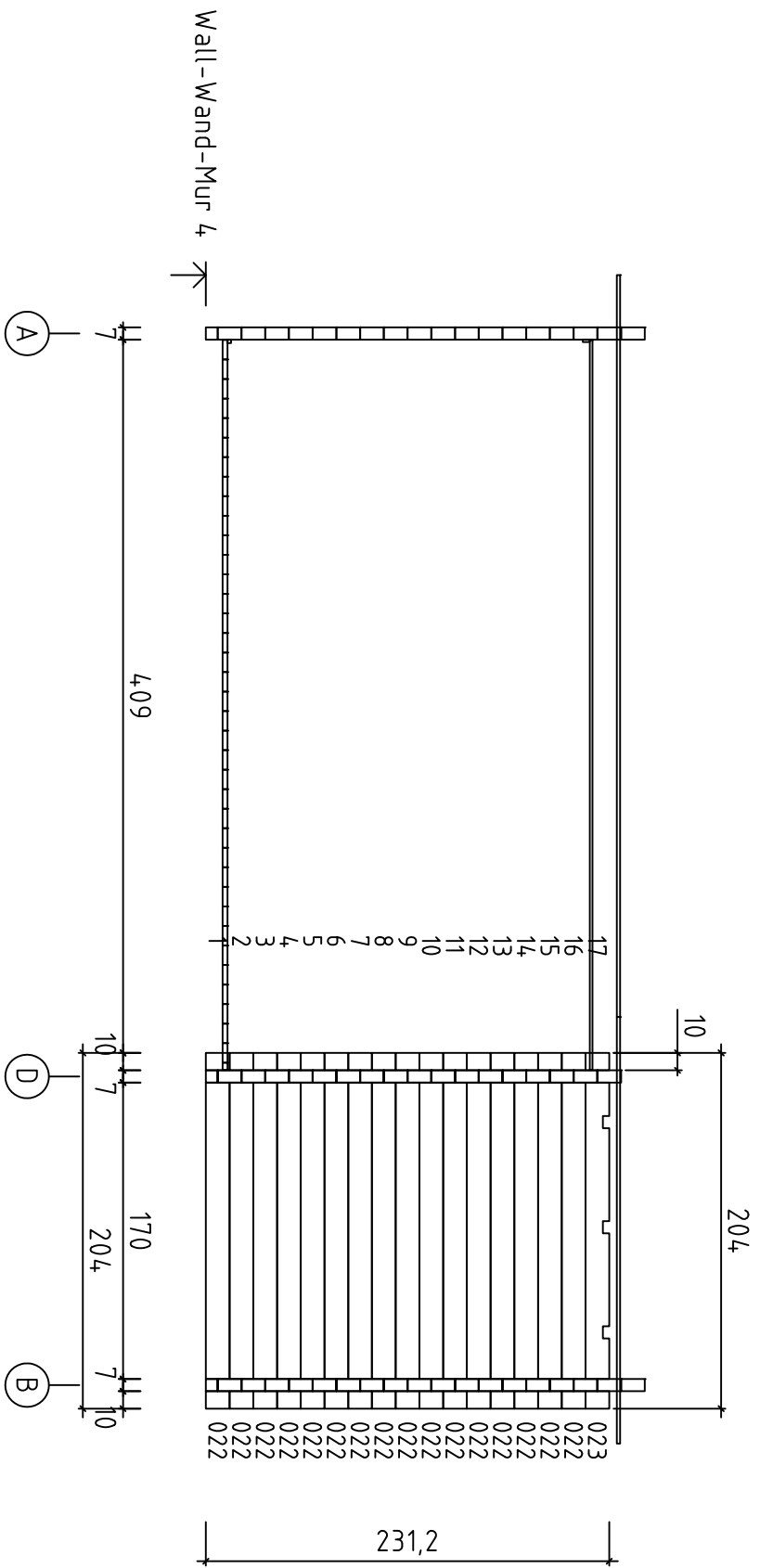

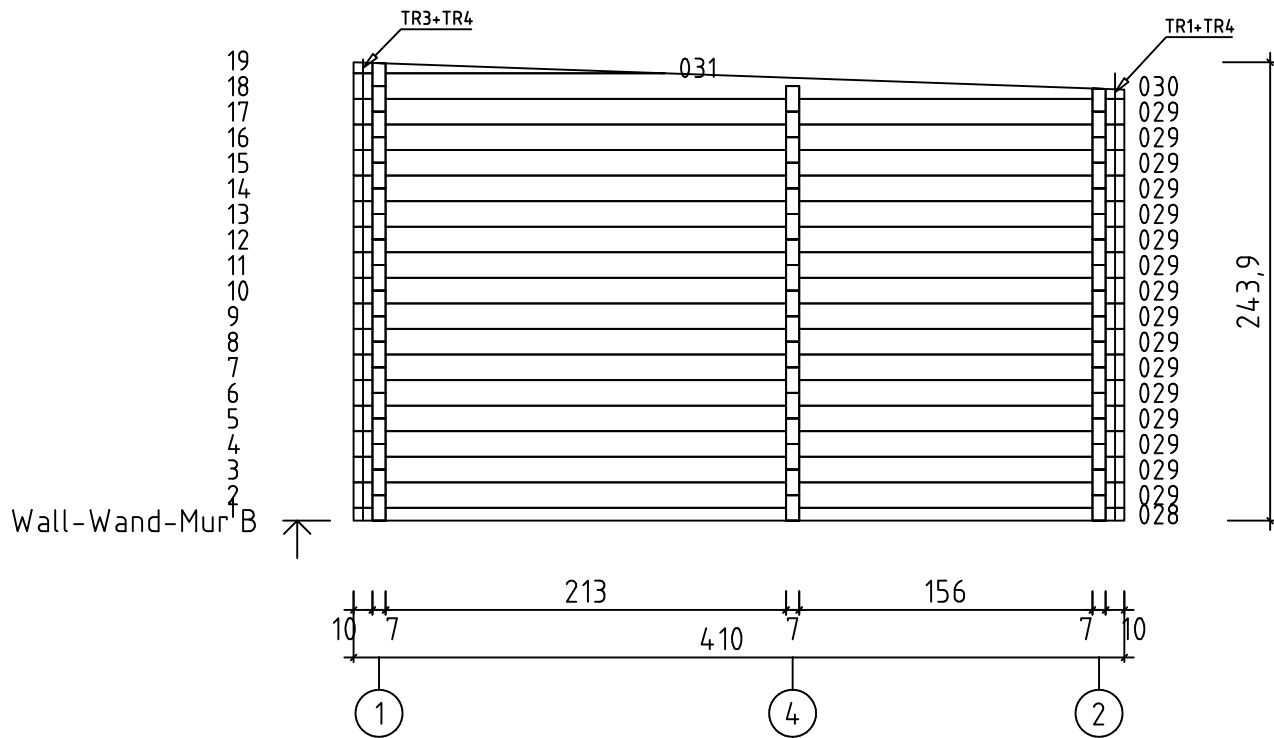
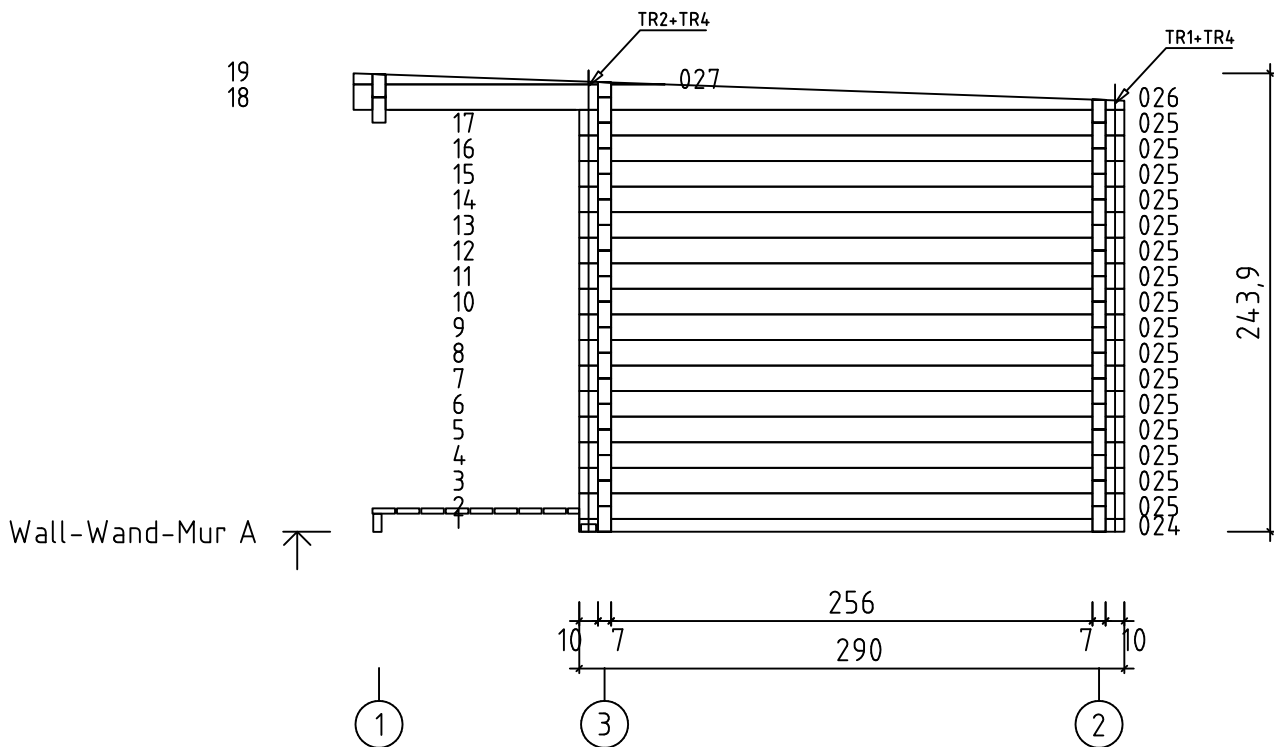

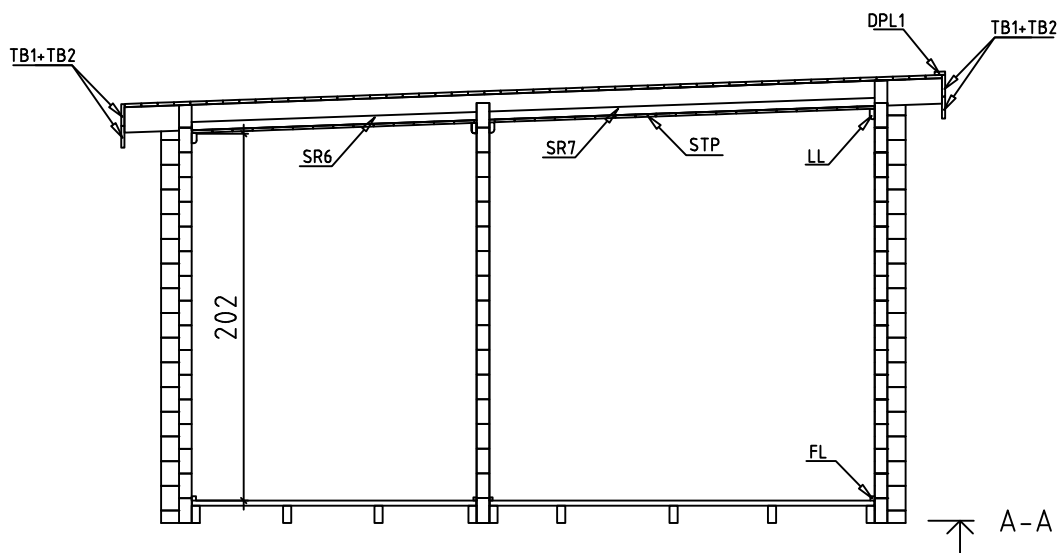
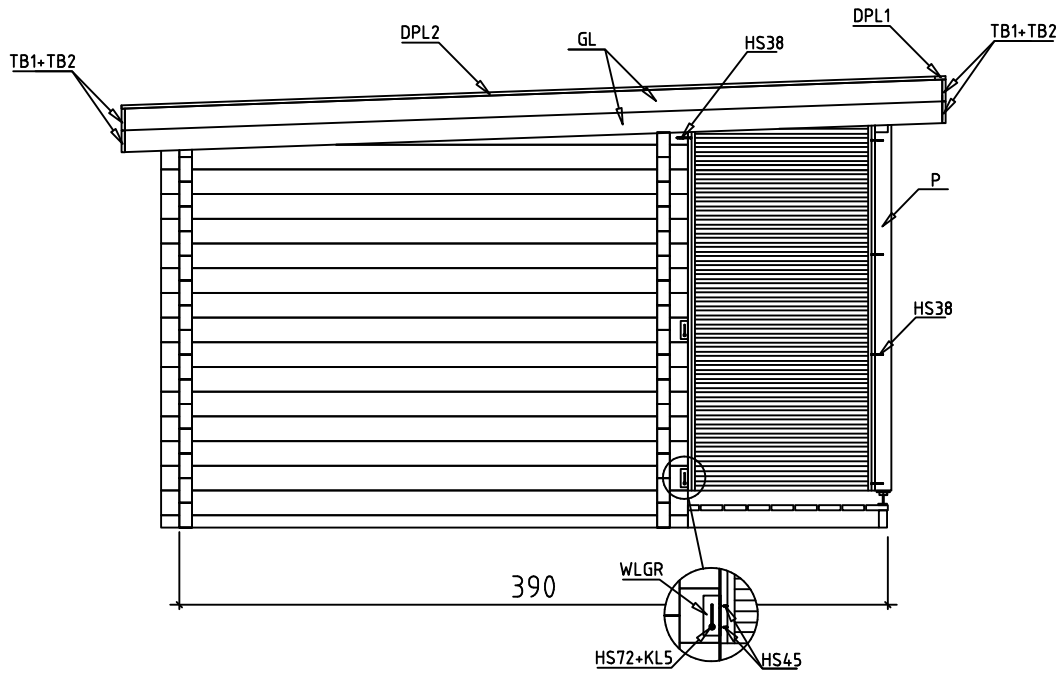
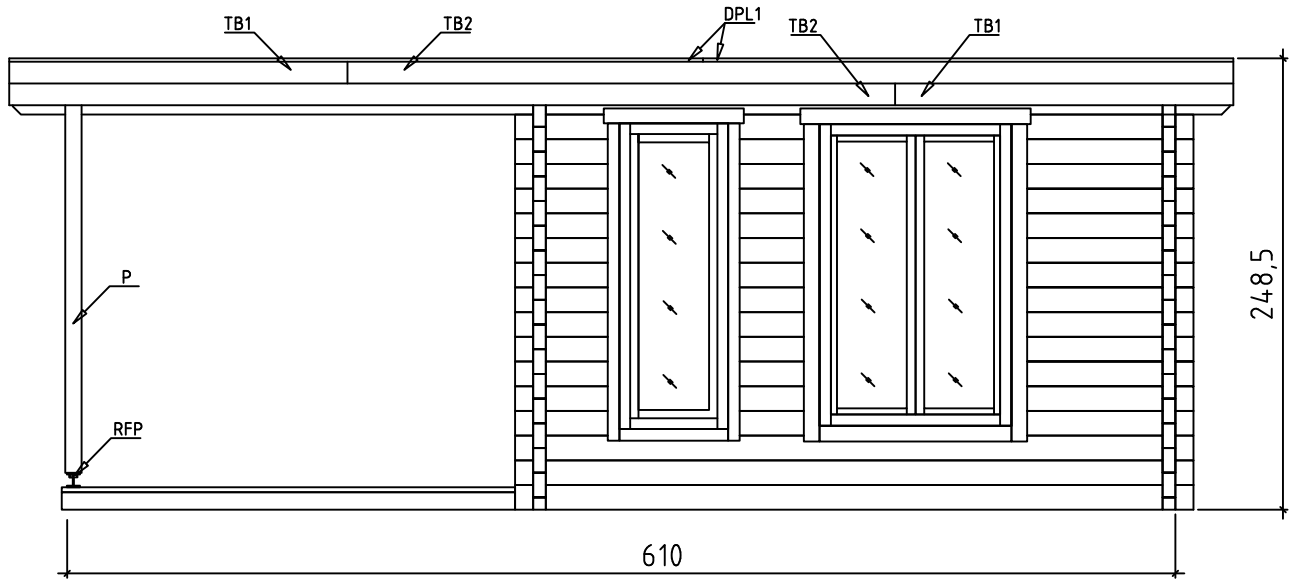

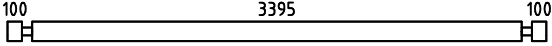

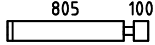
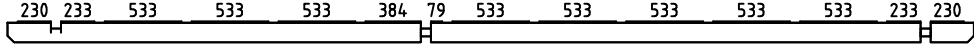
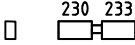
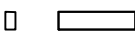
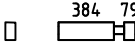
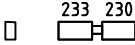
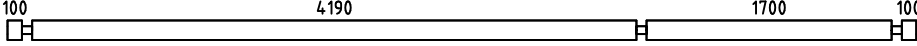
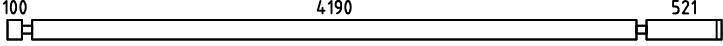
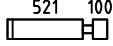
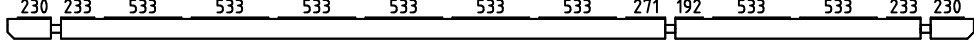
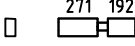
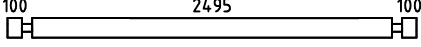
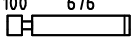

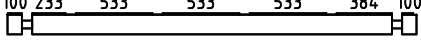
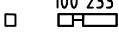
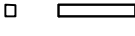
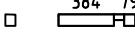
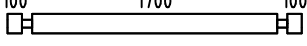
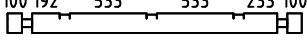
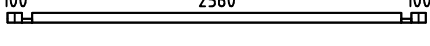
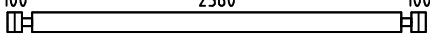



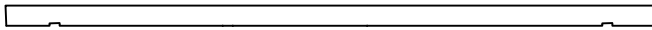
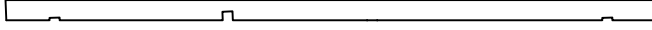
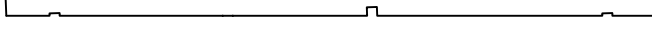

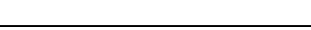
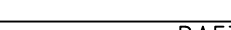
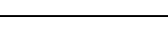

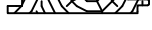
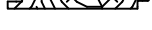
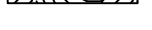

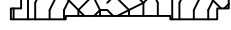
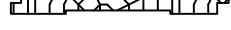
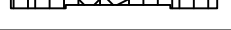
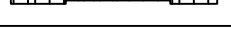
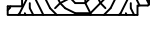
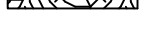

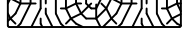









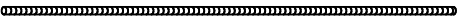









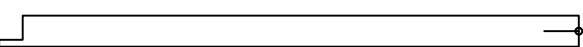
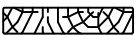
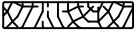

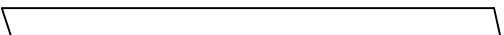

Pos	Orkney 5, Art.No.704642 Piece list - Stückliste - Liste des pieces	Q.	P (mm)	L (mm)
001		3	70x136	3735
002		13	70x136	593
003		13	70x136	495
004		13	70x136	975
005		1	70x136	6700
006		2	70x123	533
007		16	70x123	533
008		1	70x123	533
009		2	70x123	533
010		10	70x136	6300
011		5	70x136	4951
012		5	70x136	691
013		1	70x136	6700
014		1	70x123	533
015		1	70x136	2835
016		15	70x136	846
017		15	70x136	399
018		1	70x136	2835
019		1	70x81	403
020		3	70x81	533
021		1	70x81	533
022		16	70x136	2040
023		1	70x136	2040
024		1	70x68	2900
025		16	70x136	2900

Pos	Orkney 5, Art.No.704642 Piece list - Stückliste - Liste des pieces	Q.	P (mm)	L (mm)
028		1	70x68	4100
029		16	70x136	4100
032		1	70x68	1470
033		16	70x136	1470
034		1	70x136	1470
035		1	70x59	1470
036		1	70x68	1900
037		1	70x136	1900
038		13	70x136	270
039		13	70x136	793
040		1	70x136	1900
041		1	70x136	1900
042		1	70x117	1900
WA-1		1		
WB-1		1		
IAR7	FOUNDATION - FUNDAMENT - FONDAATION 	1	45x96	5960
IAR5	FOUNDATION - FUNDAMENT - FONDAATION 	4	45x96	4190
IAR9	FOUNDATION - FUNDAMENT - FONDAATION 	3	45x96	3395
IAR8	FOUNDATION - FUNDAMENT - FONDAATION 	1	45x96	2495
IAR10	FOUNDATION - FUNDAMENT - FONDAATION 	1	45x96	2461
IAR6	FOUNDATION - FUNDAMENT - FONDAATION 	5	45x96	1700
IAR3	FOUNDATION - FUNDAMENT - FONDAATION 	4	45x96	1151
IAR4	FOUNDATION - FUNDAMENT - FONDAATION 	1	45x96	1130
IAR1	FOUNDATION - FUNDAMENT - FONDAATION 	1	45x96	1051
IAR2	FOUNDATION - FUNDAMENT - FONDAATION 	3	45x96	150

Pos	Orkney 5, Art.No.704642 Piece list - Stückliste - Liste des pieces	Q.	P (mm)	L (mm)
SR1	RAFTER - DACHSPARREN - CHEVRON 	4	70x140	4508
SR1	RAFTER - DACHSPARREN - CHEVRON 	5	70x140	4508
SR1	RAFTER - DACHSPARREN - CHEVRON 	3	70x140	4508
SR2	RAFTER - DACHSPARREN - CHEVRON 	1	45x45	2563
SR7	RAFTER - DACHSPARREN - CHEVRON 	1	45x45	2133
SR6	RAFTER - DACHSPARREN - CHEVRON 	3	45x45	1563
SR4	RAFTER - DACHSPARREN - CHEVRON 	1	45x45	1132
SR3	RAFTER - DACHSPARREN - CHEVRON 	2	45x45	202
SR5	RAFTER - DACHSPARREN - CHEVRON 	2	45x45	202
STP	CEILING BOARDS - DECKENBRETTER - VOLIGES SOUS PLAFOND 	14	111x15	4186
STP	CEILING BOARDS - DECKENBRETTER - VOLIGES SOUS PLAFOND 	10	111x15	3882
STP	CEILING BOARDS - DECKENBRETTER - VOLIGES SOUS PLAFOND 	10	111x15	3391
STP	CEILING BOARDS - DECKENBRETTER - VOLIGES SOUS PLAFOND 	10	111x15	2074
STP	CEILING BOARDS - DECKENBRETTER - VOLIGES SOUS PLAFOND 	14	111x15	1696
PTL	FLOOR BOARDS - FUSSBODENBRETTER - LAME DE PLANCHER 	16	112x28	3756
PTL	FLOOR BOARDS - FUSSBODENBRETTER - LAME DE PLANCHER 	22	112x28	2556
PTL	FLOOR BOARDS - FUSSBODENBRETTER - LAME DE PLANCHER 	16	112x28	2126
PTL	FLOOR BOARDS - FUSSBODENBRETTER - LAME DE PLANCHER 	16	112x28	1556
	ROOF BOARDS - DACHBRETTER - VOLIGES 	50	90x18	4254
	ROOF BOARDS - DACHBRETTER - VOLIGES 	50	90x18	2446
SV2	TERRACE BOARDS - TERRASSENBRETTER - PLANCHER DE TERRASSE 	9	120x28	2565
SV2	TERRACE BOARDS - TERRASSENBRETTER - PLANCHER DE TERRASSE 	1	120x28	2495
LL	CEILING FILLET - DECKELEISTE - PROFIL DE FINITION POUR SOUS PLAFOND 		15x40	26 m.
	FLOOR FILLET-FUSSBODENLEISTE - CORNIERE DE FINITION DU PLANCHER 		18x18	26 m.
DPL1	ROOFING FELT FILLET - DACHPAPPENLEISTE - BAGUETTE DE FIXATION DU FEUTRE BITUMEUX 	2	18x58	3369

Pos	Orkney 5, Art.No.704642 Piece list - Stückliste - Liste des pieces	Q.	P (mm)	L (mm)
DPL2	ROOFING FELT FILLET - DACHPAPPENLEISTE - BAGUETTE DE FIXATION DU FEUTRE BITUMEUX 	2	18x58	4481
TR1	TREADED ROD M12 - GEWINDESTANGE M12 - TIGE FILETÉE M12 	2		325
TR2	TREADED ROD M12 - GEWINDESTANGE M12 - TIGE FILETÉE M12 	1		380
TR3	TREADED ROD M12 - GEWINDESTANGE M12 - TIGE FILETÉE M12 	2		467
TR4	TREADED ROD M12 - GEWINDESTANGE M12 TIGE FILETÉE M12 	5		2000
LPL	FIXING FILLET - FIXIRUNGSLEISTE - PROFIL DE FIXATION 	2	20x70	512
LPL	FIXING FILLET - FIXIRUNGSLEISTE - PROFIL DE FIXATION 	2	20x70	610
LPL	FIXING FILLET - FIXIRUNGSLEISTE - PROFIL DE FIXATION 	2	20x70	650
LPL	FIXING FILLET - FIXIRUNGSLEISTE - PROFIL DE FIXATION 	1	20x70	787
LPL	FIXING FILLET - FIXIRUNGSLEISTE - PROFIL DE FIXATION 	2	20x70	1060
LPL	FIXING FILLET - FIXIRUNGSLEISTE - PROFIL DE FIXATION 	1	20x70	1540
LPL	FIXING FILLET - FIXIRUNGSLEISTE - PROFIL DE FIXATION 	4	20x70	1729
LPL	FIXING FILLET - FIXIRUNGSLEISTE - PROFIL DE FIXATION 	2	20x70	1933
LPL	FIXING FILLET - FIXIRUNGSLEISTE - PROFIL DE FIXATION 	2	20x70	2000
P	POST - PFOSTEN - POTEAU 	1	90x90	2040
TB1	EAVES BOARD - TRAUFBRETT - BANDEAU DE TOIT 	4	18x120	1862
TB2	EAVES BOARD - TRAUFBRETT - BANDEAU DE TOIT 	4	18x120	4876
TBE6	FIXING FILLET FOR WINDOW - FIXIRUNGSLEISTE FÜR FENSTER - PROFIL DE FIXATION DES FENETRES 	2	28x34	650
TBE6	FIXING FILLET FOR WINDOW - FIXIRUNGSLEISTE FÜR FENSTER - PROFIL DE FIXATION DES FENETRES 	4	28x34	1729
TBE6	FIXING FILLET FOR DOOR - FIXIRUNGSLEISTE FÜR TÜR - PROFIL DE FIXATION DES PORTES 	2	28x34	1700
TBE6	FIXING FILLET FOR DOOR - FIXIRUNGSLEISTE FÜR TÜR - PROFIL DE FIXATION DES PORTES 	2	28x34	1990
GL	GABLE MOULDING - GIEBELLEISTE PLANCHE DE RIVE 	4	18x120	4504
KL4	LENGTHENING BOLT FOR TREADED ROD - VERLÄNGERUNGSMUTTER FÜR GEWINDESTANGE - MANCHON DE RACCORDEMENT DE TIGE FILETÉE 	5		
KL1	DRIVE NUT TREADED ROD - EINSHLAGMUTTER FÜR GEWINDESTANGE - ÉCROU A FRAPPER POUR TIGE FILETÉE 	5		
KL2	NUT FOR TREADED ROD - MUTTER FÜR GEWINDESTANGE - ÉCROU POUR TIGE FILETÉE 	5		

Pos	Orkney 5, Art.No.704642 Piece list - Stückliste - Liste des pieces		Q.	P (mm)	L (mm)
KL3	PLAIN WASHER TREADED ROD - UNTERLEGSCHLEIBE FÜR GEWINDESTANGE - RONDELLE PLATE POUR TIGE FILETÉE		5		
HS83	SCREW FOR FIXING FILLET - SCHRAUBEN FÜR FIXIRUNGSLEISTE - VIS POUR PROFIL DE FIXATION		75	3.5x50	
HS32	SCREW FOR EAVES BOARDS - SCHRAUBEN FÜR TRAUFBRETTER - VIS DE FIXATION POUR BANDEAU DE TOIT		104	3.5x50	
HS84	SCREW FOR FIXING FILLET - SCHRAUBEN FÜR FIXIRUNGSLEISTE - VIS POUR PROFIL DE FIXATION		46	3.5x50	
HS16	SCREW FOR GABLE MOULDING - SCHRAUBEN FÜR GIEBELLEISTE - VIS DE FIXATION POUR PLANCHE DE RIVE		48	3.5x50	
HS38	SCREW FOR FIXING TERRACE RAILING - SCHRAUBE FÜR TERRASSE VIS DE FIXATION DE GARDE-CORPS DE TERRASSE		5	4.5x80	
HS37	SCREW FOR POST - SCHRAUBEN FÜR PFOSTEN - VIS DE FIXATION DES POTEAUX		2	4.5x80	
HS45	SCREW FOR SLIDING WALL TIE - SCHRAUBEN FÜR WAND SCHIEBEREGLER IS POUR FIXATION ÉQUERRE MÉTALLIQUE AU PARAVENT		8	4x20	
NFD	SCREW FOR ROOFING FELT FILLET - SCHRAUBEN FÜR DACHPAPPEN- LEISTE - VIS POUR BAGUETTE FIXATION FEUTRE BITUMEUX		36	4x40	
	SCREW FOR GABLE - SCHRAUBEN FÜR GIEBEL - VIS POUR FIXATION DES PIGNONS		7	5x120	
HS78	SCREW FOR Pos. 019-021 - SCHRAUBEN FÜR für Pos. 019-021 VIS POUR FIXATION DERNIÈRE RANGÉE MADRIERS (Pos. 019-021)		10	5x120	
HS39	SCREW FOR FUNDAMENT - SCHRAUBEN ZUR BEFESTIGUNG FUNDAMENT - VIS POUR FONDATION		78	5x90	
HS81	SCREW FOR CEILING BOARD HOLDER - SCHRAUBE FÜR DECKENBRETTER HALTER - VIS DE FIXATION SUPPORT POUR PANNEAUX DE PLAFOND		40	5x90	
HS48	SCREW FOR Pos. 007-009; 014 - SCHRAUBEN FÜR für Pos. 007-009; 014 VIS POUR FIXATION DERNIÈRE RANGÉE MADRIERS (Pos. 007-009; 014)		44	6x180	
HS44	SCREW FOR RAFTER - SCHRAUBEN ZUR BEFESTIGUNG DACHSPARREN - VIS POUR CHEVRON		31	6x180	
HS49	SCREW FOR POST HEIGHT ADJUSTMENT - SCHRAUBEN FÜR REGULIERUNGSSCHRAUBE FÜR PFOSTEN - VIS DE FIXATION DE SUPPORT RÉGLABLE DE POTEAU		8	6x50	
HS72	SCREW FOR SLIDING WALL TIE - SCHRAUBEN FÜR WAND SCHIEBEREGLER VIS POUR FIXATION ÉQUERRE MÉTALLIQUE AU PARAVENT		2	5x60	
SH70	HAMMER BLOCK - SCHLAGHOLZ - CALLE DE FRAPPE		2		
	SCREW FOR DOORSTEP - SCHRAUBEN FÜR TÜRSCHWELLE - VIS DE FIXATION DU SEUIL DE PORTE		3	4.5x65	
NF3	ZN NAIL FOR TERRACE - ZN NÄGEL FÜR TERRASSENBRETTER - POINTE POUR PLANCHER DE TERRASSE		220	2x50	
NFF	ZN NAIL FOR FILLETS - ZN NÄGEL FÜR LEISTEN - POINTE POUR CORNIERE		104	1.4x40	
NF2	ZN NAIL FOR ROOF - ZN NÄGEL FÜR DACHBRETTER - POINTE POUR TOIT		820	2x50	
NF2	ZN NAIL FOR CEILING BOARDS - ZN NÄGEL FÜR DECKENBRETTER - CLOUS POUR VOLIGES SOUS PLAFONDS		441	2x50	
NH1	ZN NAIL FOR FLOOR - ZN NÄGEL FÜR FUSSBODENBRETTER - CLOUS POUR PLANCHER		430	2x50	
KL5	PLAIN WASHER M6 - UNTERLEGSCHLEIBE M6 - RONDELLE PLATE M6		2		

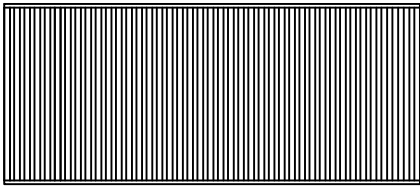
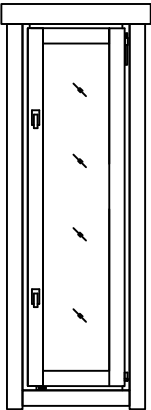
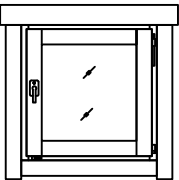
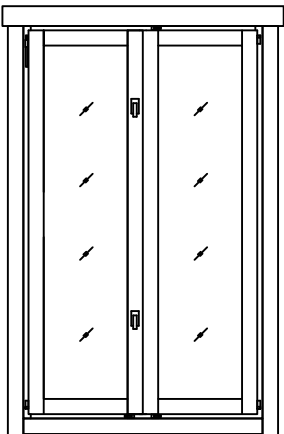
Pos	Orkney 5, Art.No.704642 Piece list - Stückliste - Liste des pieces	Q.	P (mm)	L (mm)
WLGR	SLIDING WALL TIE - SCHIEBEREGLER FÜR WAND - EQUERRE MÉTALLIQUE DE FIXATION DU PARAVENT 	2		
RFP	POST HEIGHT ADJUSTMENT - REGULIERUNGSSCHRAUBE FÜR PFOSTEN - SUPPORT RÉGLABLE DE POTEAU 	1		
	TERRACE RAILING - TERRASSE - GARDE-CORPS DE TERRASSE 	11		2040
ORZ	MONTAGE SET FOR DOORS AND WINDOWS - MONTAGE-SET FÜR TÜREN UND FENSTER - JEU DE MONTAGE PORTES ET FENETRES	1		
Prem ium A.0P.b	WINDOW-FENSTER-FENETRE 552x1729 	1		
Prem ium A.0P.c	WINDOW-FENSTER-FENETRE 650x650 	1		
Prem ium TA .0V.b	WINDOW-FENSTER-FENETRE 1100x1729 	1		

