

Padstow
Art. Nr.4422840
1/8

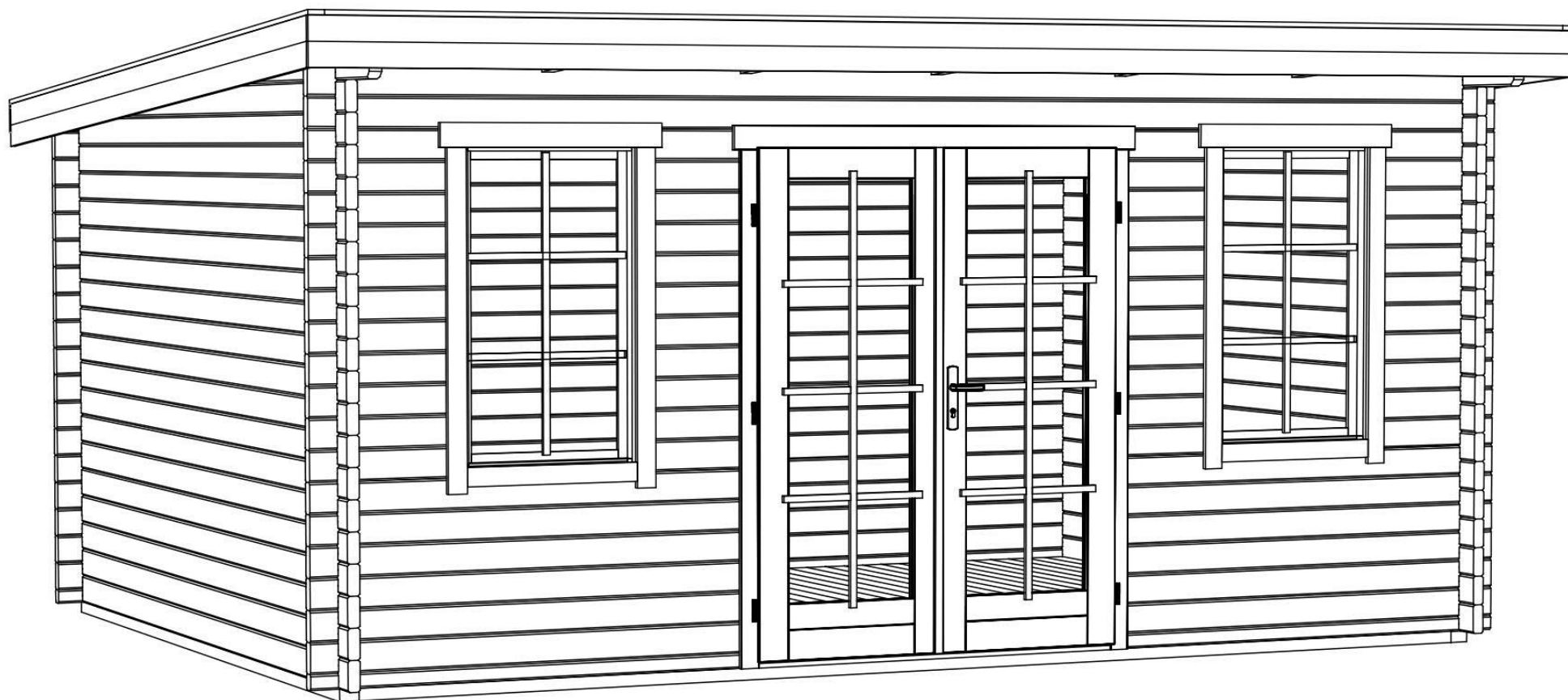

GROUNDPLAN - GRUNDPLAN - PLAN DE MASSE

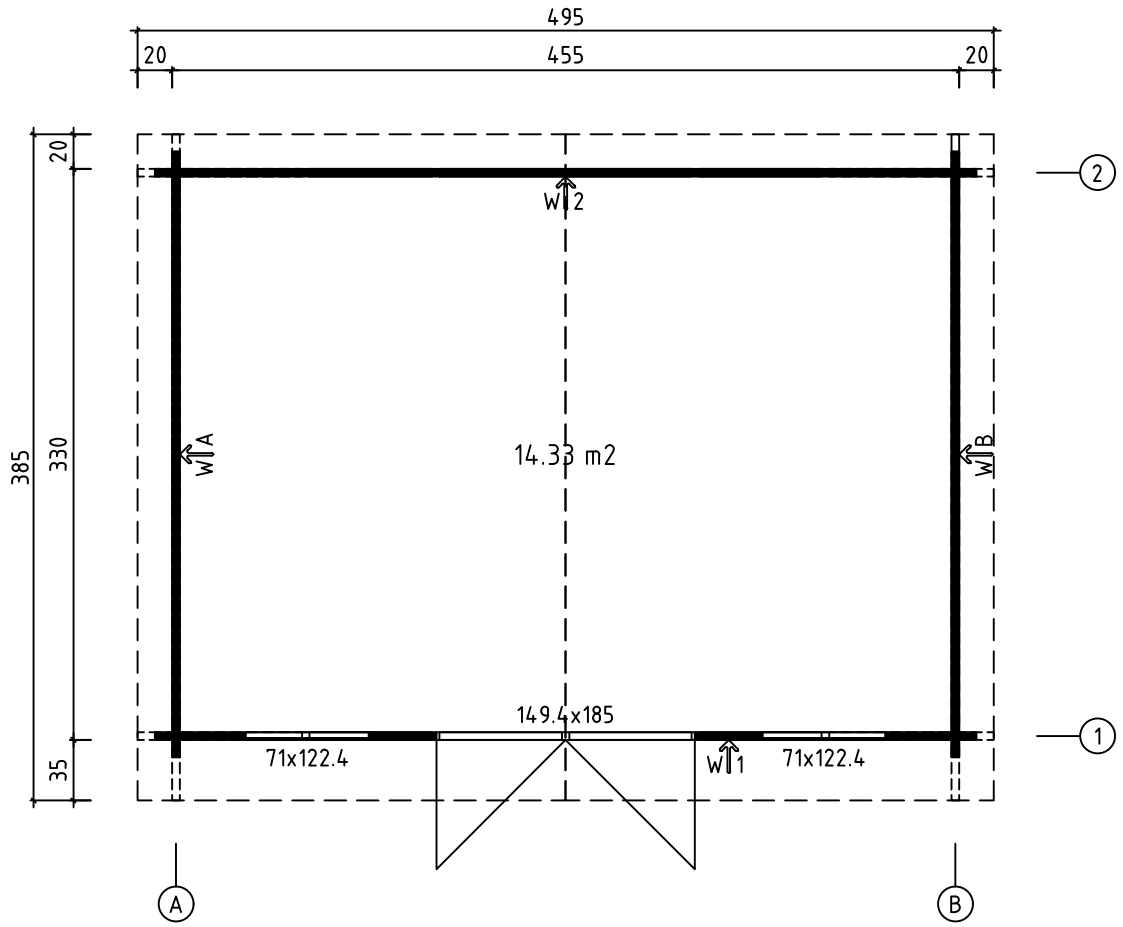

ROOF PLAN - DACH-PLAN - PLAN DU TOIT

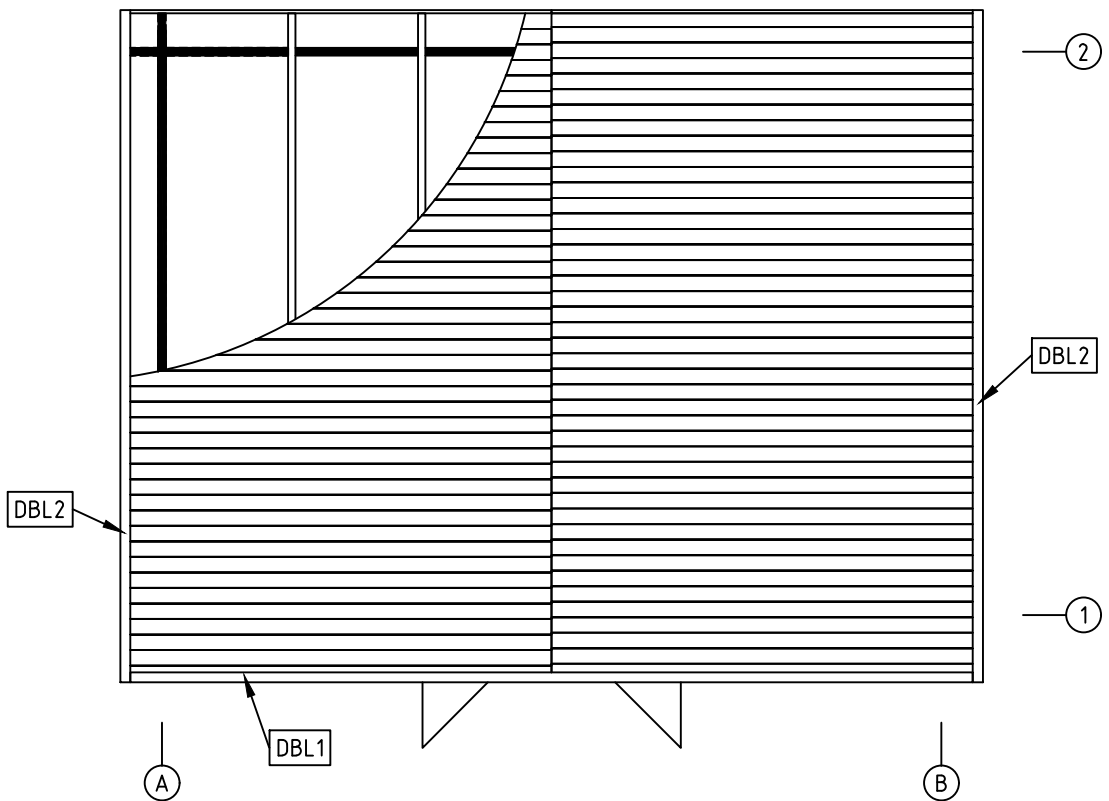

Art.Nr. 4422840

GROUNDPLAN - GRUNDPLAN - PLAN DE MASSE

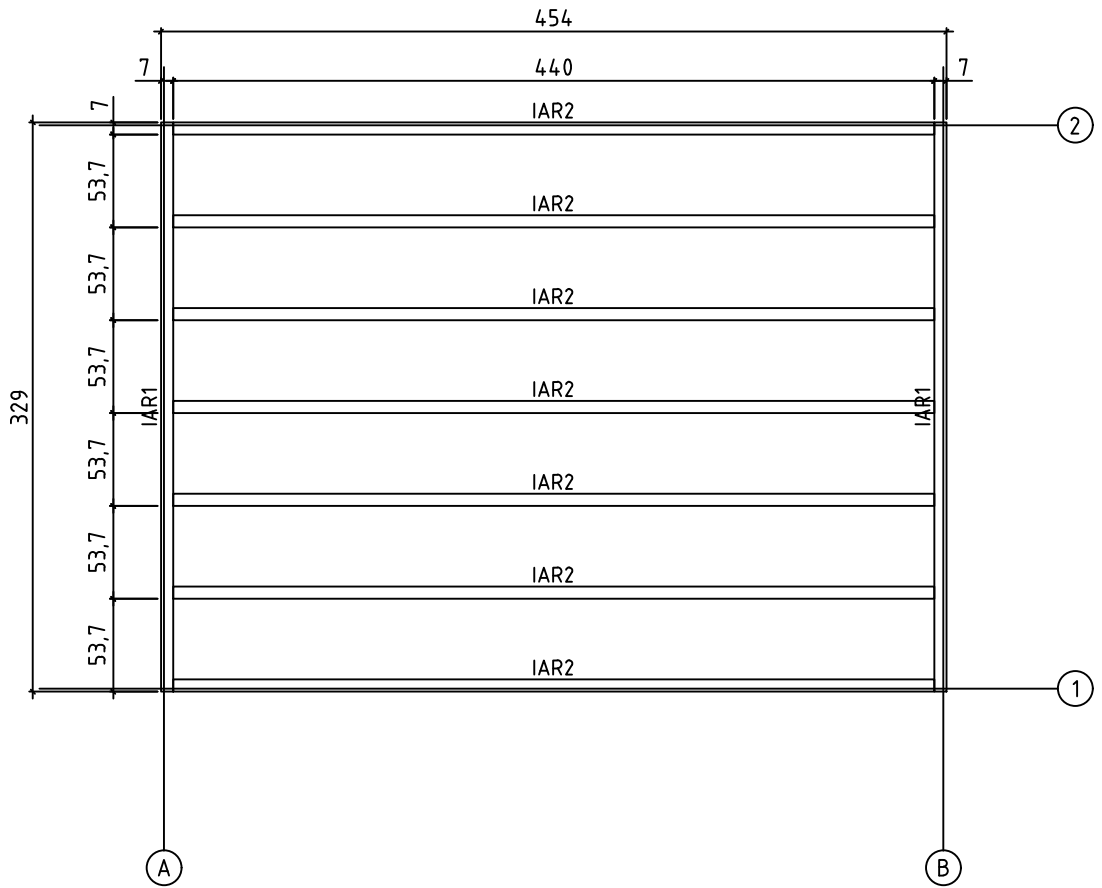

FLOOR BOARDS - FUSSBODENBRETTER - PLAN POSE
PLANCHER

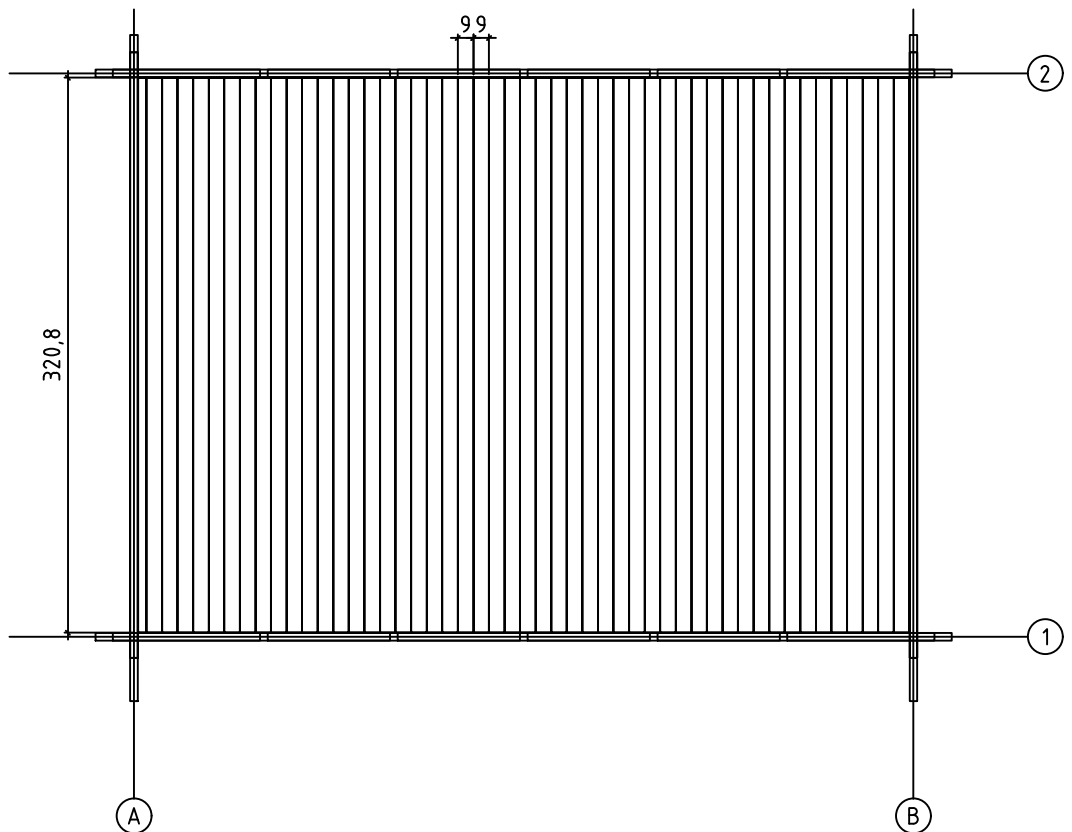

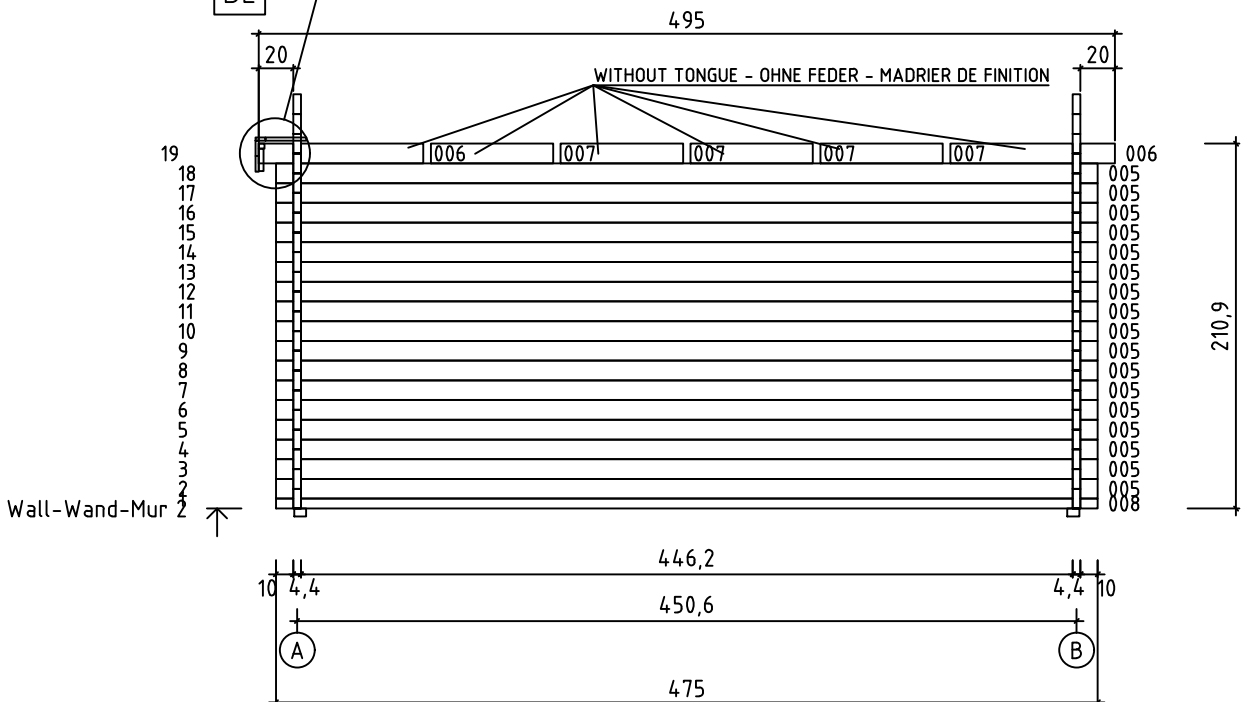
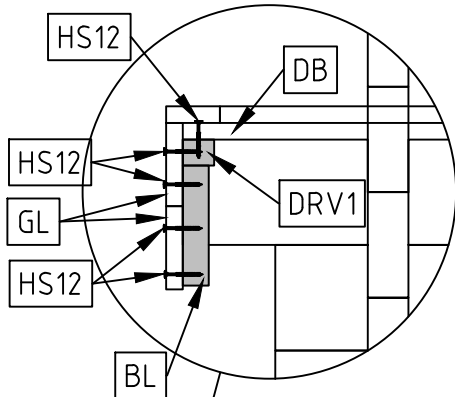
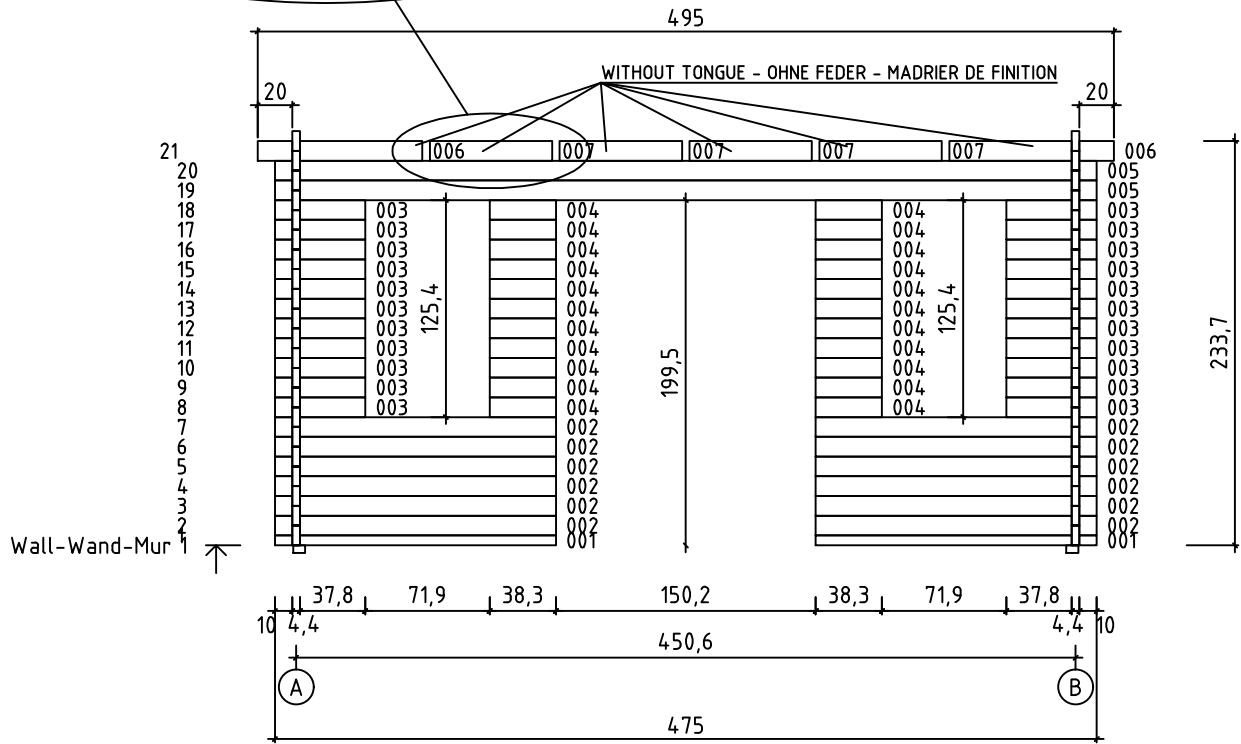
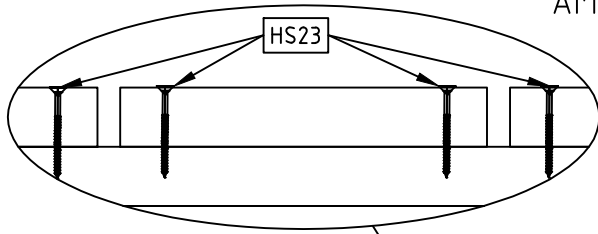

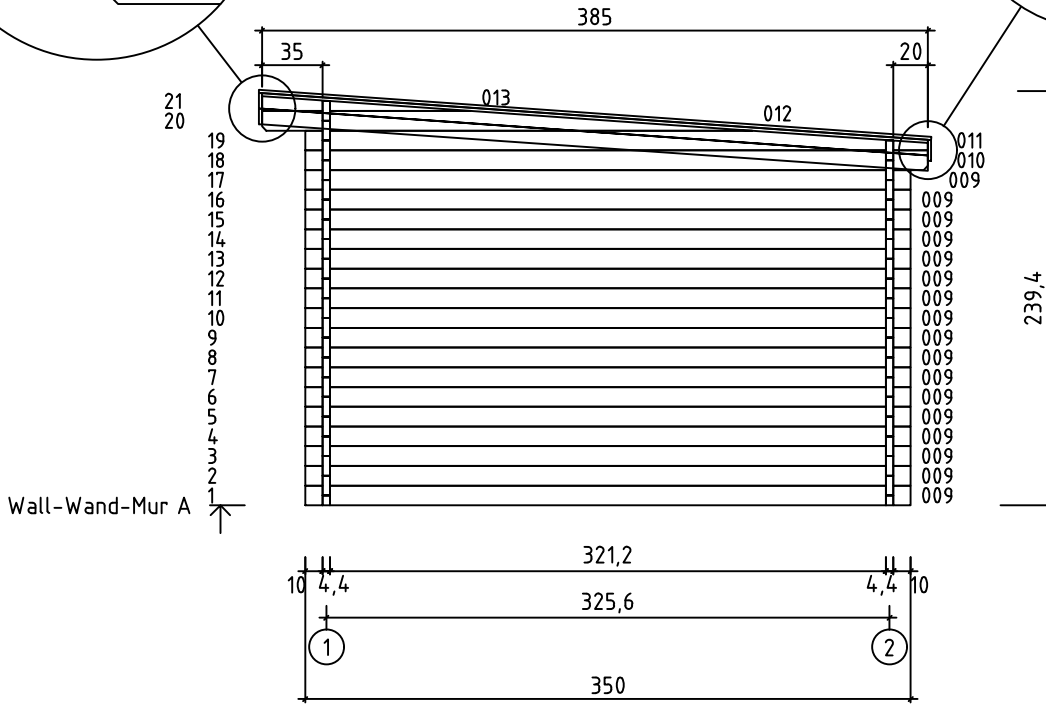
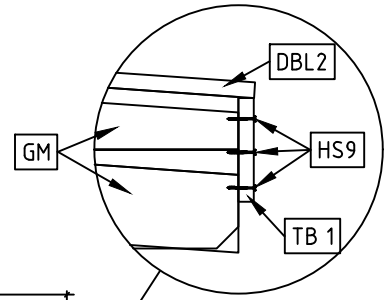
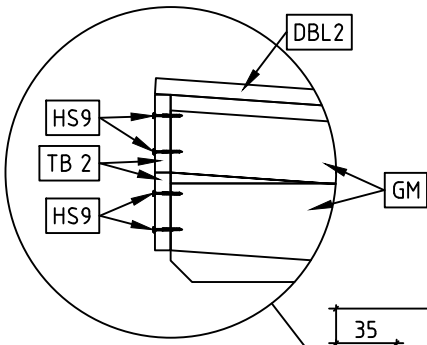



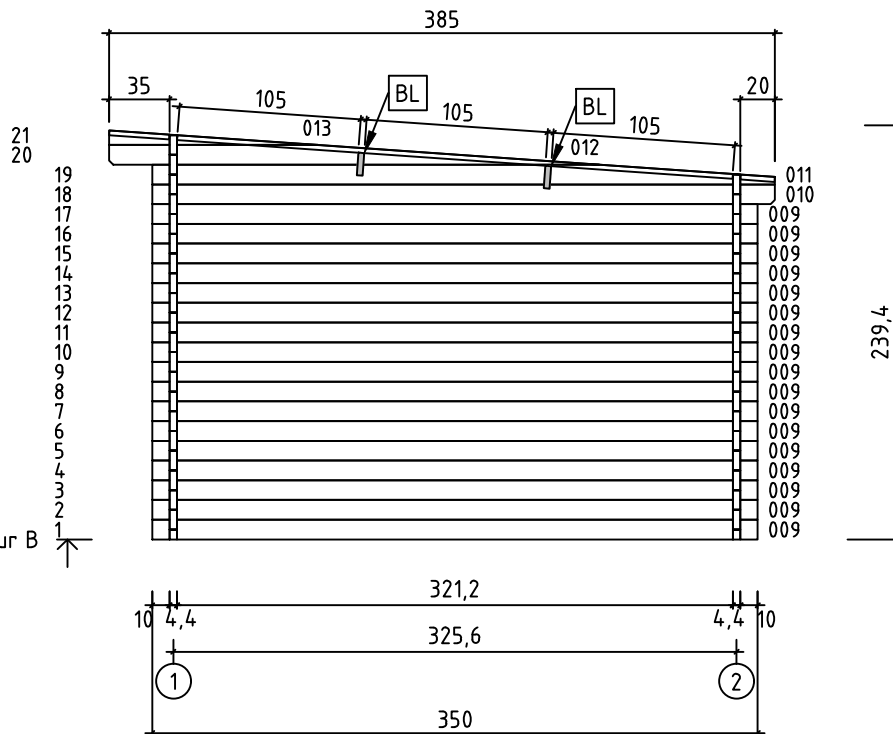



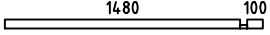
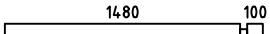

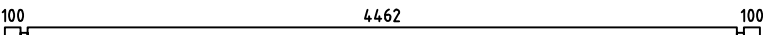
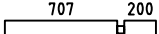
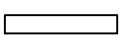
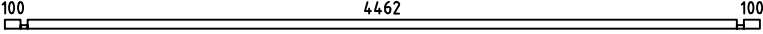
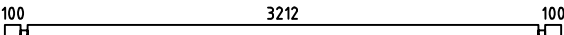
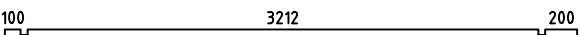
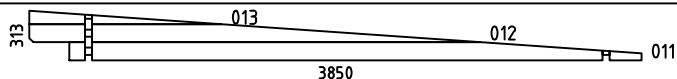
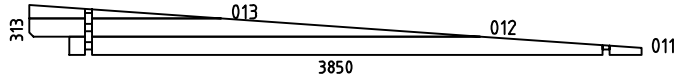
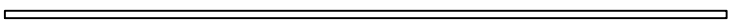

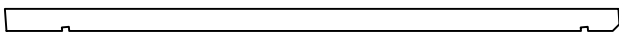
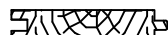
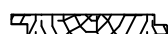

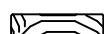
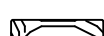
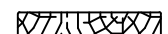
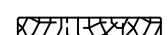





Wall-Wand-Mur A

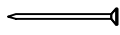
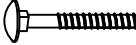

Wall-Wand-Mur B

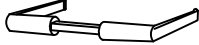
Pos	03.05.2017	Piece list - Stückliste - Liste des pièces Art.Nr. 4422840	6/8	Q	P (mm)	L (mm)
001				2	44x57	1624
002				12	44x114	1624
003				22	44x114	522
004				22	44x114	383
005				19	44x114	4750
006				4	44x114	951
007				8	44x114	707
008				1	44x57	4750
009				34	44x114	3500
010				2	44x114	3600
WA-1				1		
WB-1				1		
		FOUNDATION - FUNDAMENT - FONDATION				
IAR2				7	70x45	4400
		FOUNDATION - FUNDAMENT - FONDATION				
IAR1				2	70x45	3290
		RAFTER - DACHSPARREN - CHEVRON				
SR1				5	44x140	3866
		FLOOR BOARDS - FUSSBODENBRETTER - LAME DE PLANCHER		50	90x18	3208
DB		ROOF BOARDS - DACHBRETTER - VOLIGES		86	90x18	2475
		FLOOR FILLET - FUSSBODENLEISTE - CORNIERE DE FINITION DU PLANCHER			18x18	15.33
DBL 2		ROOFING FELT FILLET - DACHPAPPENLEISTE - BAGUETTE DE FIXATION DU FEUTRE BITUMEUX		2	18x58	3896
DBL 1		ROOFING FELT FILLET - DACHPAPPENLEISTE - BAGUETTE DE FIXATION DU FEUTRE BITUMEUX		1	18x58	4870
TB 1		FASCIA BOARD - TRAUFBRETT - BANDEAU DE TOIT		2	18x120	2493
TB 2		FASCIA BOARD - TRAUFBRETT - BANDEAU DE TOIT		2	18x90	4986
DRV 1		ROOF EDGE REINFORCEMENT - DACHRANDVERSTÄRKUNG - CORNIERE DE RENFORT DE BORD DE TOIT		2	28x34	198
DRV 2		ROOF EDGE REINFORCEMENT - DACHRANDVERSTÄRKUNG - CORNIERE DE RENFORT DE BORD DE TOIT		2	28x34	349
DRV 3		ROOF EDGE REINFORCEMENT - DACHRANDVERSTÄRKUNG - CORNIERE DE RENFORT DE BORD DE TOIT		2	28x34	3218

Pos	03.05.2017	Piece list - Stückliste - Liste des pièces Art.Nr. 4422840	7/8	Q	P (mm)	L (mm)
KFS 1		STORM PROTECTION - STURMLEISTE - LATTE ANTI-TEMPETE 		2	22x45	2050
KFS 2		STORM PROTECTION - STURMLEISTE - LATTE ANTI-TEMPETE 		2	22x45	2500
BL		FIXING SLAT FOR DISTANCE SPACERS - BEFESTIGUNGSLEISTE - RENFORTS PLANCHES DE RIVES 		4	28x34	130
GM		GABLE MOULDING - GIEBELLEISTE - PLANCHE DE RIVE 		4	18x90	3866
FS2		WINDOW HANDLE FITTINGS - FENSTERGRIFF - POIGNEE DE FENETRE 		1		
HS1		SCREW FOR GEORGIAN BARS - SCHRAUBE FÜR SPROSSEN - VIS POUR CROISILLONS 		14	2.5x20	
HS1		SCREW FOR GEORGIAN BARS - SCHRAUBE FÜR SPROSSEN - VIS POUR CROISILLONS 		16	2.5x20	
HS8		SCREW FOR GABLE SEGMENT - SCHRAUBEN FÜR DECKBLATT - VIS POUR FIXATION LOSANGE DE FINITION 		4	3.5x35	
HS9		SCREW FOR FASCIA BOARDS - SCHRAUBEN FÜR TRAUFBRETTER - VIS POUR FIXATION BANDEAU DE TOIT 		56	3.5x50	
HS4		SCREW FOR DOOR FILLET - SCHRAUBE ZUR BEFESTIGUNG TÜRLEISTE - VIS POUR FIXATION BAGUETTE D'ARRET DE PORTE 		5	3x30	
HS12		SCREW FOR ROOF EDGE REINFORCEMENT - SCHRAUBEN FÜR DACHRANDVERSTÄRKUNG - VIS POUR FIXATION CORNIERE RENFORT DE BORD DE TOIT 		22	4x40	
HS12		SCREW FOR DISTANCE SPACER FIXING SLAT - SCHRAUBEN FÜR BEFESTIGUNGS - LEISTE - VIS DE FIXATION RENFORTS PLANCHES DE RIVES 		16	4x40	
HS12		SCREW FOR GABLE MOULDING - SCHRAUBEN FÜR GIEBELLEISTE - VIS POUR FIXATION PLANCHE DE RIVE 		32	4x40	
HS18		SCREW FOR FOUNDATION - SCHRAUBEN ZUR BEFESTIGUNG FUNDAMENT - VIS DE FIXATIONS DES POUTRELLES DE FONDATIONS 		14	5x120	
HS18		SCREW FOR GABLE - SCHRAUBEN FÜR GIEBEL - VIS POUR FIXATION DES PIGNONS 		12	5x120	
HS18		SCREW FOR ROOF BEAMS - SCHRAUBEN FÜR DACHBALKEN - VIS POUR FIXATION PANNES DE TOIT 		10	5x120	
HS16		SCREW FOR 1. WALL BEAM - SCHRAUBE FÜR 1. BOHLENREIHE - VIS DE FIXATIONS 1ere RANGÉE DE MADRIERS AVEC POUTRELLES DE FONDATIONS 		8	5x90	
HS16		SCREW FOR DOOR JAMB - SCHRAUBE FÜR TÜRRAHMEN - VIS DE FIXATION PARTIE HAUTE AVEC MONTANTS DU CADRE DE PORTE 		4	5x90	
HS23		SCREW FOR WALL DETAILS (006; 007) - SCHRAUBE FÜR WAND DETAILS - VIS POUR MUR DETAILS 		20	6x180	
HS25		SCREW FOR DOORSTEP - SCHRAUBEN FÜR SWELLE - VIS POUR FIXATION BARRE DE SEUIL 		3	4.5x65	
NF2		ZN NAIL FOR FLOOR FILLET - ZN NÄGEL FÜR FUSSBODENLEISTE - POINTE POUR CORNIERE DE FINITION DU PLANCHER 		32	1.4x40	
SH44		HAMMER BLOCK - SCHLAGHOLZ - CALLE DE FRAPPE 		1		
SFS		NUT FOR STORM PROTECTION - SCHRAUBENMUTTER FÜR STURMLEISTE - ECROU POUR LATTE ANTI-TEMPETE 		8	D8	
NF4		ZN NAIL FOR ROOF - ZN NÄGEL FÜR DACHBRETTER - POINTE POUR FIXATION VOLIGES DE TOIT 		364	2x50	
NF4		ZN NAIL FOR FLOOR - ZN NÄGEL FÜR FUSSBODENBRETTER - CLOUS POUR PLANCHER 		357	2x50	

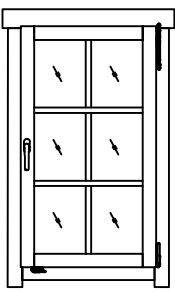
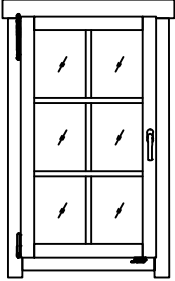
Pos	03.05.2017	Piece list - Stückliste - Liste des pièces Art.Nr. 4422840	8/8	Q	P (mm)	L (mm)
NF5		ZN NAIL FOR ROOFING FELT FILLET - ZN NÄGEL FÜR DACHPAPPENLEISTE - POINTE POUR BAGUETTE DE FIXATION FEUTRE BITUMEUX		29	2x40	
BFS		BOLT FOR STORM PROTECTION - BOLZEN FÜR STURMLEISTE - BOULON POUR LATTE ANTI-TEMPETE		8	8x80	
MH		MALE BOLT HINGE FOR DOOR - TÜRBAND - PARTIE MALE DE PAUMELLE DE PORTE		6		
HC		COVERS FOR DOOR HINGES - SCHUTZKAPPE FÜR TÜRBAND - COUVERTURE DE PAUMELLE DE PORTE		12	D8	
DFS		WASHER FOR STORM PROTECTION - DICHTSCHEIBE FÜR STURMLEISTE - RONDELLE POUR LATTE ANTI-TEMPETE		8		
TL4		DOOR HANDLE FITTINGS - TÜRGRIF - POIGNEE DE PORTE		1		
TL5		SET OF DOOR LOCK COVERS - SCHLOSSBLENDEN - SET DE GARNITURES DE PORTE		1		
		CYLINDER LOCK - ZYLINDERSCHLOSS - BARILLET DE PORTE		1		
		STRIKER FOR BARREL BOLT - HÜLSE FÜR GRENDRIEGEL - GACHE AU SOL DU TARGETTE		2		
		WINDOW - FENSTER - FENETRE 710x1224		1		
			AK.1.106.PSP DGP+			
						
		WINDOW - FENSTER - FENETRE 710x1224		1		
			AK.1.106.PSV DGP+			
						
		DOOR - TÜR - PORTE 1494x1957		1		
			TUK.1.108.PVP.MMb DGP+			
		