

TIROL 44
Art.No. 4420202

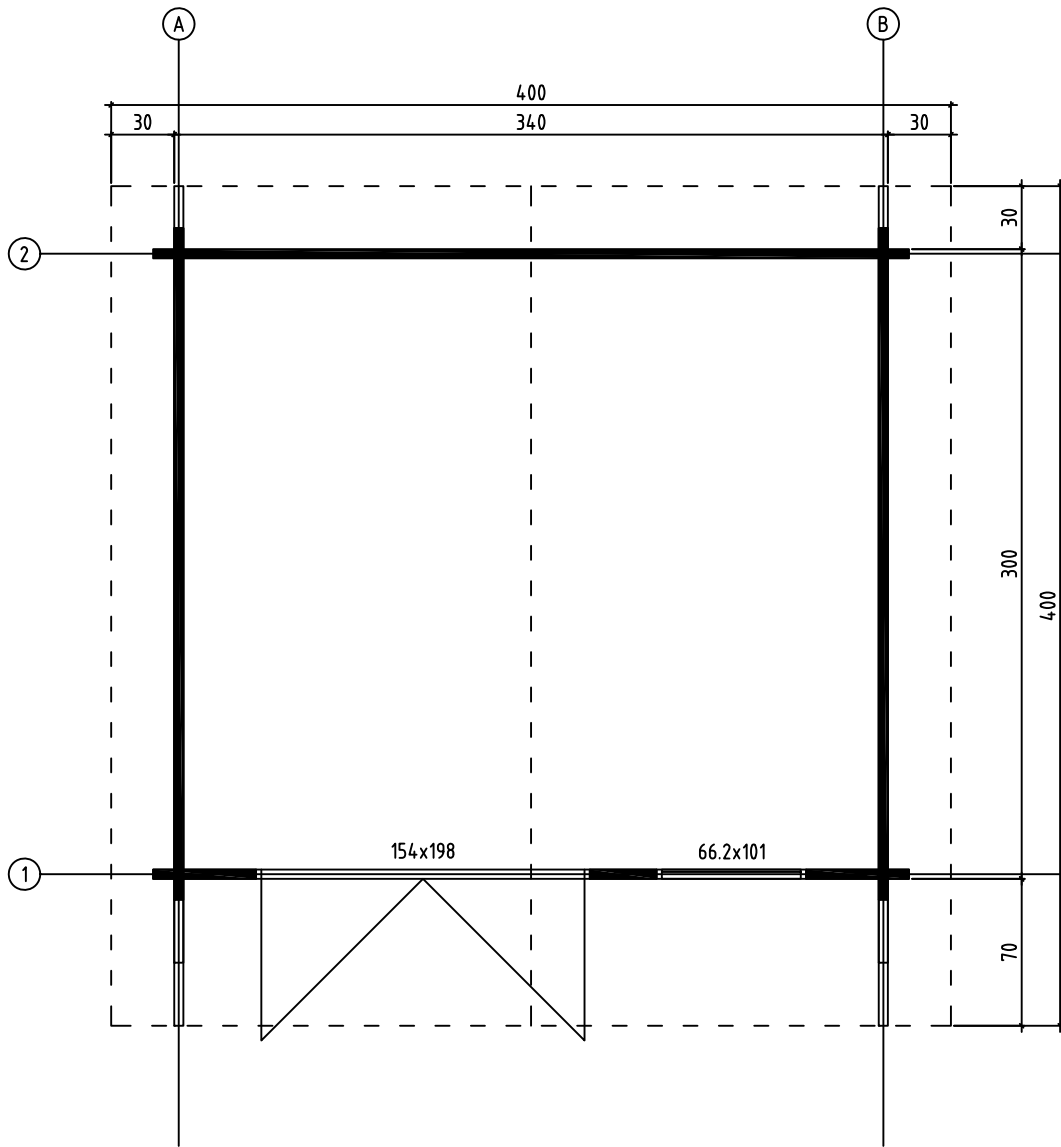

TIROL 44, Art.No.4420202
GRUNDPLAN



TIROL 44, Art.No.4420202
FUNDAMENT

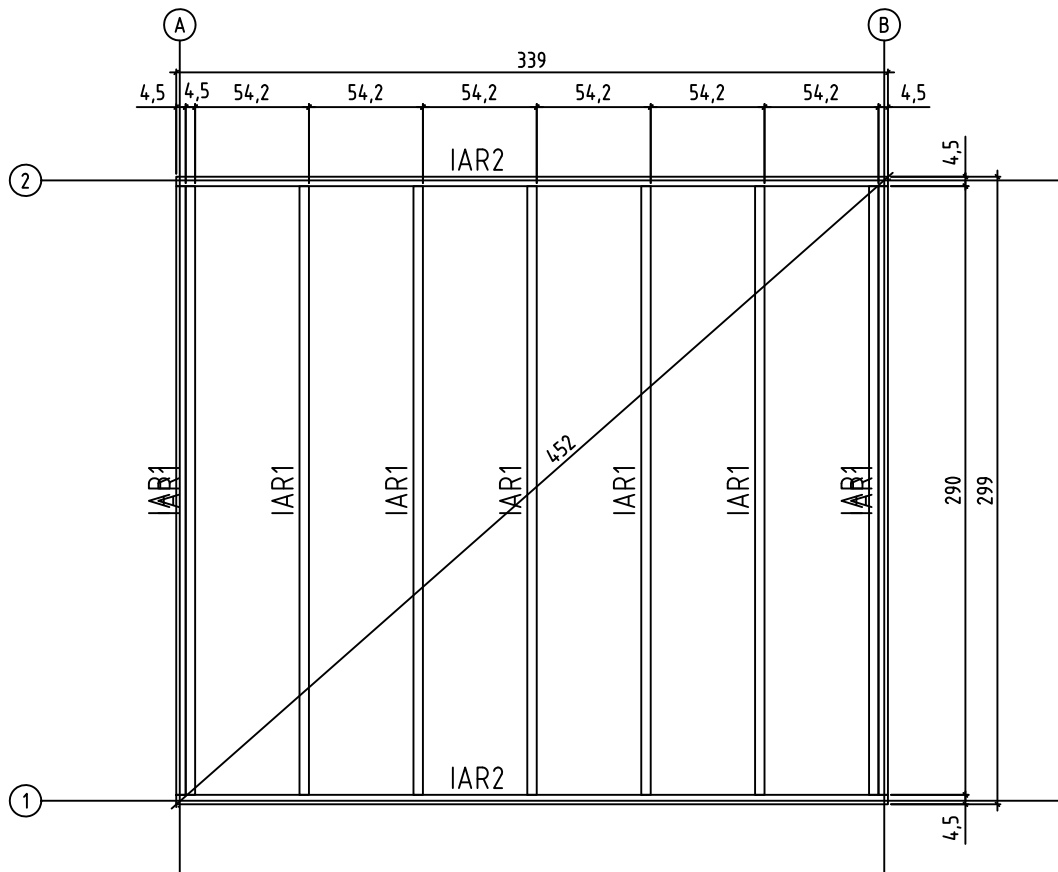



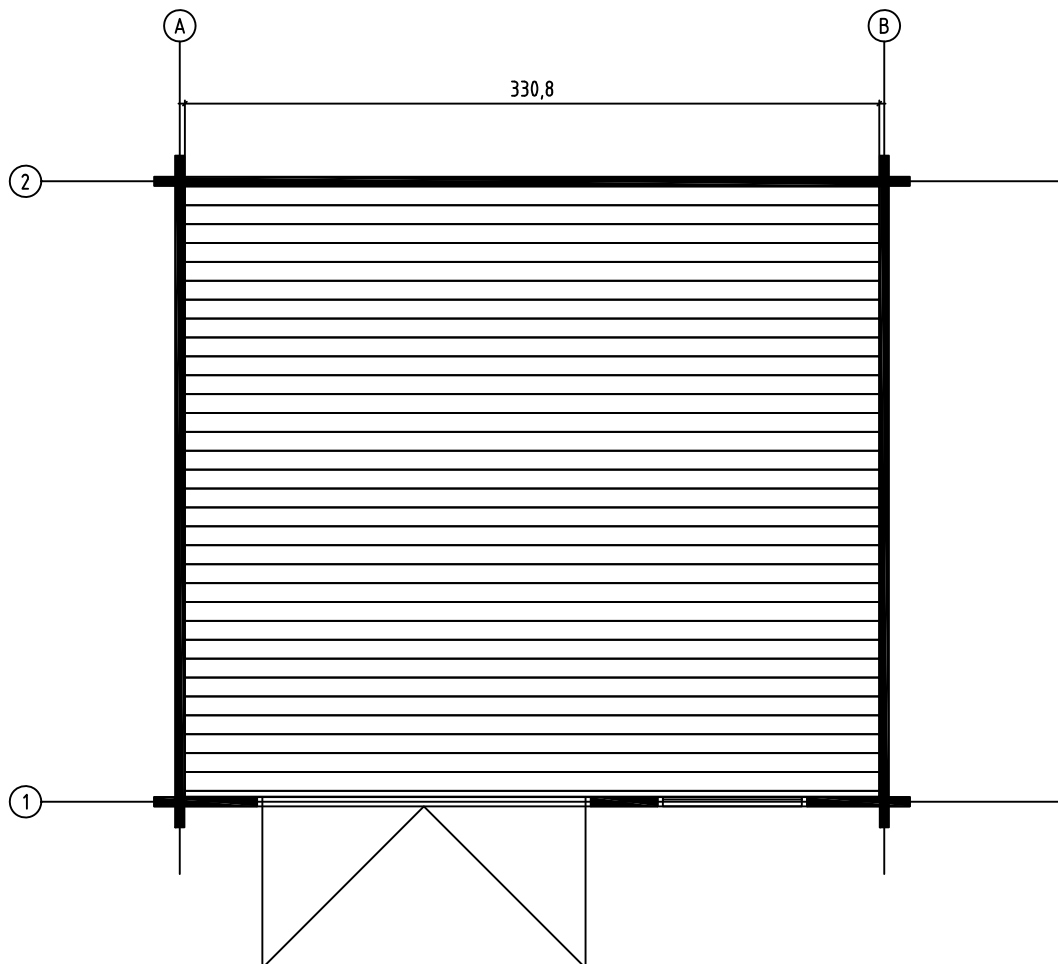

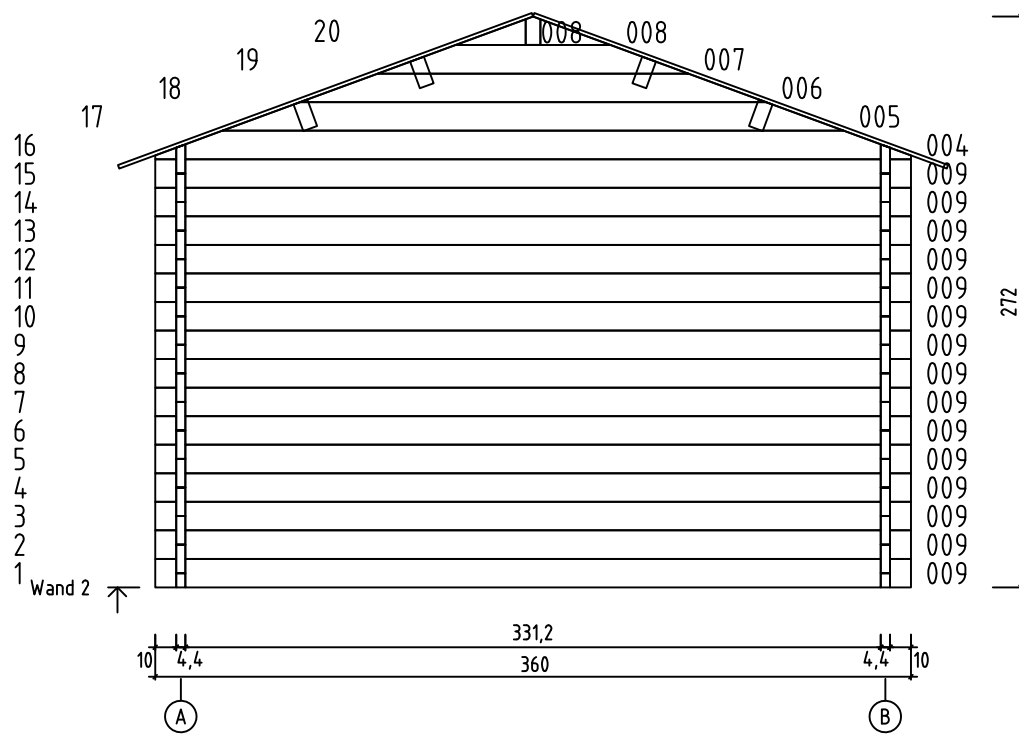
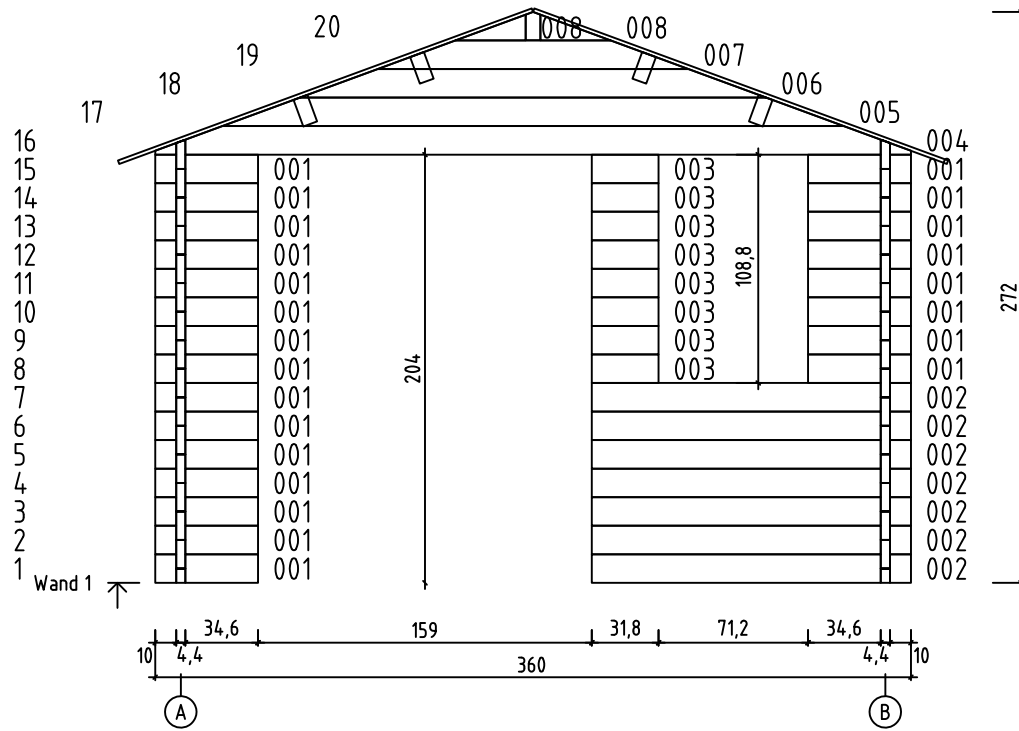

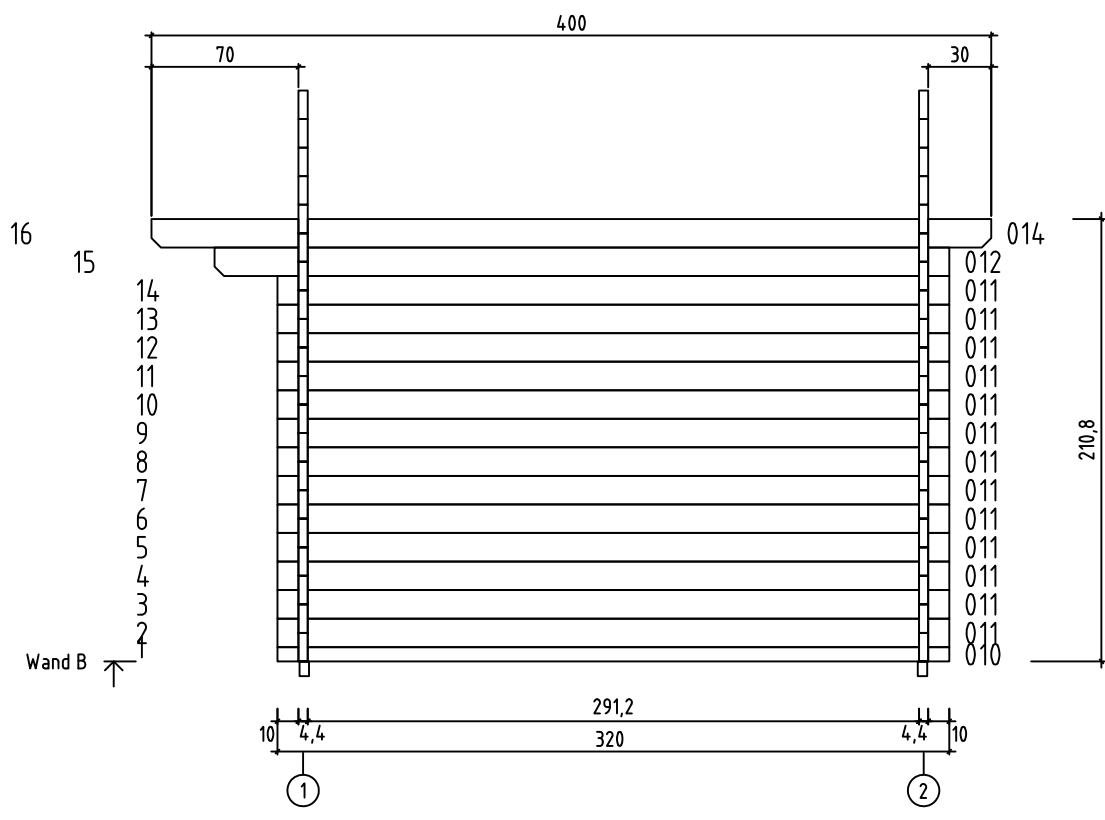
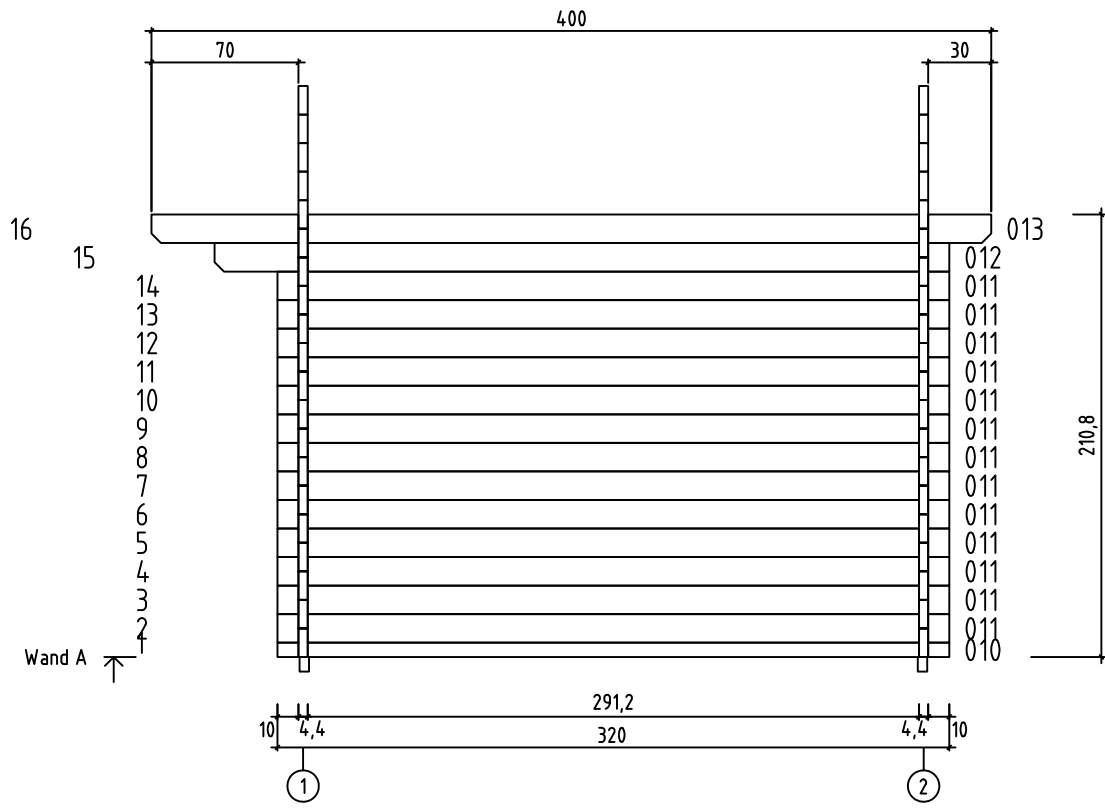

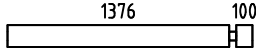

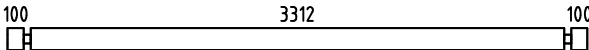
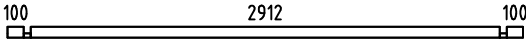
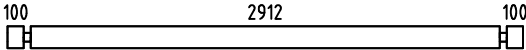
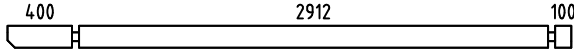
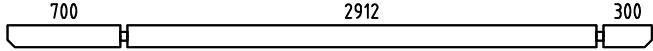
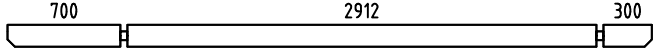
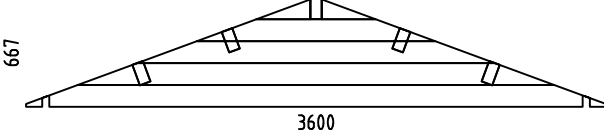
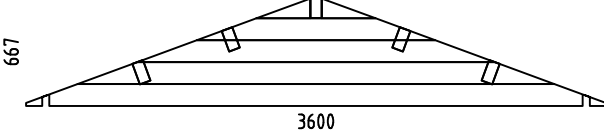
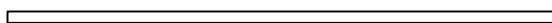
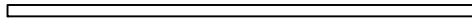
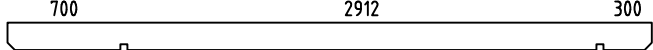
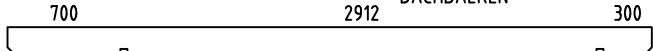
FUSSBODENBRETTER











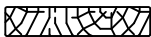

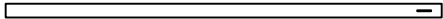

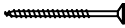

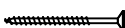









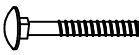

Pos	TIROL 44, Art.No.4420202 Stückliste	Q.	P (mm)	L (mm)
001		23	44x136	490
002		7	44x136	1520
003		8	44x136	318
009		15	44x136	3600
010		2	44x68	3200
011		26	44x136	3200
012		2	44x136	3500
013		1	44x136	4000
014		1	44x136	4000
W1-1		1		
W2-1		1		
IAR2	FUNDAMENT 	2	45x70	3390
IAR1	FUNDAMENT 	9	45x70	2900
PR1	DACHBALKEN 	1	70x170	4000
A-PR1	DACHBALKEN 	4	70x170	4000
	FUSSBODENBRETTER 	33	90x18	3308
	DACHBRETTER 	90	90x18	2100
	FUSSBODENLEISTE 		15x40	12.4 m.
DPL	DACHPAPPENLEISTE 	4	18x58	2150
LPL	FIXIRUNGSLEISTE 	2	20x45	662
LPL	FIXIRUNGSLEISTE 	2	20x45	1050
LPL	FIXIRUNGSLEISTE 	1	20x45	1540
LPL	FIXIRUNGSLEISTE 	2	20x45	2000

TIROL 44, Art.No.4420202
Stückliste

Pos			Q.	P (mm)	L (mm)
TB	TRAUFBRETT		2	18x90	4000
DRV	DACHRANDVERSTÄRKUNG		2	28x34	4000
KFS	STURMLEISTE		4	22x45	2015
GL	GIEBELLEISTE		4	18x120	2150
HS12	SCHRAUBEN FÜR DECKBLATT		4	3.5x35	
HS83	SCHRAUBEN FÜR FIXIRUNGSLEISTE		29	3.5x50	
HS16	SCHRAUBEN FÜR GIEBELLEISTE		32	3.5x50	
HS32	SCHRAUBEN FÜR TRAUFBRETT		18	4x40	
HS26	SCHRAUBEN FÜR DACHRANDVERSTÄRKUNG		18	4x40	
HS40	SCHRAUBE FÜR 1. BOHLENREIHE		8	5x120	
HS42	SCHRAUBEN FÜR GIEBEL		20	5x120	
HS43	SCHRAUBEN FÜR DACHBALKEN		10	5x120	
HS39	SCHRAUBEN ZUR BEFESTIGUNG FUNDAMENT		26	5x90	
SH44	SCHLAGHOLZ		1		
NFD	ZN NÄGEL FÜR DACHPAPPENLEISTE		20	2x40	
NFF	ZN NÄGEL FÜR LEISTEN		25	1.4x40	
NF2	ZN NÄGEL FÜR DACHBRETT		380	2x50	
NH1	ZN NÄGEL FÜR FUSSBODENBRETT		238	2x50	
GS	DECKBLATT		2		
SFS	SCHRAUBENMUTTER FÜR STURMLEISTE		8		
BFS	BOLZEN FÜR STURMLEISTE		8		
DFS	DICHTSCHEIBE FÜR STURMLEISTE		8		

TIROL 44, Art.No.4420202
Stückliste

Pos

Q.

P
(mm)

L
(mm)

FENSTER 702x1050

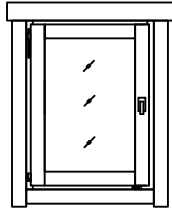

1

Premium
A.0V.e

TÜR 1580x2000

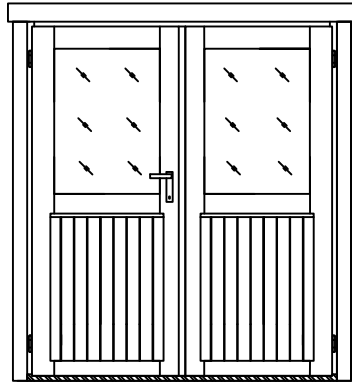

1

Premi
um TU
.20V.b

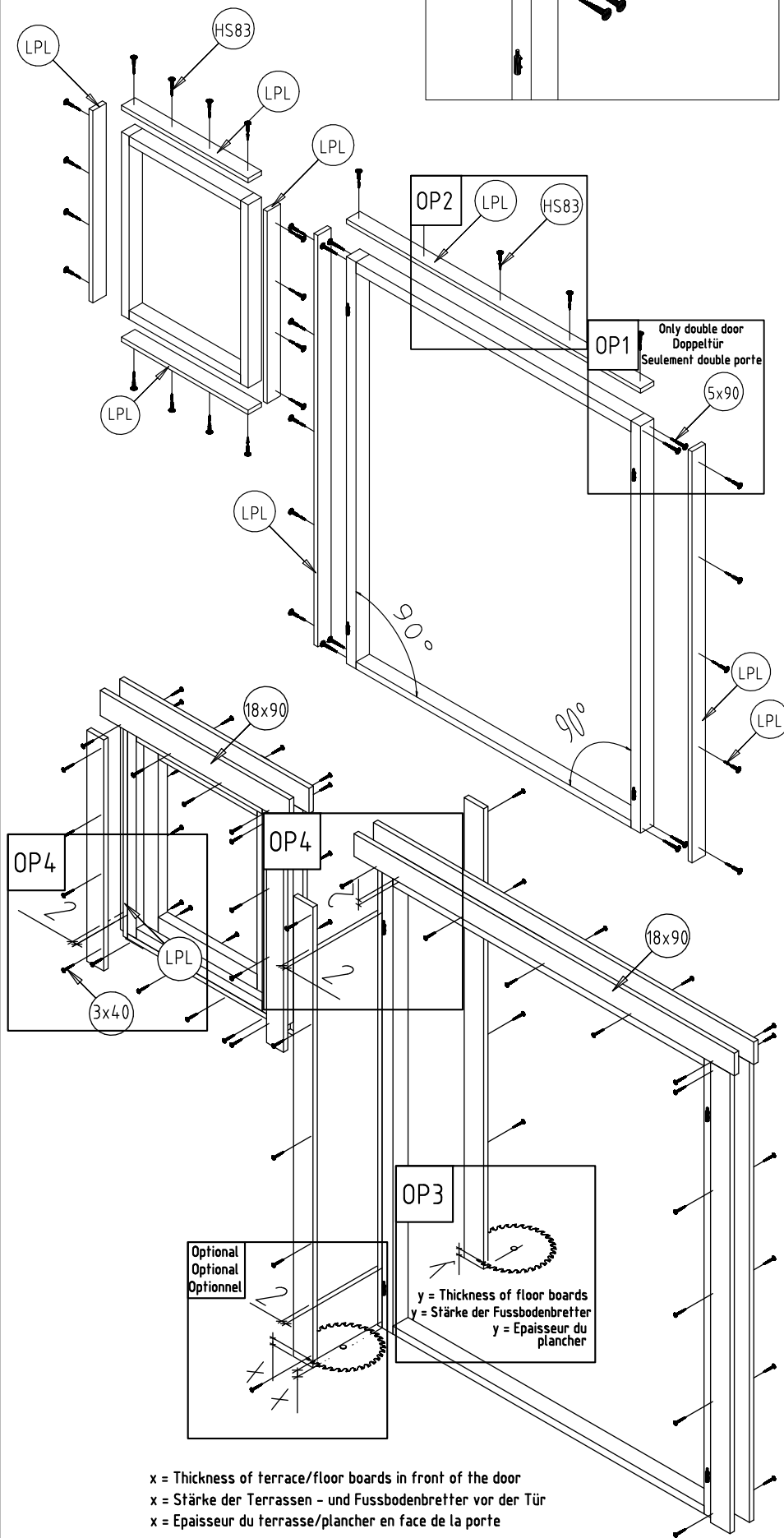
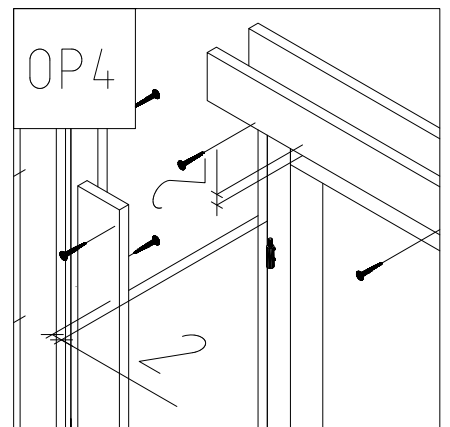
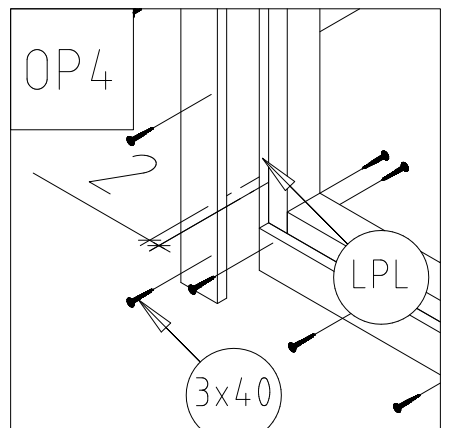
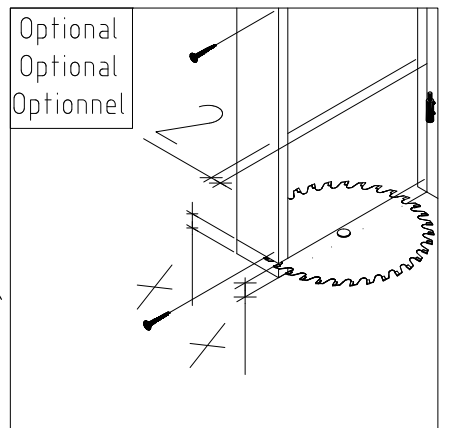
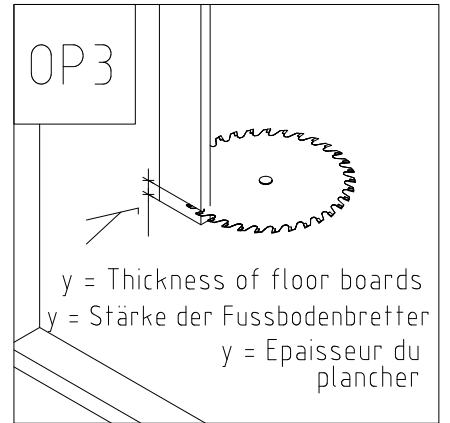
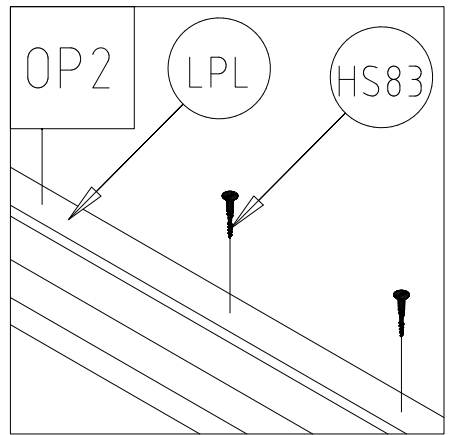
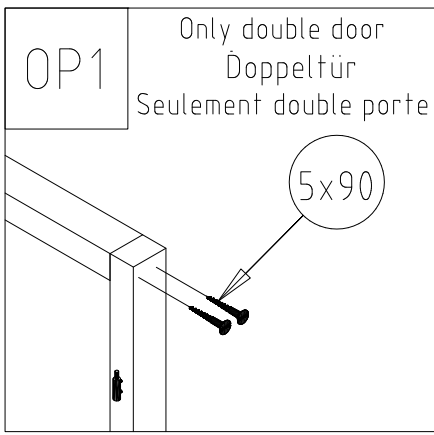

x = Thickness of terrace/floor boards in front of the door
x = Stärke der Terrassen - und Fussbodenbretter vor der Tür
x = Epaisseur du terrasse/plancher en face de la porte

