

*Windsor Mini*  
Art. Nr. 4421102  
1/11

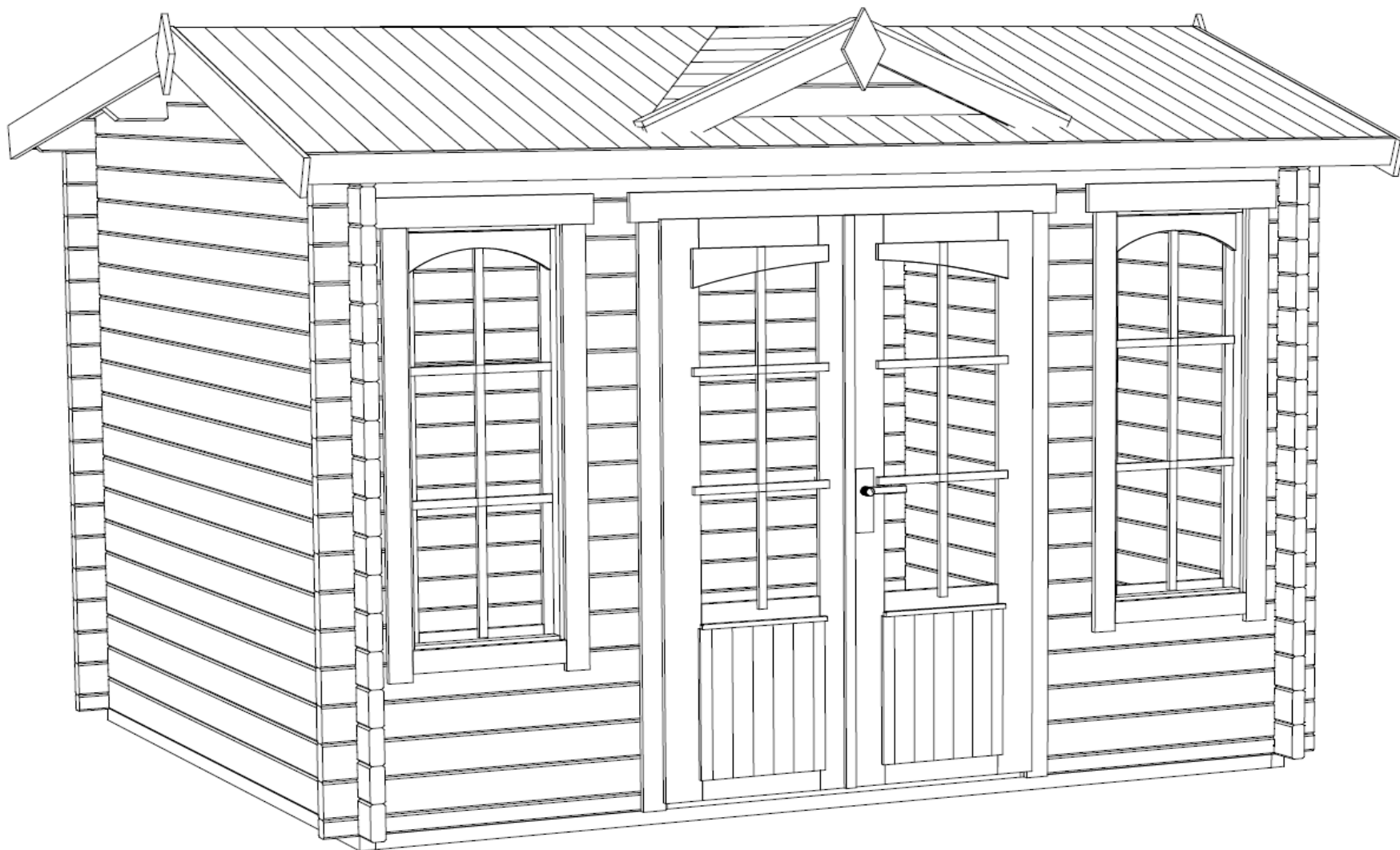

27.09.2016

Art. Nr. 4421102  
GROUNDPLAN - GRUNDPLAN - PLAN DE MASSE

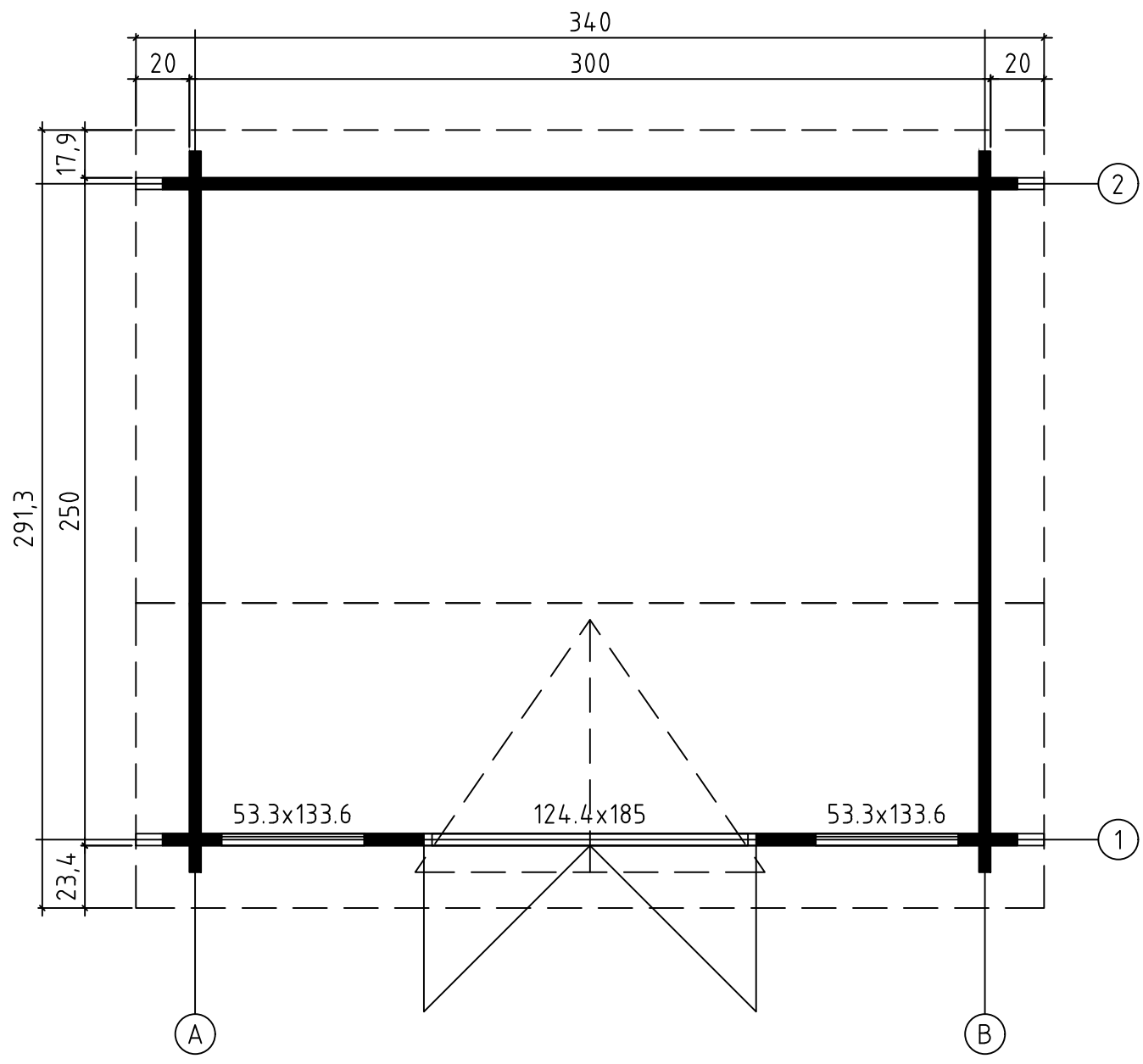

FOUNDATION - FUNDAMENT - FONDATION

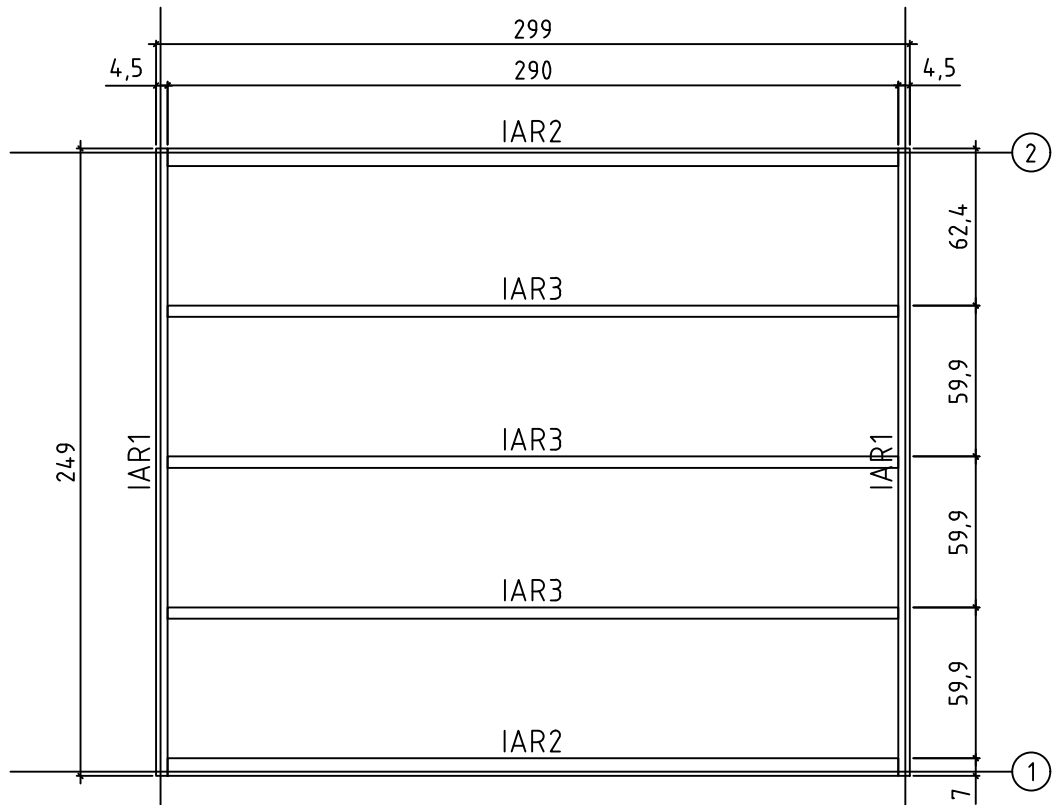

GROUNDPLAN - GRUNDPLAN - PLAN DE MASSE

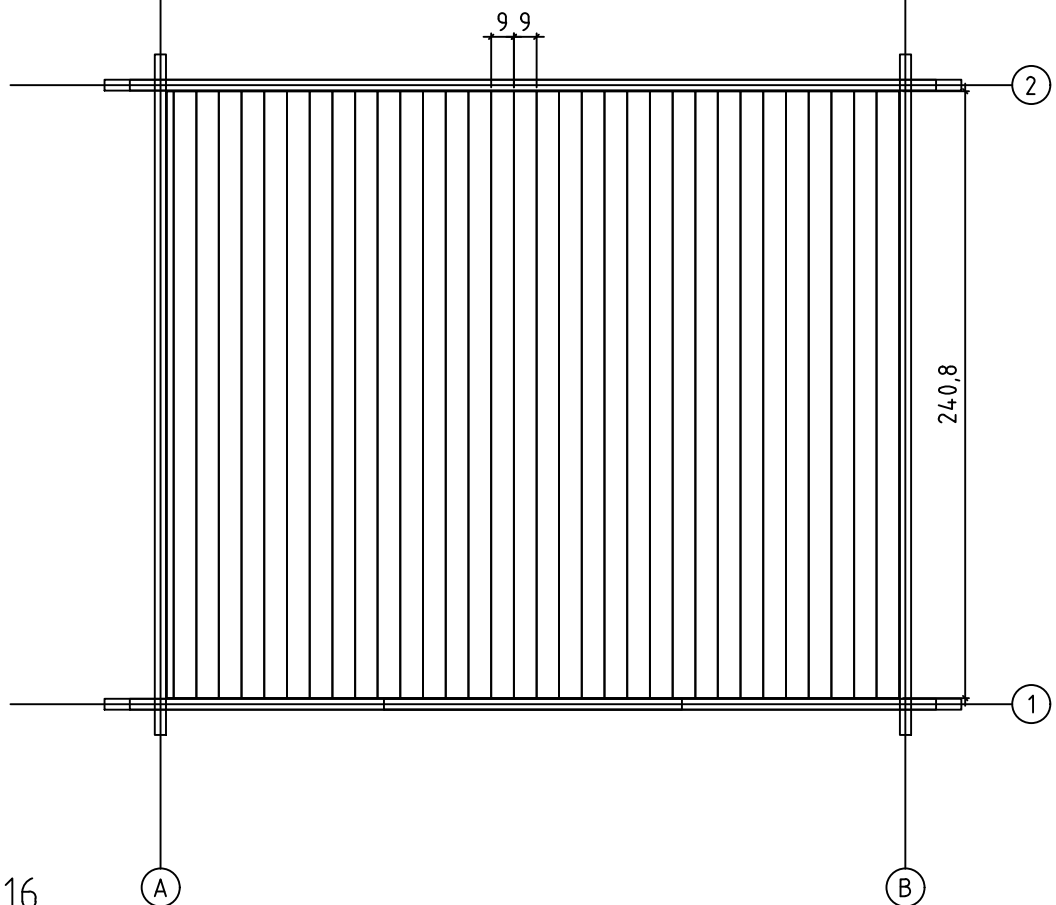

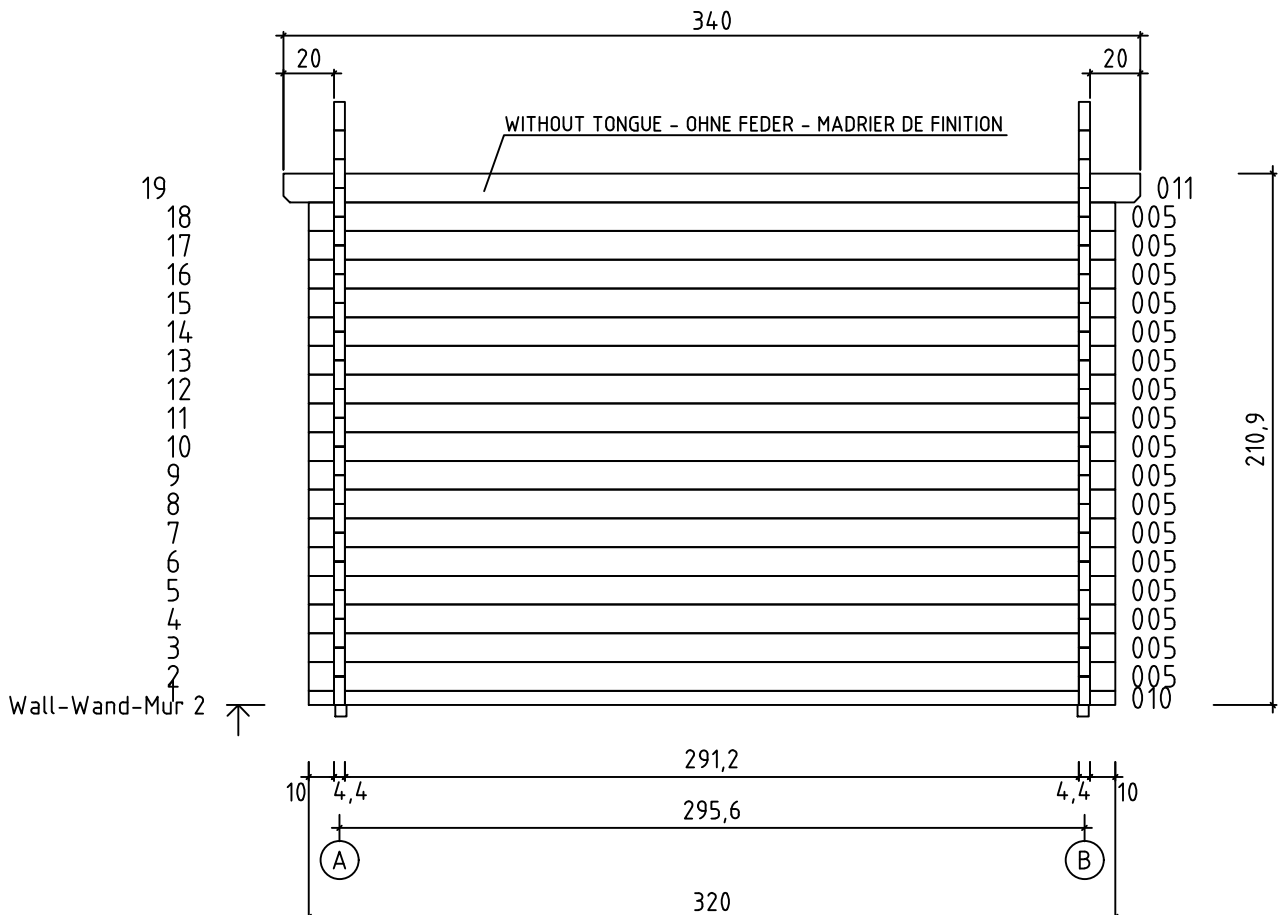
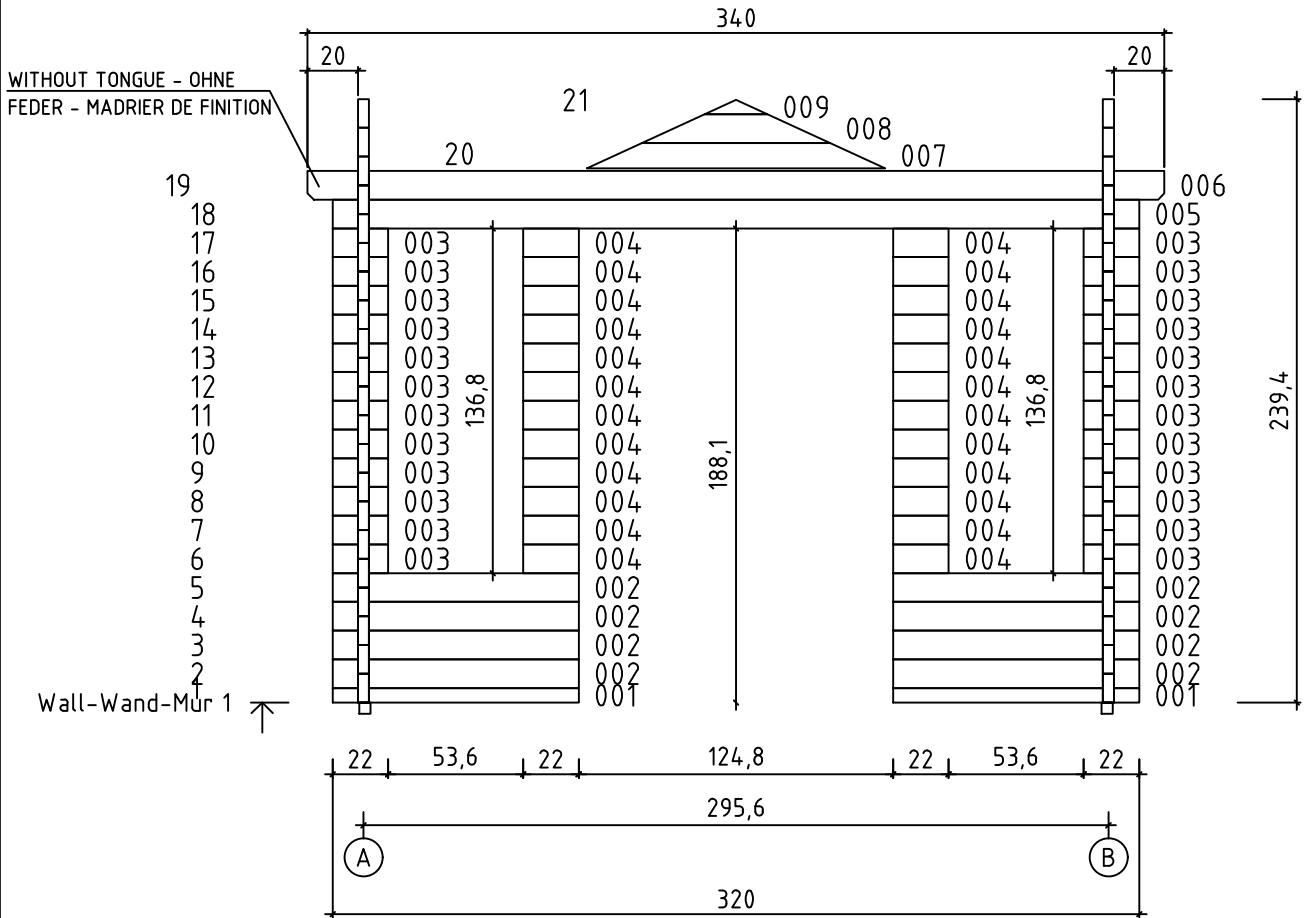

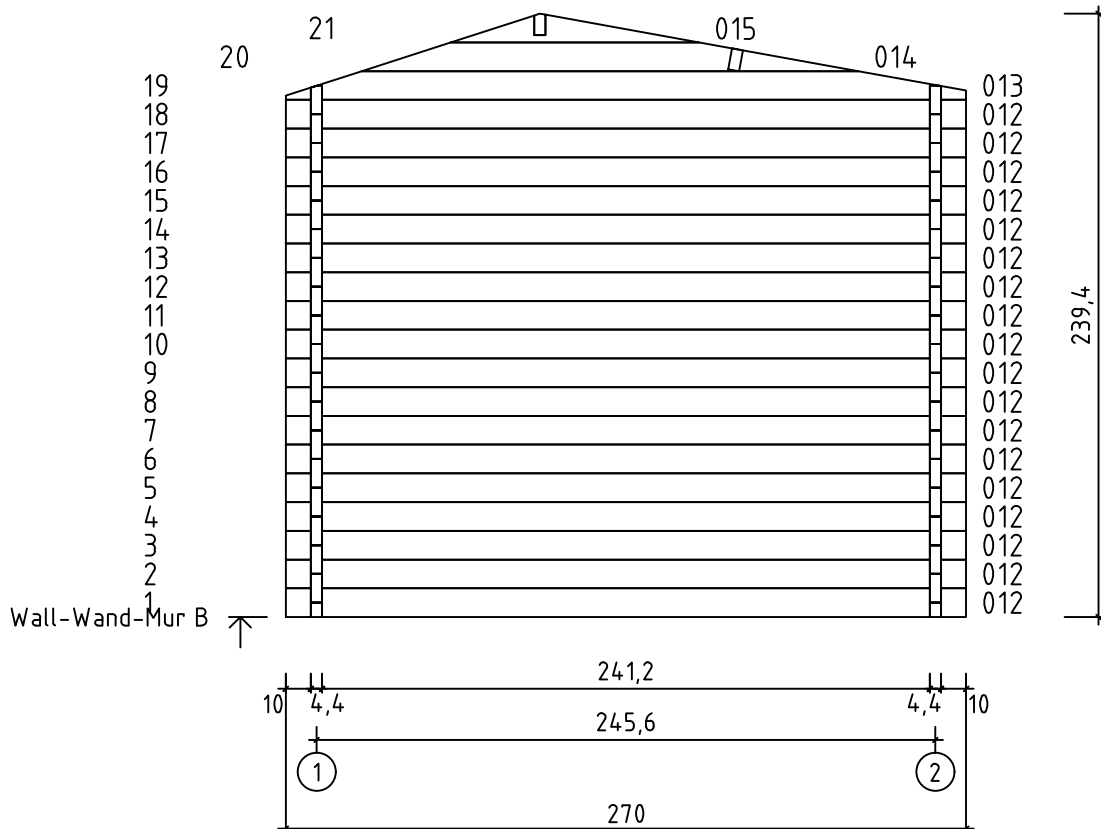
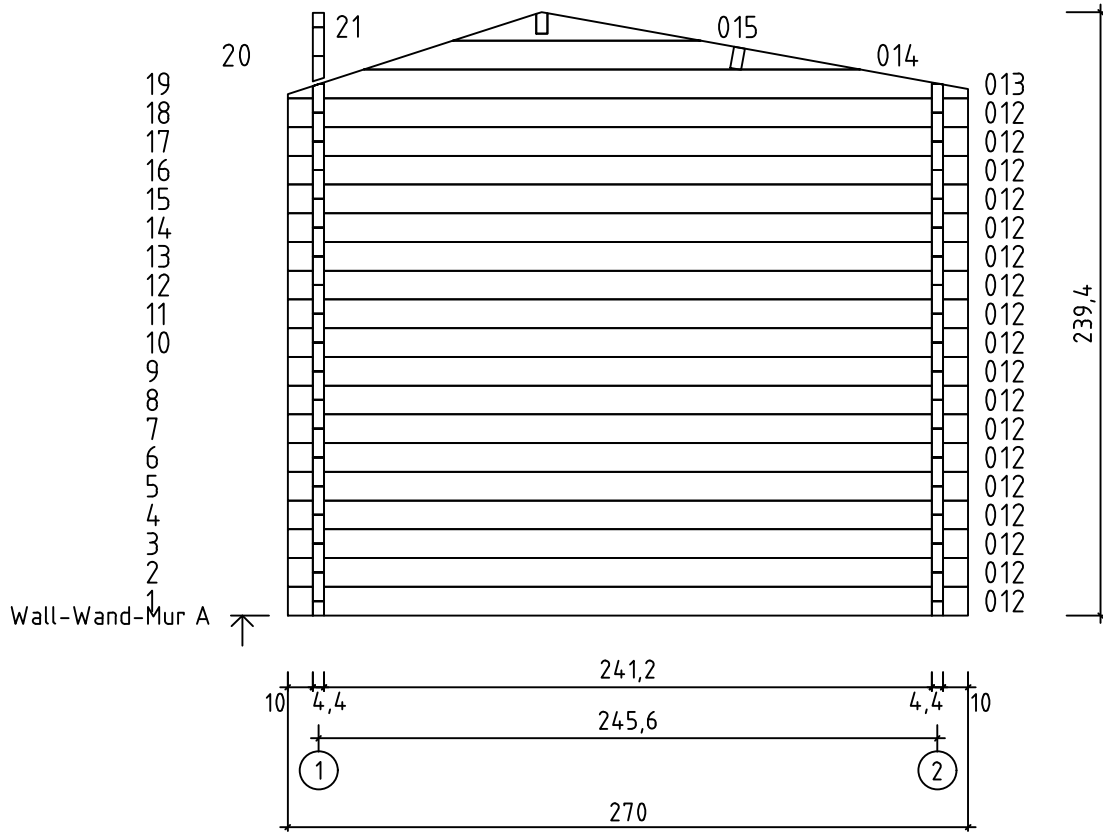

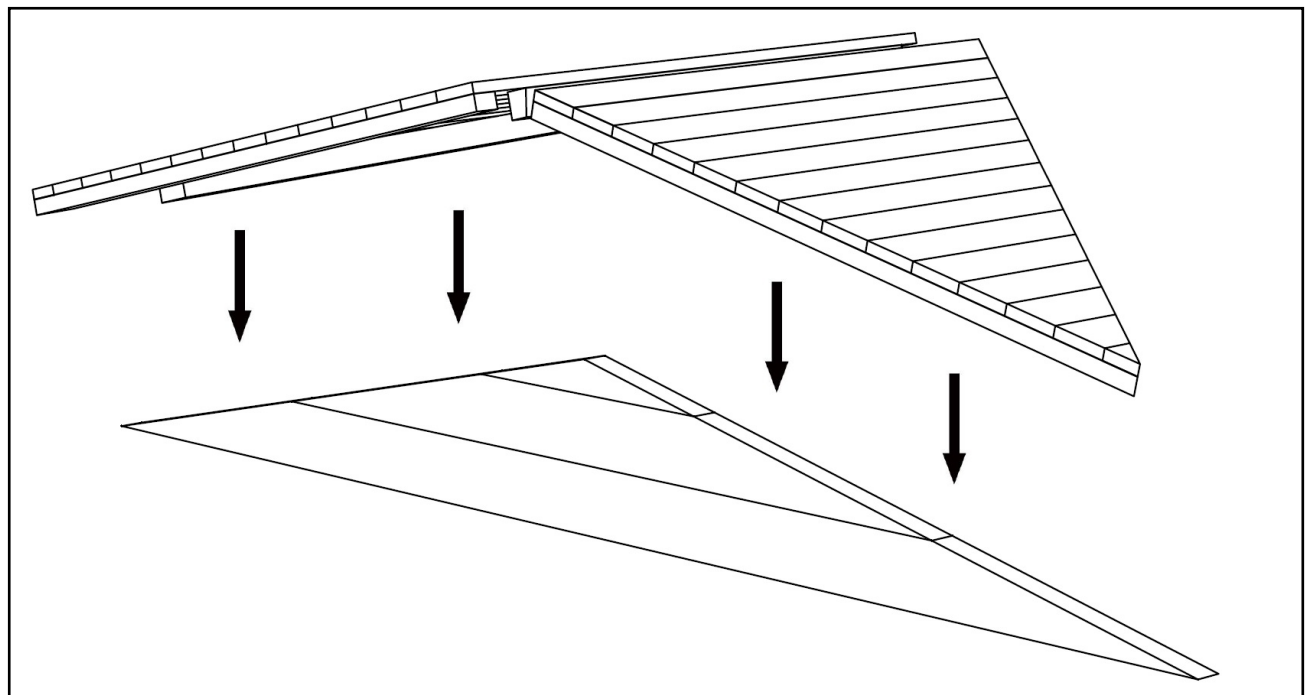
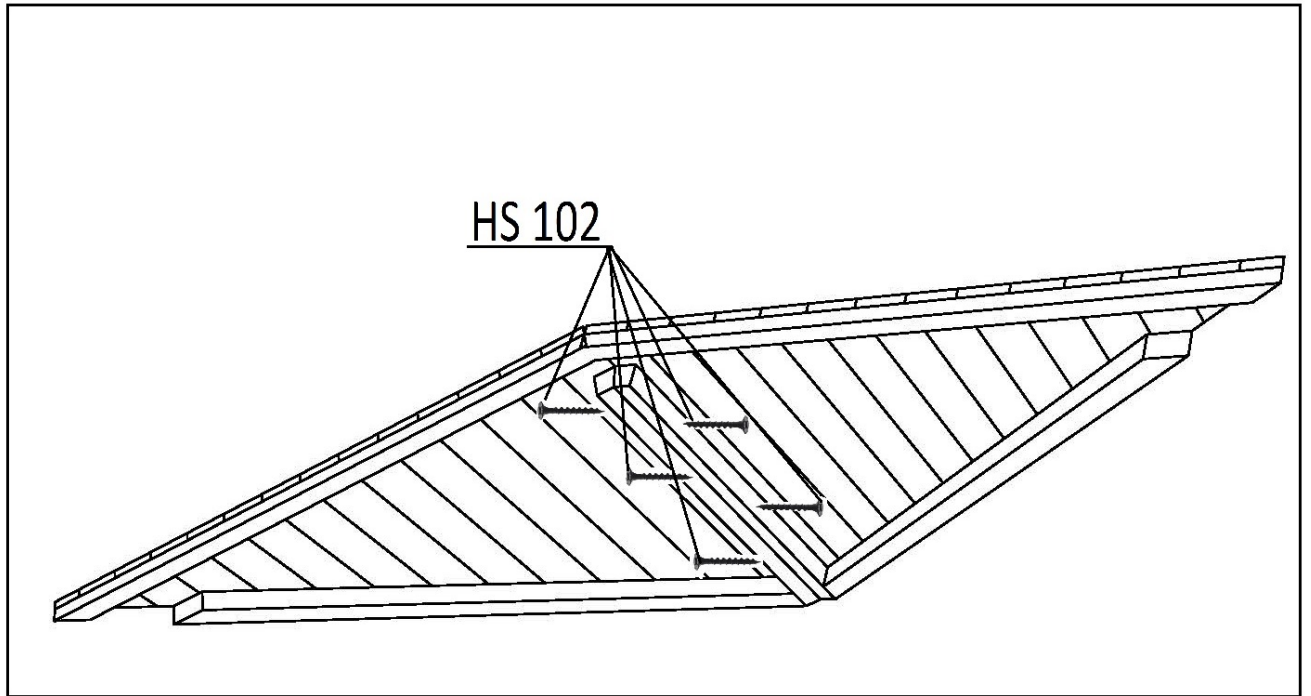

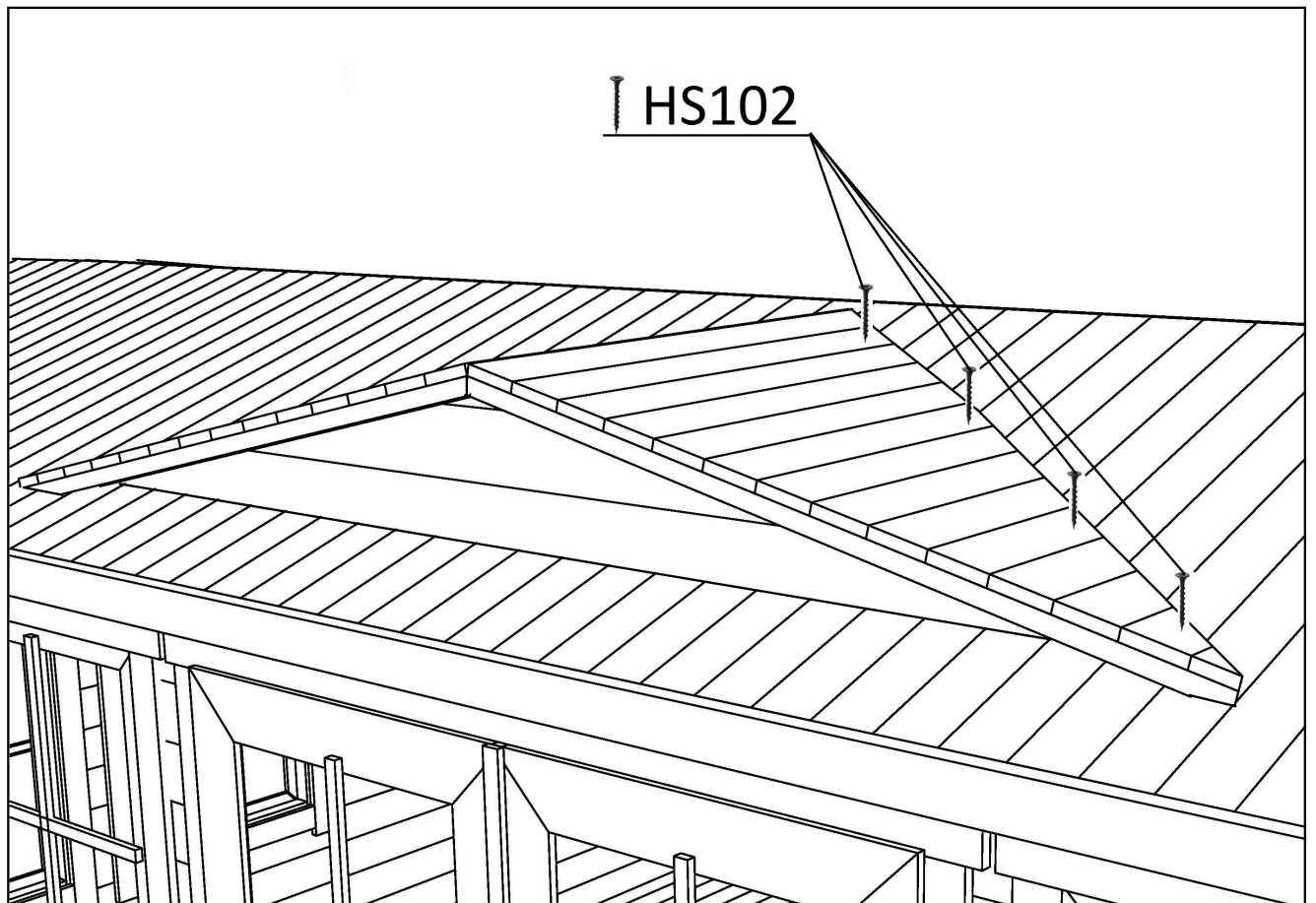
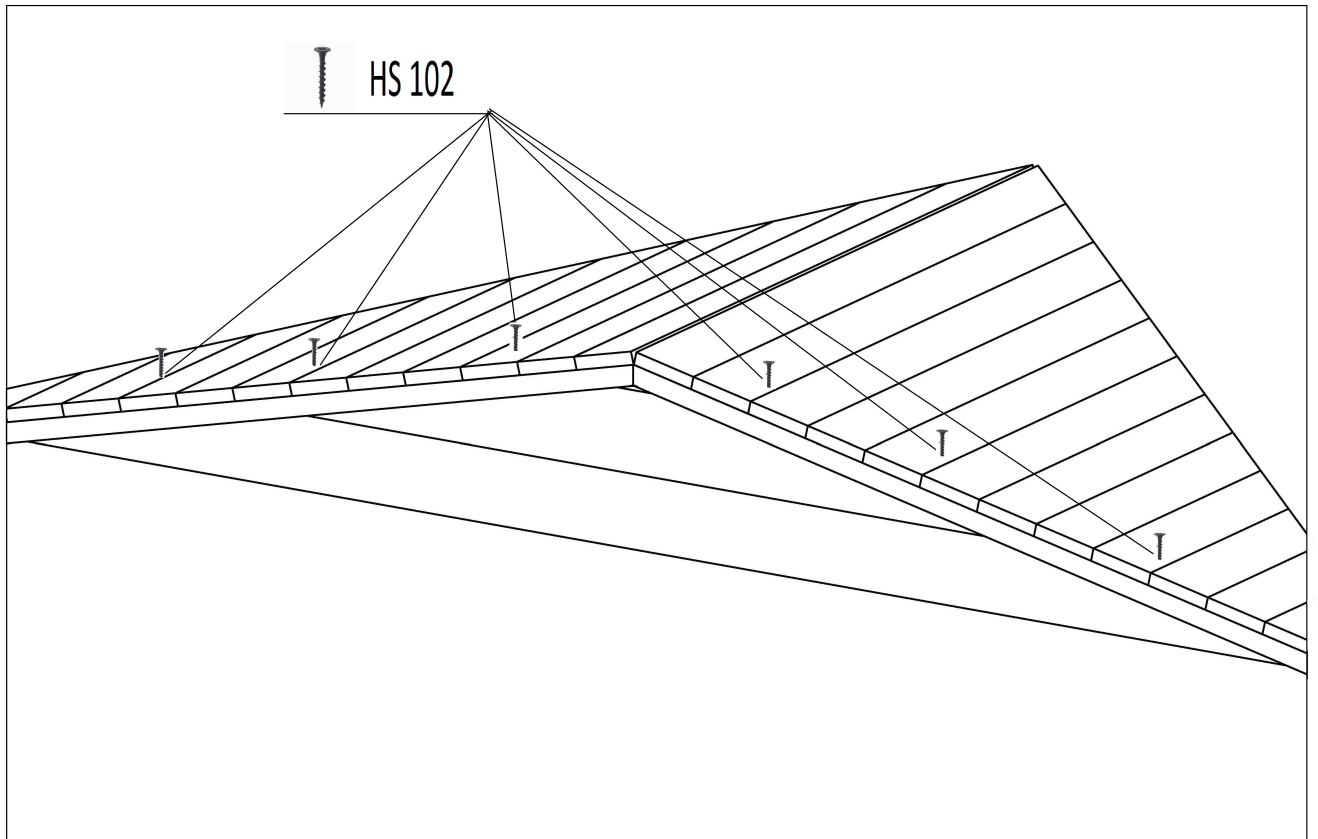

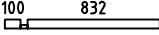
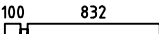

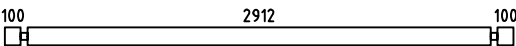
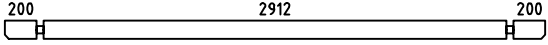
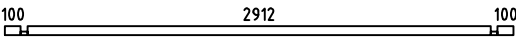
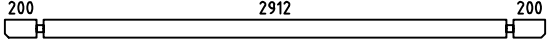
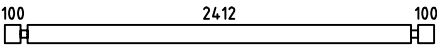
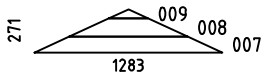
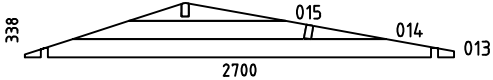
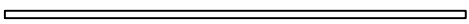
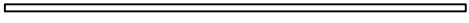
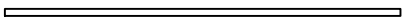
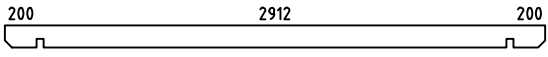
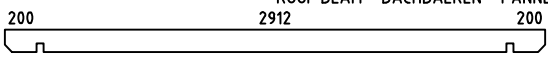



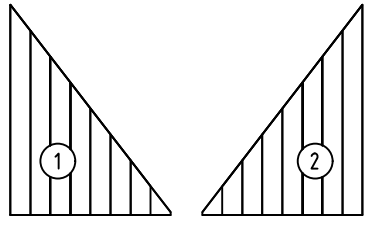





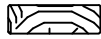
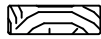
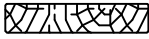

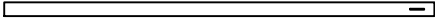
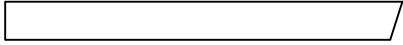
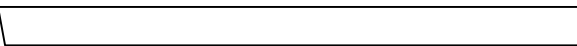
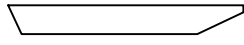

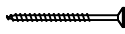
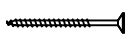

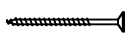

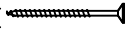
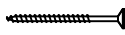
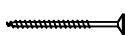
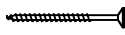
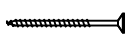

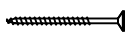
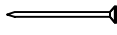



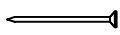
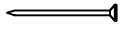
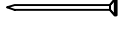
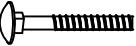

Pos	27.09.2016	Piece list - Stückliste - Liste des pièces Art. Nr. 4421102	8/11	Q	P (mm)	L (mm)
001				2	44x57	976
002				8	44x114	976
003				24	44x114	220
004				24	44x114	220
005				18	44x114	3200
006				1	44x114	3400
010				1	44x57	3200
011				1	44x114	3400
012				36	44x114	2700
W1-1				1		
WA-1 WB-1				1 1		
	FOUNDATION - FUNDAMENT - FONDATION					
IAR2				2	70x45	2900
	FOUNDATION - FUNDAMENT - FONDATION					
IAR3				3	45x45	2900
	FOUNDATION - FUNDAMENT - FONDATION					
IAR1				2	45x45	2490
	ROOF BEAM - DACHBALKEN - PANNE DE TOIT					
PR1				1	44x140	3400
	ROOF BEAM - DACHBALKEN - PANNE DE TOIT					
A-PR1				1	44x140	3400
	FLOOR BOARDS - FUSSBODENBRETTER - LAME DE PLANCHER			33	90x18	2408
	ROOF BOARDS - DACHBRETTER - VOLIGES			38	90x18	1800
	ROOF BOARDS - DACHBRETTER - VOLIGES			38	90x18	1200
	ROOF SHIELD - ELEMENT - PANNEAU DE TOITURE			2	720x945x46	
	FLOOR FILLET - FUSSBODENLEISTE - CORNIERE DE FINITION DU PLANCHER				18x18	10.63
	ROOFING FELT FILLET - DACHPAPPENLEISTE - BAGUETTE DE FIXATION DU FEUTRE BITUMEUX			2	18x58	740

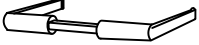

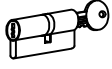
Pos	27.09.2016	Piece list - Stückliste - Liste des pièces Art. Nr. 4421102	9/11	Q	P (mm)	L (mm)
		ROOFING FELT FILLET - DACHPAPPENLEISTE - BAGUETTE DE FIXATION DU FEUTRE BITUMEUX 		2	18x58	1250
		ROOFING FELT FILLET - DACHPAPPENLEISTE - BAGUETTE DE FIXATION DU FEUTRE BITUMEUX 		2	18x58	1850
TB-1		FASCIA BOARD - TRAUFBRETT - BANDEAU DE TOIT 		2	18x90	3400
DRV-1		ROOF EDGE REINFORCEMENT - DACHRANDVERSTÄRKUNG - CORNIERE DE RENFORT DE BORD DE TOIT 		2	28x34	3400
KFS-1		STORM PROTECTION - STURMLEISTE - LATTE ANTI-TEMPETE 		4	22x45	2050
		GABLE MOULDING - GIEBELLEISTE - PLANCHE DE RIVE 		2	18x120	1250
		GABLE MOULDING - GIEBELLEISTE - PLANCHE DE RIVE 		2	18x120	1850
		GABLE MOULDING - GIEBELLEISTE - PLANCHE DE RIVE 		2	18x90	740
FS2		WINDOW HANDLE FITTINGS - FENSTERGRIFF - POIGNEE DE FENETRE 		2	FG10.AL	
HS1		SCREW FOR WINDOW GEORGIAN BARS - SCHRAUBE FÜR FENSTER SPROSSEN - VIS DE BARRES GEORGIENNE DE FENETRE 		20	2.5x20	
HS1		SCREW FOR DOOR GEORGIAN BARS - SCHRAUBE FÜR TÜR SPROSSEN - VIS DE BARRES GEORGIENNE DE PORTE 		20	2.5x20	
HS8		SCREW FOR GABLE SEGMENT - SCHRAUBEN FÜR DECKBLATT - VIS POUR FIXATION LOSANGE DE FINITION 		6	3.5x35	
HS8		SCREW FOR GABLE MOULDING - SCHRAUBEN FÜR GIEBELLEISTE - VIS POUR FIXATION PLANCHE DE RIVE 		34	3.5x35	
HS4		SCREW FOR DOOR FILLET - SCHRAUBE ZUR BEFESTIGUNG TÜRLEISTE - VIS POUR FIXATION BAGUETTE D'ARRET DE PORTE 		5	3x30	
HS12		SCREW FOR FASCIA BOARDS - SCHRAUBEN FÜR TRAUFBRETT - VIS POUR FIXATION BANDEAU DE TOIT 		16	4x40	
HS12		SCREW FOR ROOF EDGE REINFORCEMENT - SCHRAUBEN FÜR DACHRANDVERSTÄRKUNG - VIS POUR FIXATION CORNIERE RENFORT DE BORD DE TOIT 		16	4x40	
HS102		SCREW FOR ROOF SHIELDS - SCHRAUBE FÜR ELEMENT - VIS POUR PANNEAU DE TOITURE 		19	4x60	
HS18		SCREW FOR ROOF BEAMS - SCHRAUBEN FÜR DACHBALKEN - VIS POUR FIXATION PANNES DE TOIT 		8	5x120	
HS16		SCREW FOR 1. WALL BEAM - SCHRAUBE FÜR 1. BOHLENREIHE - VIS DE FIXATIONS 1ere RANGÉE DE MADRIERS AVEC POUTRELLES DE FONDATIONS 		7	5x90	
HS16		SCREW FOR FOUNDATION - SCHRAUBEN ZUR BEFESTIGUNG FUNDAMENT - VIS DE FIXATIONS DES POUTRELLES DE FONDATIONS 		10	5x90	
HS16		SCREW FOR DOOR JAMB - SCHRAUBE FÜR TÜRRAHMEN - VIS DE FIXATION PARTIE HAUTE AVEC MONTANTS DU CADRE DE PORTE 		4	5x90	
HS25		SCREW FOR DOORSTEP - SCHRAUBEN FÜR SWELLE - VIS POUR FIXATION BARRE DE SEUIL 		3	4.5x65	
NF2		ZN NAIL FOR FLOOR FILLET - ZN NÄGEL FÜR FUSSBODENLEISTE - POINTE POUR CORNIERE DE FINITION DU PLANCHER 		21	1.4x40	
SH44		HAMMER BLOCK - SCHLAGHOLZ - CALLE DE FRAPPE 		1		
SFS		NUT FOR STORM PROTECTION - SCHRAUBENMUTTER FÜR STURMLEISTE - ECROU POUR LATTE ANTI-TEMPETE 		8	D8	

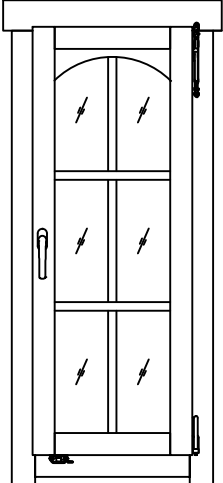
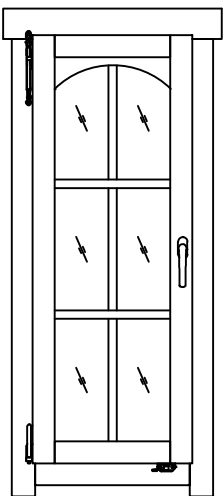
Pos	27.09.2016	Piece list - Stückliste - Liste des pièces Art. Nr. 4421102	10/11	Q	P (mm)	L (mm)
NF4	ZN NAIL FOR ROOF - ZN NÄGEL FÜR DACHBRETTTER - POINTE POUR FIXATION VOLIGES DE TOIT		201	2x50		
NF4	ZN NAIL FOR FLOOR - ZN NÄGEL FÜR FUSSBODENBRETTTER - CLOUS POUR PLANCHER		170	2x50		
NF5	ZN NAIL FOR ROOFING FELT FILLET - ZN NÄGEL FÜR DACHPAPPENLEISTE - POINTE POUR BAGUETTE DE FIXATION FEUTRE BITUMEUX		24	2x40		
BFS	BOLT FOR STORM PROTECTION - BOLZEN FÜR STURMLEISTE - BOULON POUR LATTE ANTI-TEMPETE		8	8x80		
	MALE BOLT HINGE FOR DOOR - TÜRRIEGEL - PARTIE MALE DE PAUMELLE DE PORTE		6	14/80		
GS	GABLE SEGMENT - DECKBLATT - LOSANGE DE FINITION		3			
DFS	WASHER FOR STORM PROTECTION - DICHTSCHEIBE FÜR STURMLEISTE - RONDELLE POUR LATTE ANTI-TEMPETE		8	D8		
TL4	DOOR HANDLE FITTINGS - TÜRGRIF - POIGNEE DE PORTE		1			
TL5	SET OF DOOR LOCK COVERS - SCHLOSSBLENDEN - SET DE GARNITURES DE PORTE		1			
	CYLINDER LOCK - ZYLINDERSCHLOSS - BARILLET DE PORTE		1	30/35		
	STRIKER FOR BARREL BOLT - HÜLSE FÜR GRENDELRIEGEL - GACHE AU SOL DU TARGETTE		2			
	WINDOW - FENSTER - FENETRE 533x1336		AK.1.106.PSP.Kg DGP+A+	1		
						
	WINDOW - FENSTER - FENETRE 533x1336		AK.1.106.PSV.Kg DGP+A+	1		
						

Pos	27.09.2016	Piece list - Stückliste - Liste des pièces Art. Nr. 4421102	11/11	Q	P (mm)	L (mm)
	DOOR - TÜR - PORTE 1244x1850	TUK.2.066.PVP.MM.KWe DGP+A+		1		
