

*Staffordshire 1 44*

*Art.No. 4421602*

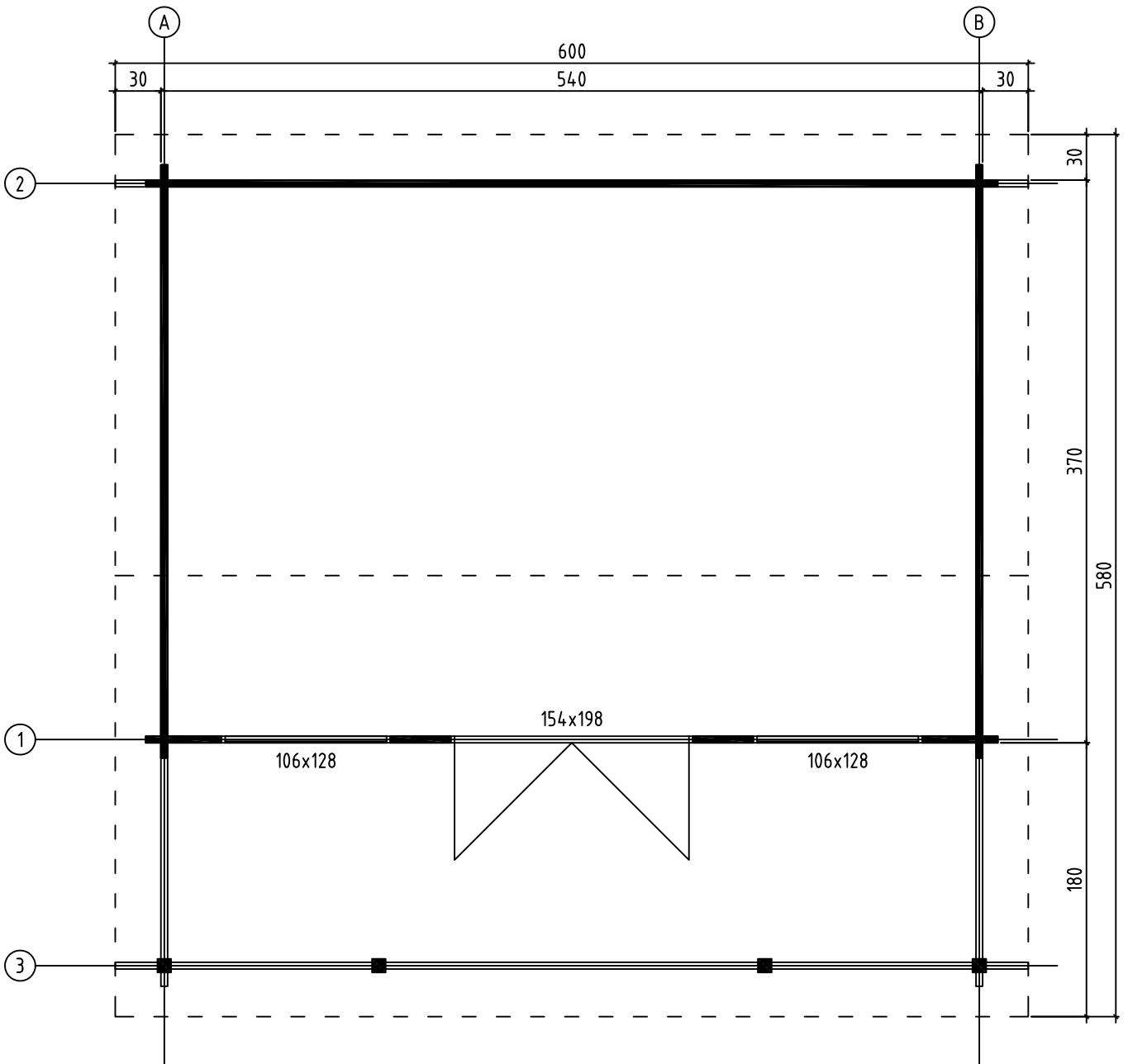

Staffordshire 144, Art.No.4421602  
GROUNDPLAN - GRUNDPLAN - PLAN DE MASSE



Staffordshire 144, Art.No.4421602  
FOUNDATION - FUNDAMENT - FONDATION

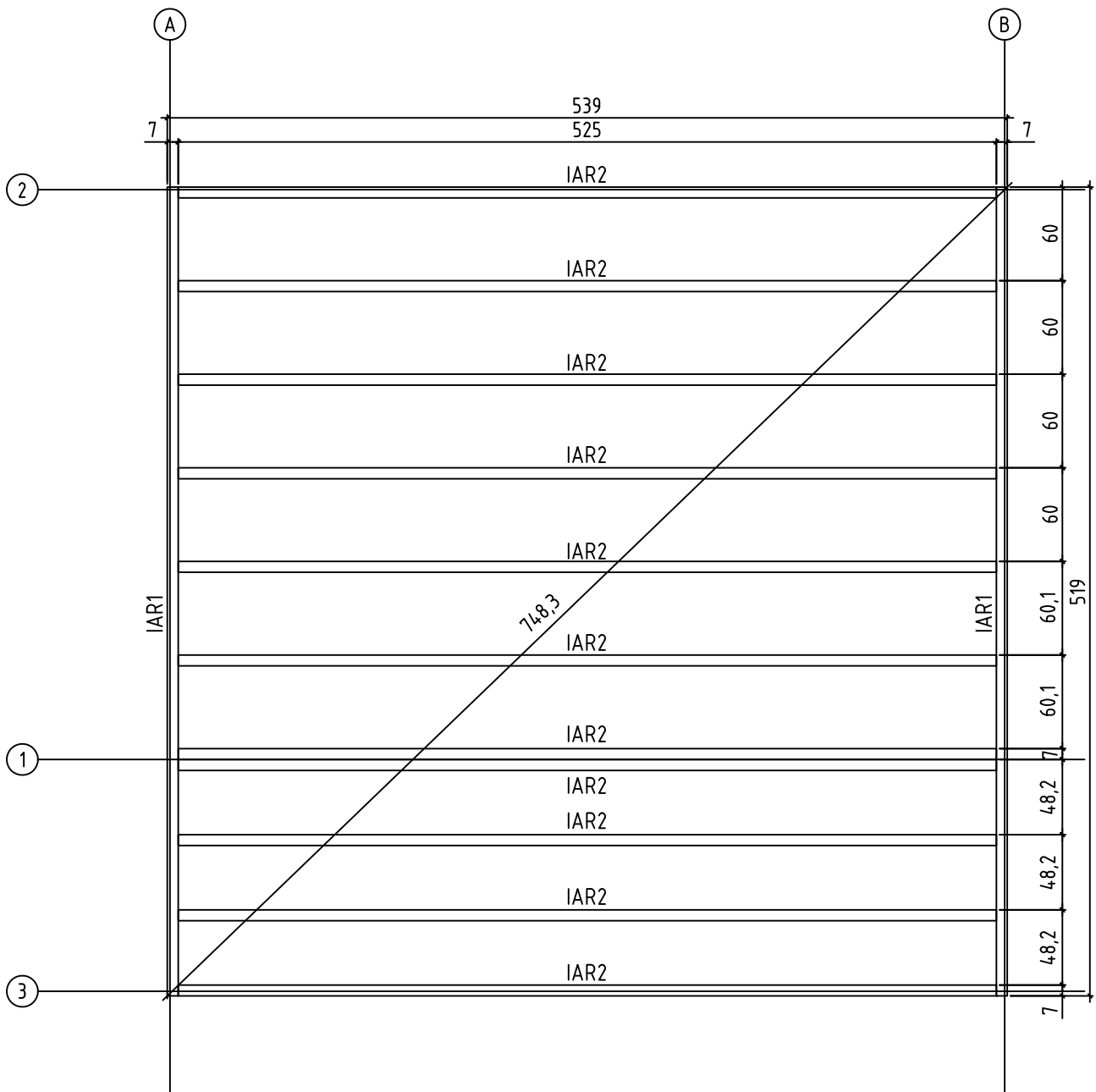

Staffordshire 144, Art.No.4421602  
FLOOR BOARDS - FUSSBODENBRETTER - PLAN POSE PLANCHER

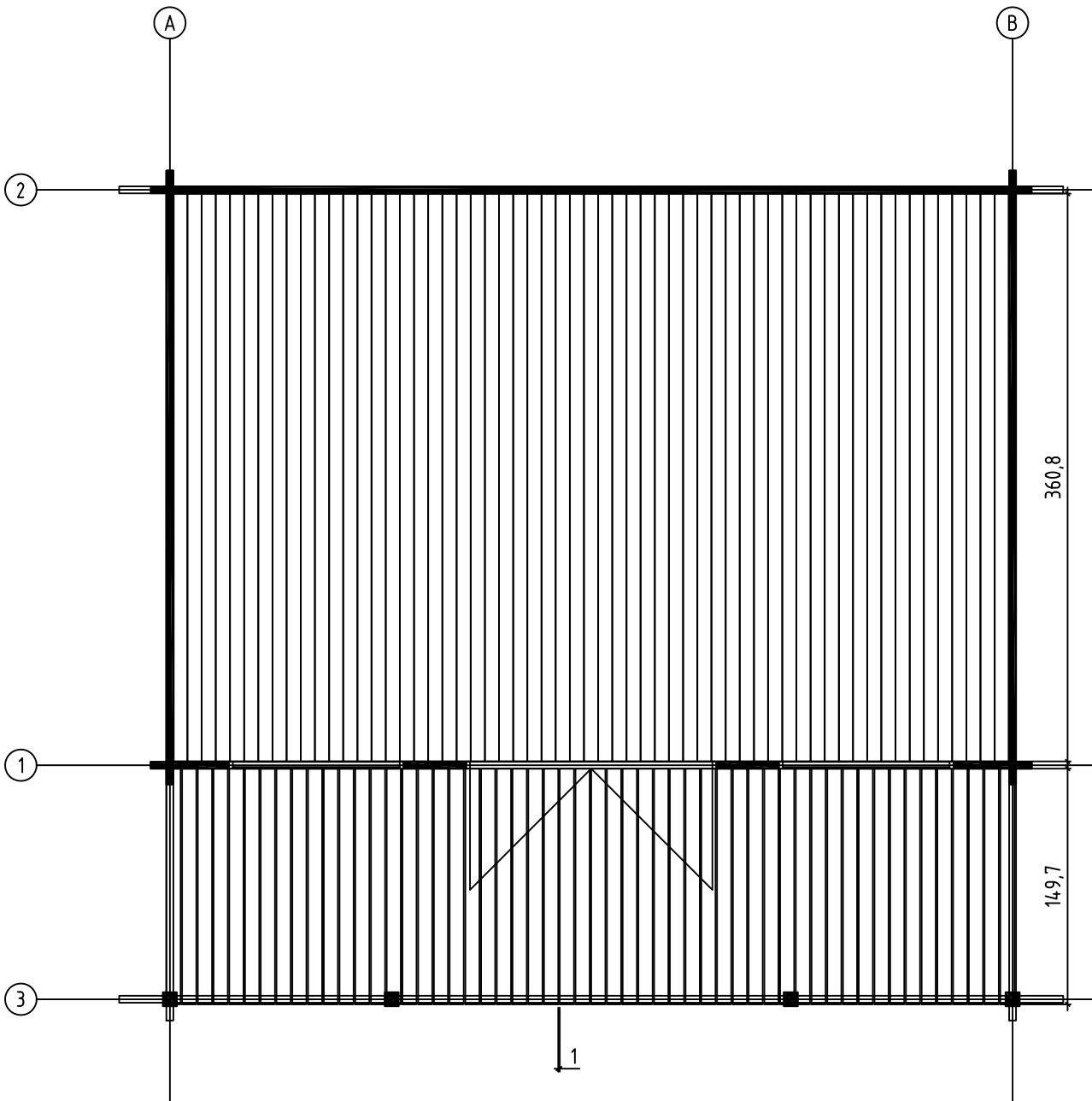

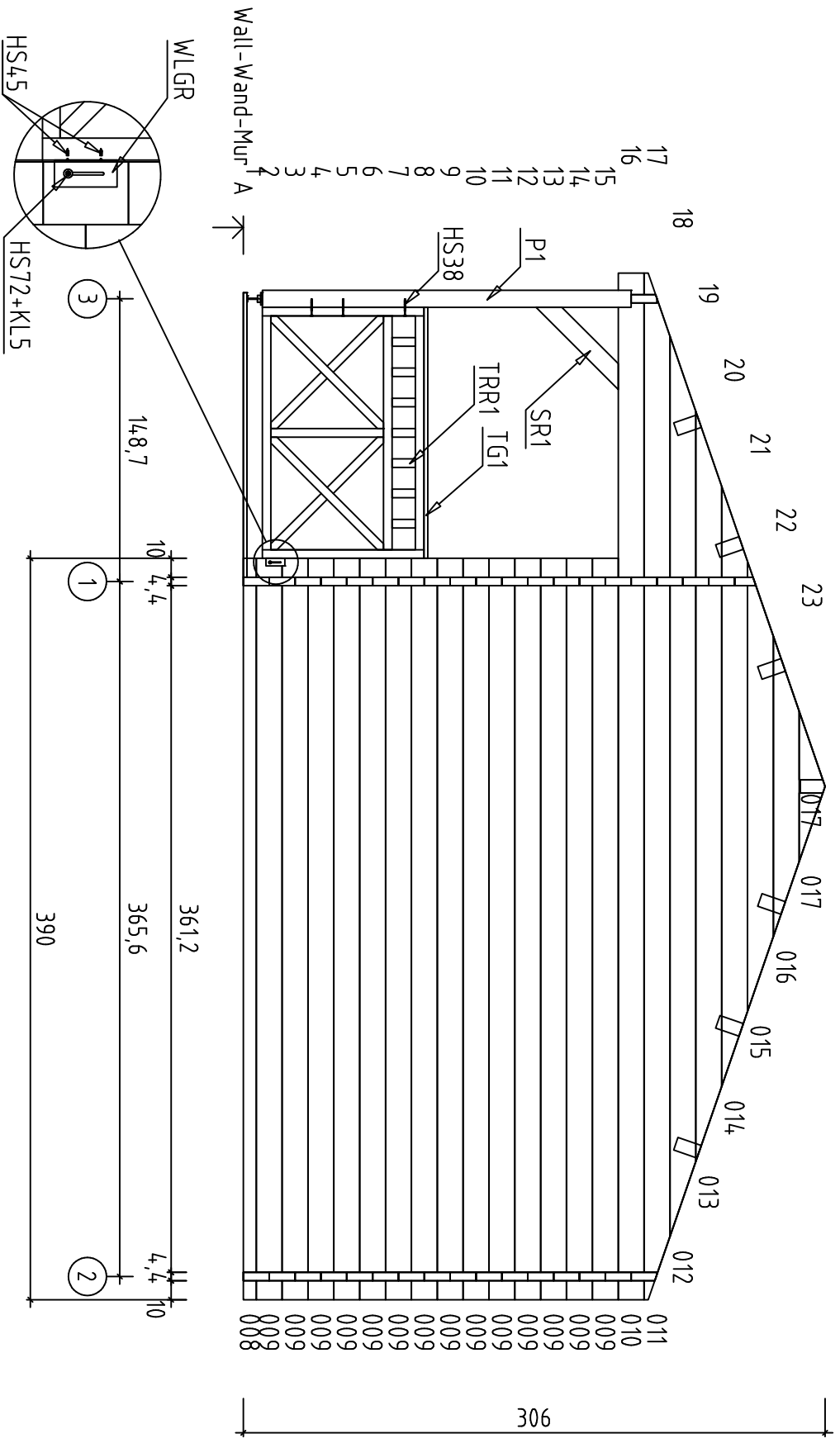

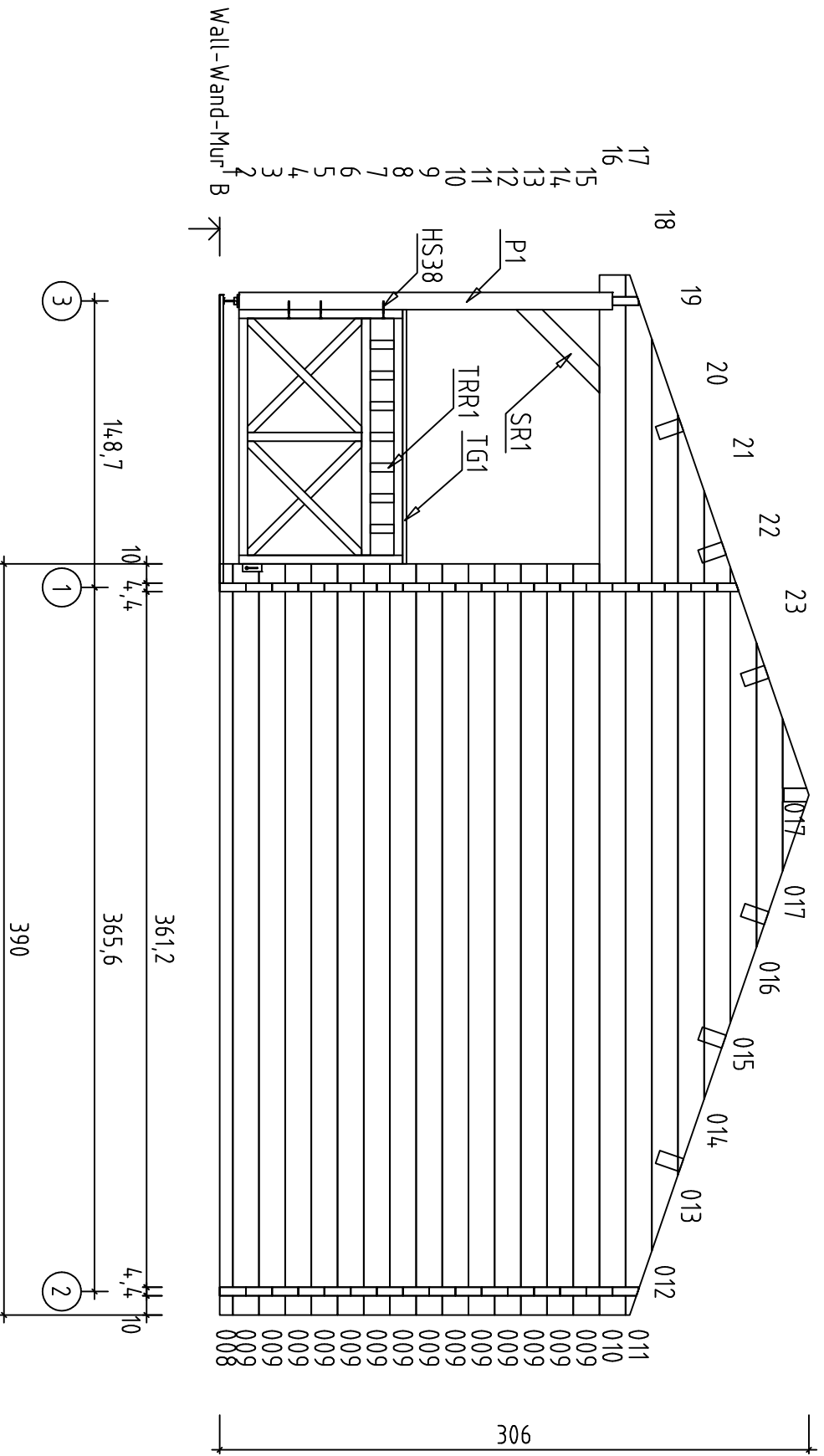

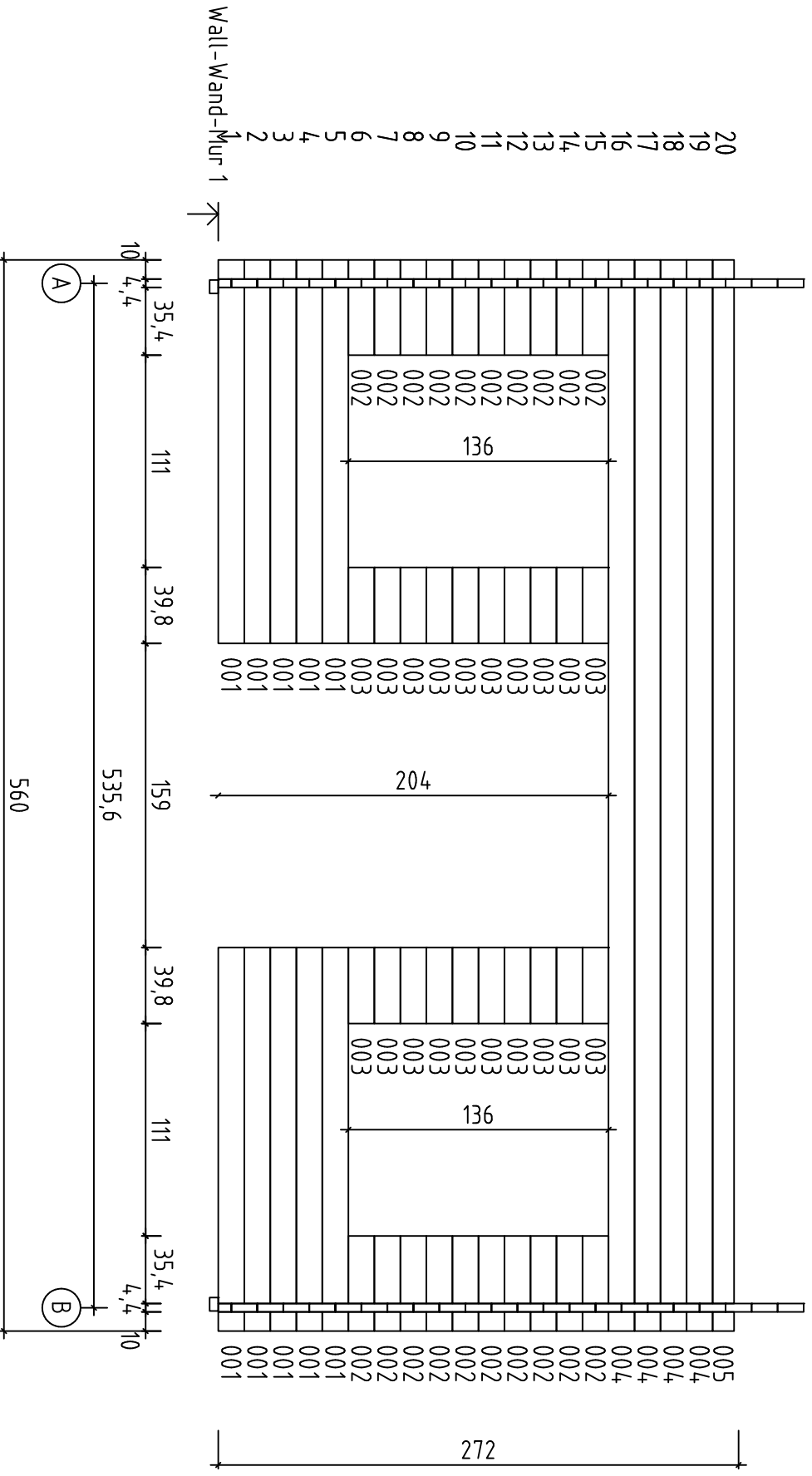



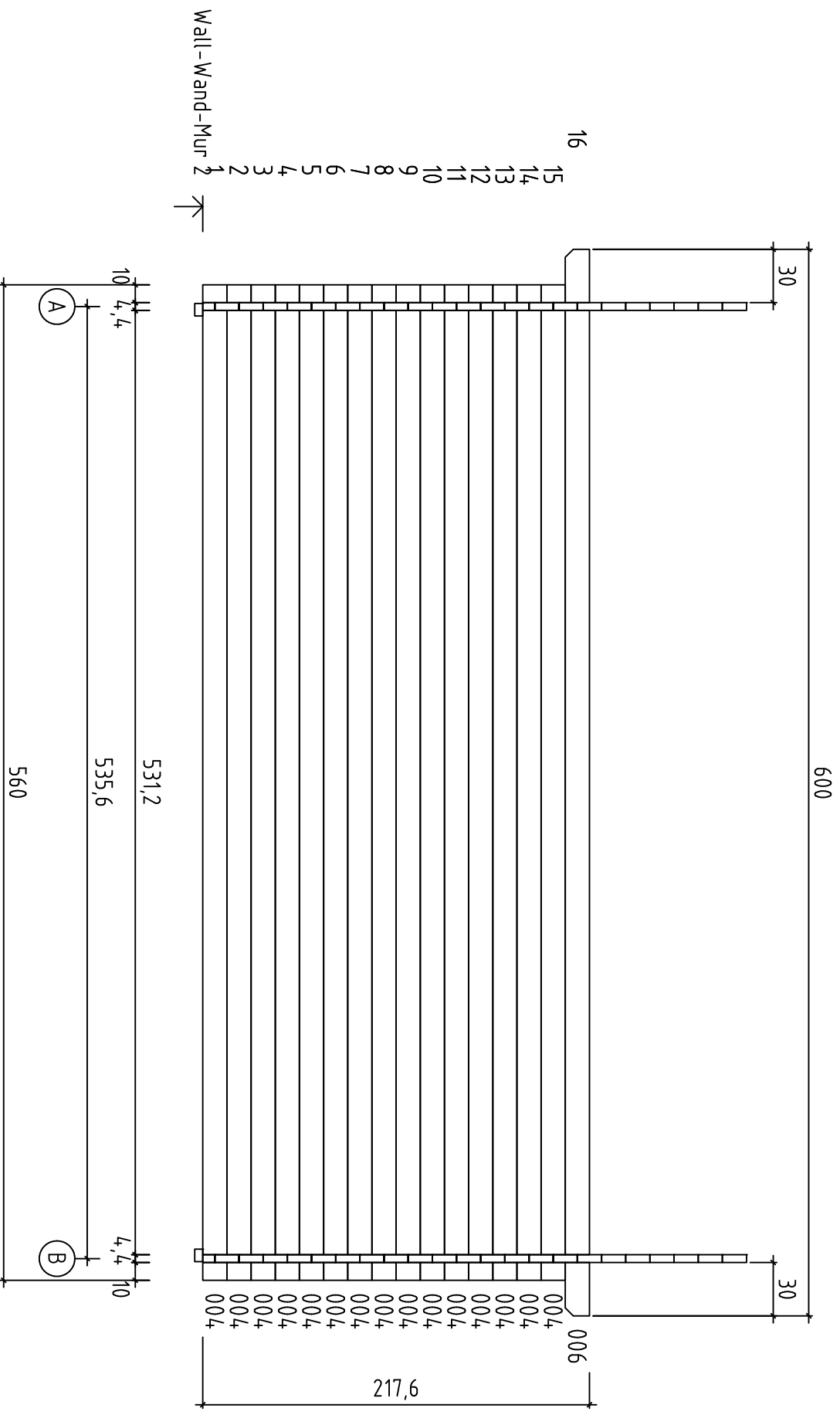



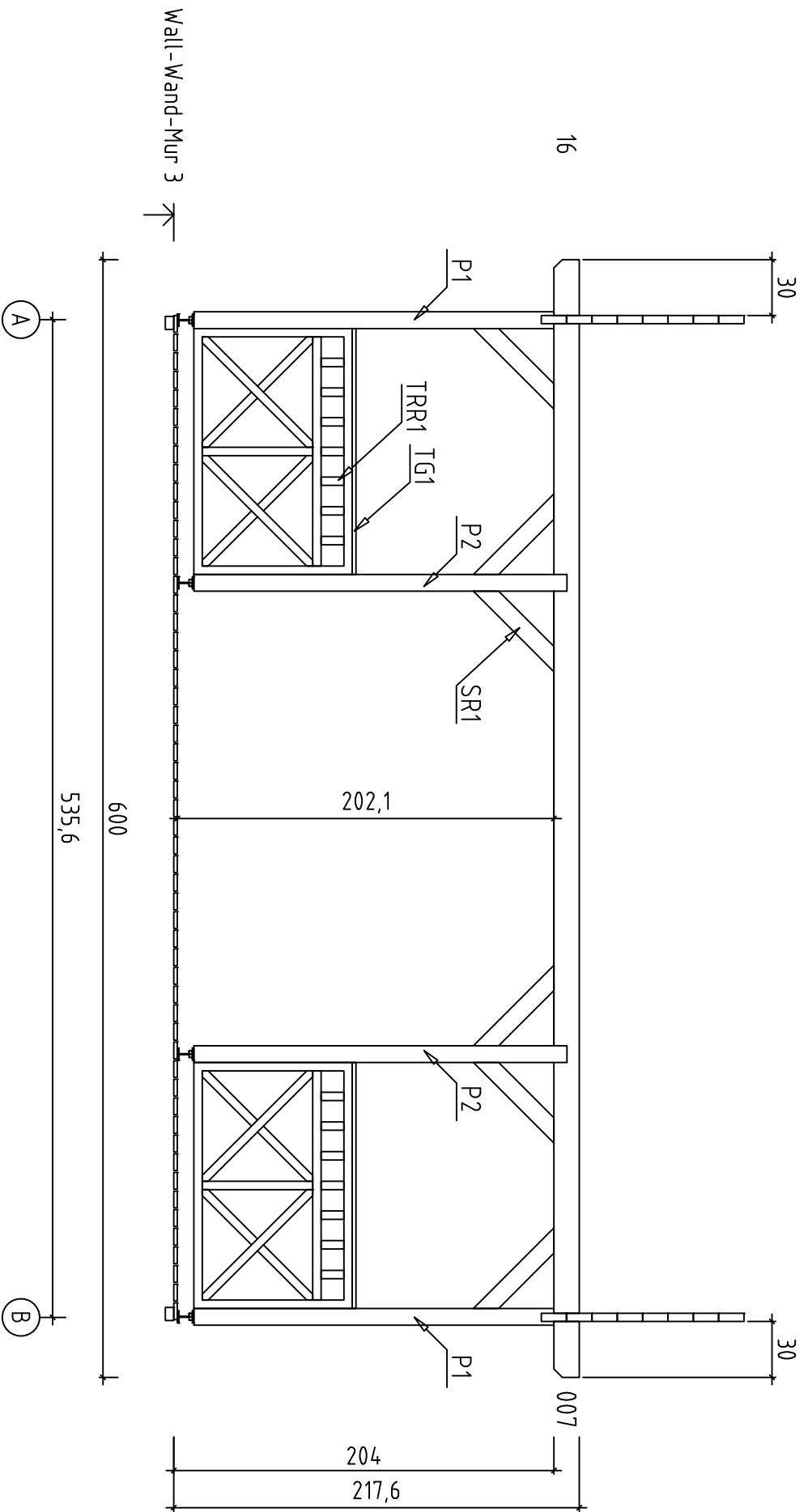

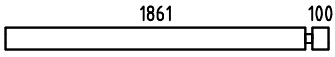

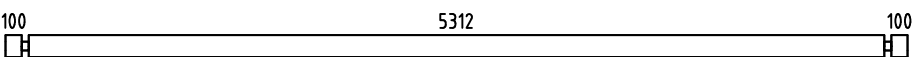
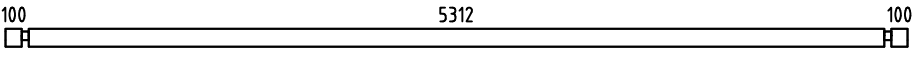
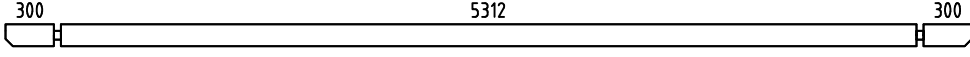
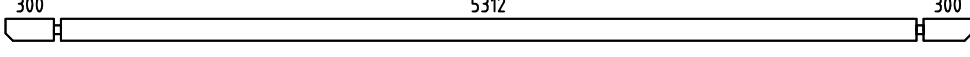
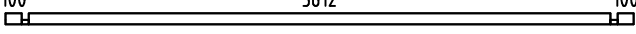
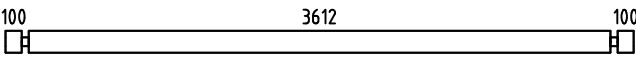
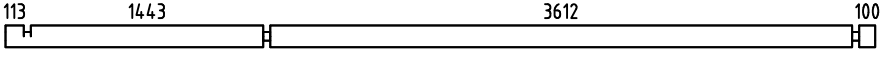
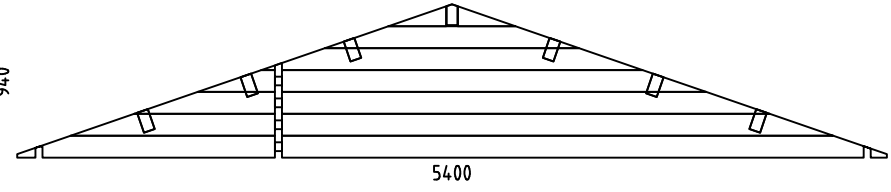
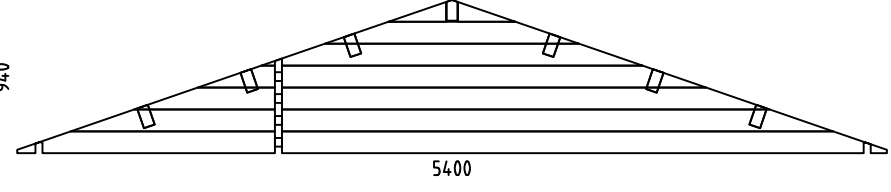

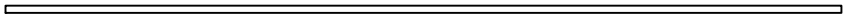
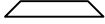
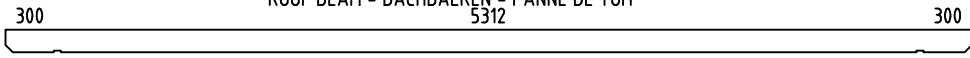
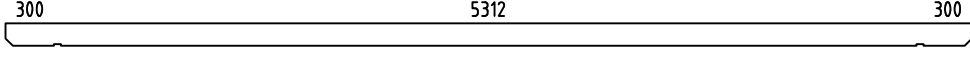

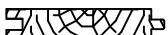









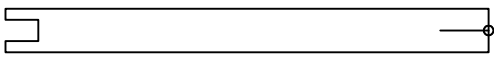

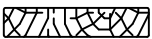
- 20
- 19
- 18
- 17
- 16
- 15
- 14
- 13
- 12
- 11
- 10
- 9
- 8
- 7
- 6
- 5
- 4
- 3
- 2
- 1

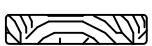
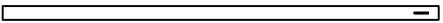

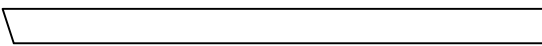

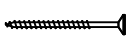

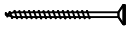
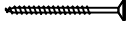

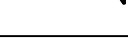
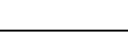
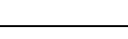
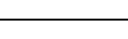

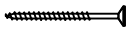





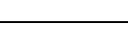
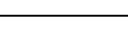
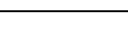

Pos	Staffordshire 144, Art.No.4421602 Piece list - Stückliste - Liste des pieces	Q.	P (mm)	L (mm)
001		10	44x136	2005
002		20	44x136	498
003		20	44x136	397
004		19	44x136	5600
005		1	44x112	5600
006		1	44x136	6000
007		1	44x136	6000
008		2	44x68	3900
009		28	44x136	3900
010		2	44x136	5400
WA-1		1		
WB-1		1		
IAR2	FOUNDATION - FUNDAMENT - FONDATION 	11	70x45	5250
IAR1	FOUNDATION - FUNDAMENT - FONDATION 	2	70x45	5190
SR1	RAFTER - DACHSPARREN - CHEVRON 	8	45x96	707
PR1	ROOF BEAM - DACHBALKEN - PANNE DE TOIT 	1	70x140	6000
A-PR1	ROOF BEAM - DACHBALKEN - PANNE DE TOIT 	6	70x140	6000
	FLOOR BOARDS - FUSSBODENBRETTER - LAME DE PLANCHER 	59	90x18	3608
	ROOF BOARDS - DACHBRETTER - VOLIGES 	134	90x18	3067
SV	TERRACE BOARDS - TERRASSENBRETTER - PLANCHER DE TERRASSE 	54	90x19	1497
	FLOOR FILLET-FUSSBODENLEISTE - CORNIERE DE FINITION DU PLANCHER 		15x40	17.8 m.

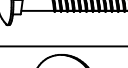
Pos	Staffordshire 144, Art.No.4421602 Piece list - Stückliste - Liste des pieces	Q.	P (mm)	L (mm)
DPL	ROOFING FELT FILLET - DACHPAPPENLEISTE - BAGUETTE DE FIXATION DU FEUTRE BITUMEUX 	4	18x58	3117
LPL	FIXING FILLET - FIXIRUNGSLEISTE - PROFIL DE FIXATION 	4	20x45	1060
LPL	FIXING FILLET - FIXIRUNGSLEISTE - PROFIL DE FIXATION 	4	20x45	1320
LPL	FIXING FILLET - FIXIRUNGSLEISTE - PROFIL DE FIXATION 	1	20x45	1540
LPL	FIXING FILLET - FIXIRUNGSLEISTE - PROFIL DE FIXATION 	2	20x45	2000
P1	POST - PFOSTEN - POTEAU 	2	90x90	1930
P2	POST - PFOSTEN - POTEAU 	2	90x90	2000
TB	EAVES BOARD - TRAUFBRETT - BANDEAU DE TOIT 	2	18x90	6000
DRV	ROOF EDGE REINFORCEMENT - DACHRANDVERSTÄRKUNG - CORNIERE DE RENFORT DE BORD DE TOIT 	4	28x34	3000
TG1	GUARD-RAIL FOR TERRACE - TERRASSEN GELÄNDER - MAIN COURANTE DE TERRASSE 	4	18x90	1320
KFS	STORM PROTECTION - STURMLEISTE LATTE ANTI-TEMPETE 	2	22x45	2085
KFS	STORM PROTECTION - STURMLEISTE LATTE ANTI-TEMPETE 	2	22x45	2600
GL	GABLE MOULDING - GIEBELLEISTE PLANCHE DE RIVE 	4	18x120	3117
SH70	HAMMER BLOCK - SCHLAGHOLZ - CALLE DE FRAPPE 	1		
HS12	SCREW FOR GABLE SEGMENT - SCHRAUBEN FÜR DECKBLATT - VIS POUR FIXATION LOSANGE DE FINITION 	4	3.5x35	
HS83	SCREW FOR FIXING FILLET - SCHRAUBEN FÜR FIXIRUNGSLEISTE - VIS POUR PROFIL DE FIXATION 	51	3.5x50	
HS16	SCREW FOR GABLE MOULDING - SCHRAUBEN FÜR GIEBELLEISTE - VIS DE FIXATION POUR PLANCHE DE RIVE 	40	3.5x50	
HS38	SCREW FOR FIXING TERRACE RAILING - SCHRAUBE FÜR TERRASSE VIS DE FIXATION DE GARDE-CORPS DE TERRASSE 	20	4.5x80	
NFD	SCREW FOR ROOFING FELT FILLET - SCHRAUBEN FÜR DACHPAPPENLEISTE - VIS POUR BAGUETTE FIXATION FEUTRE BITUMEUX 	28	4x40	
HS32	SCREW FOR EAVES BOARDS - SCHRAUBEN FÜR TRAUFBRETT - VIS DE FIXATION POUR BANDEAU DE TOIT 	26	4x40	
HS26	SCREW FOR ROOF EDGE REINFORCEMENT - SCHRAUBEN FÜR DACHRANDVERSTÄRKUNG - VIS POUR RENFORT DE BORD DE TOIT 	26	4x40	
HS45	SCREW FOR SLIDING WALL TIE - SCHRAUBEN FÜR WAND SCHIEBEREGLER SCHIEBEREGLER - VIS POUR FIXATION ÉQUERRE MÉTALLIQUE AU PARAVENT 	8	4x40	
HS34	SCREW FOR POST - SCHRAUBEN FÜR PFOSTEN - VIS DE FIXATION DES POTEAUX 	8	4x40	
HS30	SCREW FOR TERRACE REAR BOARDS - SCHRAUBEN FÜR TERRASSEN RAND - VIS DE FIXATION POUR MAIN COURANTE DE TERRASSE 	16	4x60	
HS40	SCREW FOR 1. WALL BEAM - SCHRAUBE FÜR 1. BOHLENREIHE - VIS DE FIXATION DES FONDATIONS 	8	5x120	

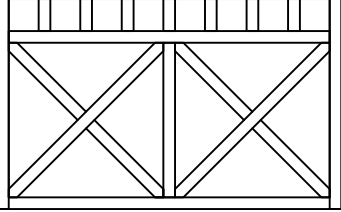
Pos	Staffordshire 144, Art.No.4421602 Piece list - Stückliste - Liste des pieces	Q.	P (mm)	L (mm)
HS39	SCREW FOR FUNDAMENT - SCHRAUBEN ZUR BEFESTIGUNG FUNDAMENT - VIS POUR FONDATION 	46	5x120	
HS42	SCREW FOR GABLE - SCHRAUBEN FÜR GIEBEL - VIS POUR FIXATION DES PIGNONS 	28	5x120	
HS43	SCREW FOR ROOF BEAMS - SCHRAUBEN FÜR DACHBALKEN - VIS POUR PANNE DE TOIT 	14	5x120	
HS44	SCREW FOR RAFTER - SCHRAUBEN ZUR BEFESTIGUNG DACHSPARREN - VIS POUR CHEVRON 	16	6x180	
HS49	SCREW FOR POST HEIGHT ADJUSTMENT - SCHRAUBEN FÜR REGULIERUNGSSCHRAUBE FÜR PFOSTEN - VIS DE FIXATION DE SUPPORT RÉGLABLE DE POTEAU 	32	6x50	
MS	SCREW FOR DOORSTEP - SCHRAUBEN FÜR TÜRSCHWELLE - VIS DE FIXATION DU SEUIL DE PORTE 	3	4.5x65	
HS72	SCREW FOR SLIDING WALL TIE - SCHRAUBEN FÜR WAND SCHIEBEREGLER - VIS POUR FIXATION ÉQUERRE MÉTALLIQUE AU PARAVENT 	2	5x60	
NF3	ZN NAIL FOR TERRACE - ZN NÄGEL FÜR TERRASSENBRETTEN - POINTE POUR PLANCHER DE TERRASSE 	435	2x50	
NFF	ZN NAIL FOR FLOOR FILLETS - ZN NÄGEL FÜR FUSSBODENLEISTEN - POINTE POUR PANNEAUX DE PLANCHER 	35	1.4x40	
NF2	ZN NAIL FOR ROOF - ZN NÄGEL FÜR DACHBRETTEN - POINTE POUR TOIT 	740	2x50	
NH1	ZN NAIL FOR FLOOR - ZN NÄGEL FÜR FUSSBODENBRETTEN - CLOUS POUR PLANCHER 	430	2x50	
ORZ	MONTAGE SET FOR DOORS AND WINDOWS - MONTAGE-SET FÜR TÜREN UND FENSTER - JEU DE MONTAGE PORTES ET FENETRES	1		
GS	GABLE SEGMENT-DECKBLATT - LOSANGE DE FINITION 	2		
KL5	PLAIN WASHER FOR SLIDING WALL TIE - UNTERLEGSSCHEIBE FÜR WAND SCHIEBEREGLER - RONDELLE POUR SABOT MÉTALLIQUE 	2		
WLGR	SLIDING WALL TIE - SCHIEBEREGLER FÜR WAND - EQUERRE MÉTALLIQUE DE FIXATION DU PARAVENT 	2		
SFS	NUT FOR STORM PROTECTION - SCHRAUBENMUTTER FÜR STURMLEISTE - ÉCROU POUR LAME ANTI-TEMPETE 	8		
BFS	BOLT FOR STORM PROTECTION - BOLZEN FÜR STURMLEISTE - VIS POUR LAME ANTI-TEMPETE 	8		
DFS	WASHER FOR STORM PROTECTION - DICHTSCHEIBE FÜR STURMLEISTE - RONDELLE POUR LAME ANTI-TEMPETE 	8		
RFP	POST HEIGHT ADJUSTMENT - REGULIERUNGSSCHRAUBE FÜR PFOSTEN - SUPPORT RÉGLABLE DE POTEAU 	4		
TRR1	TERRACE RAILING - TERRASSE - GARDE-CORPS DE TERRASSE 	4	850	1320



