

*Warwickshire double 3x4*  
Art.No. 4421980

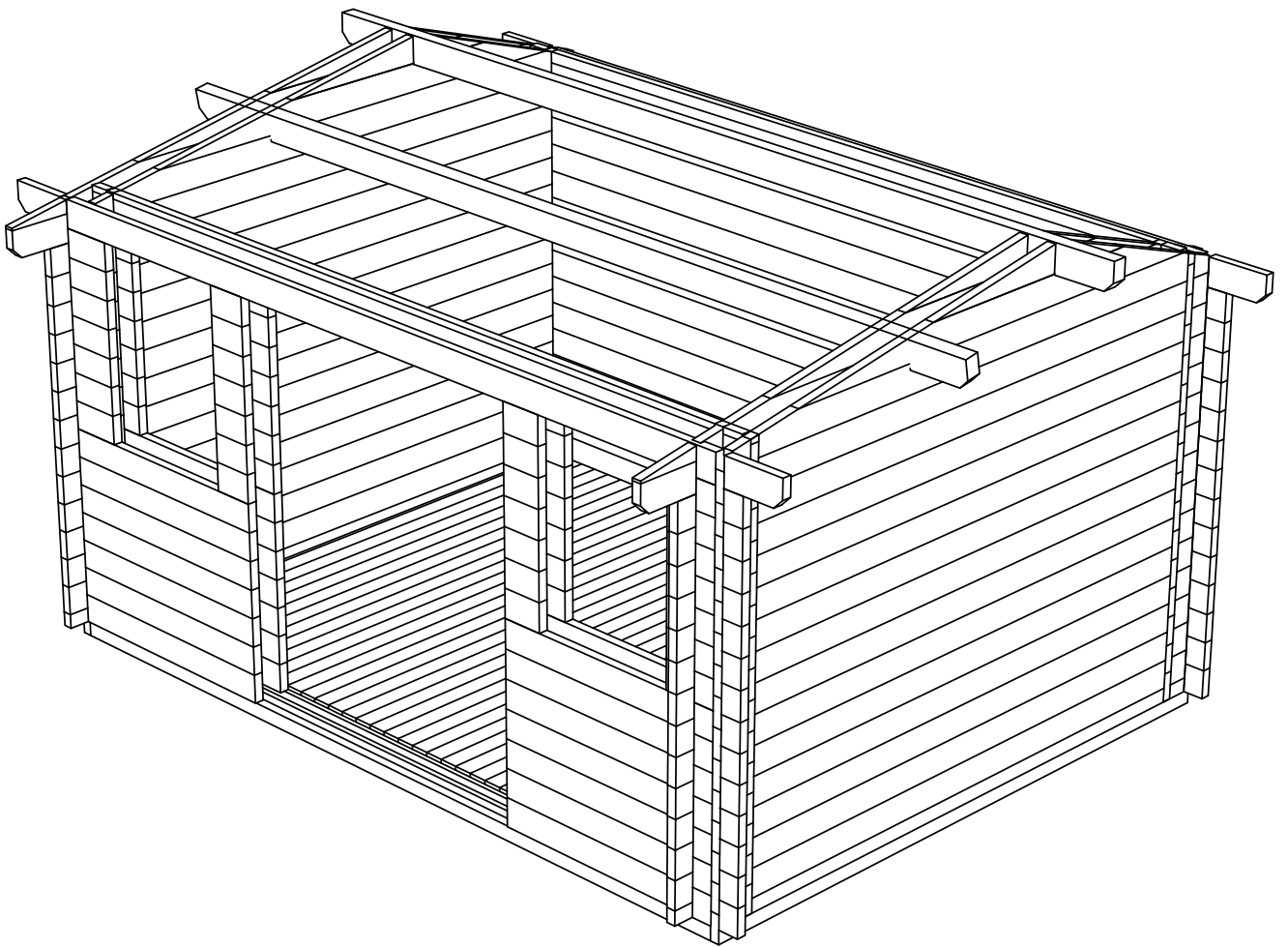

Warwickshire 3x4, Art.No.4421980  
 GRUNDPLAN - GRUNDPLAN - PLAN DE MASSE

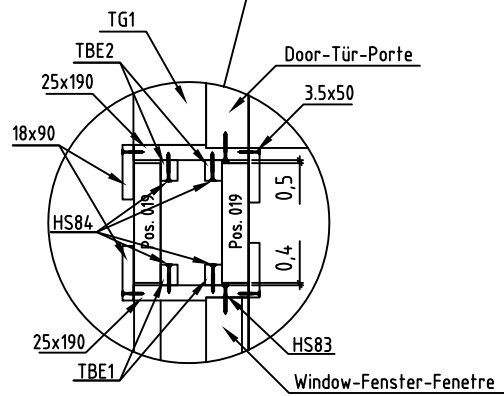

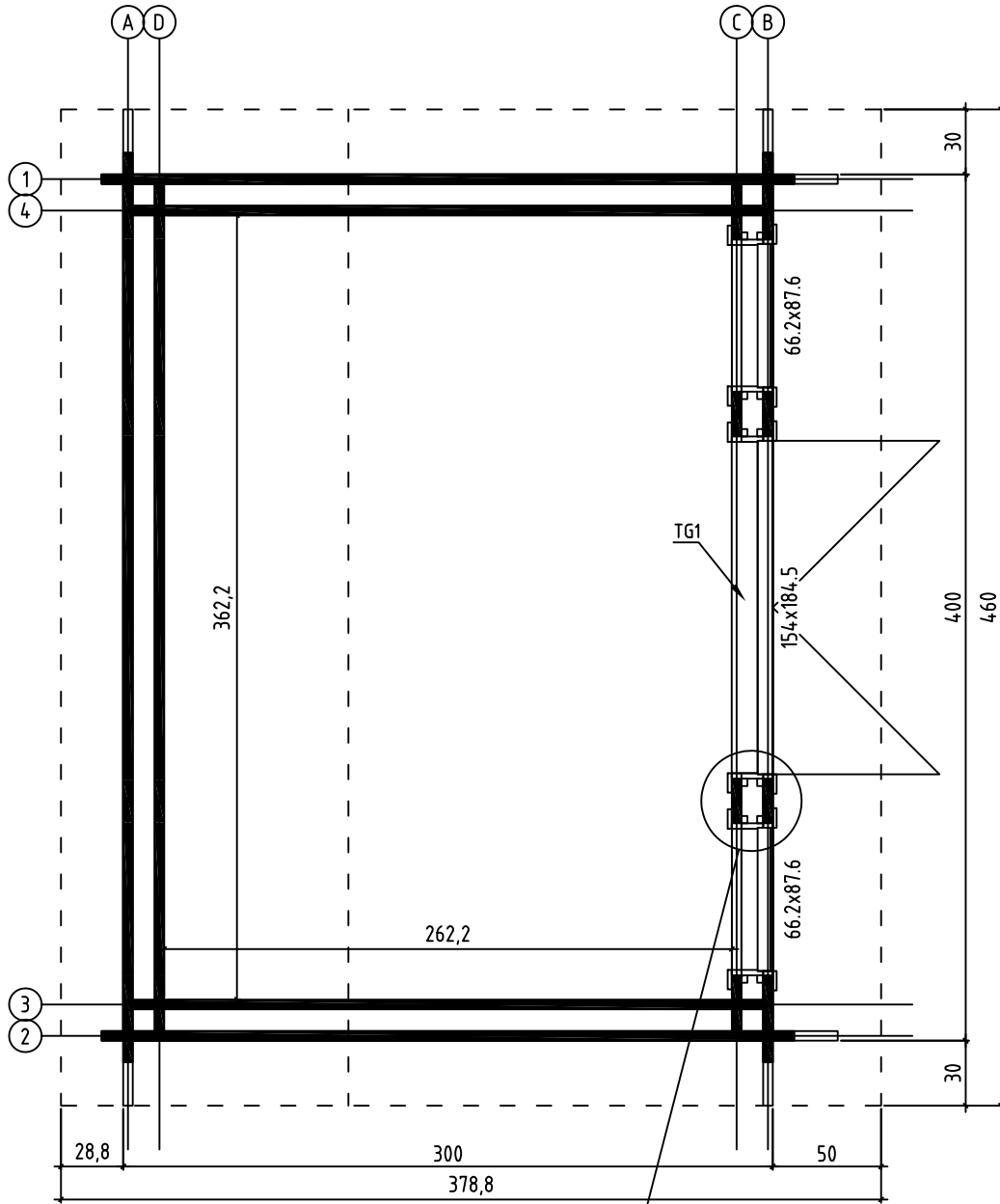
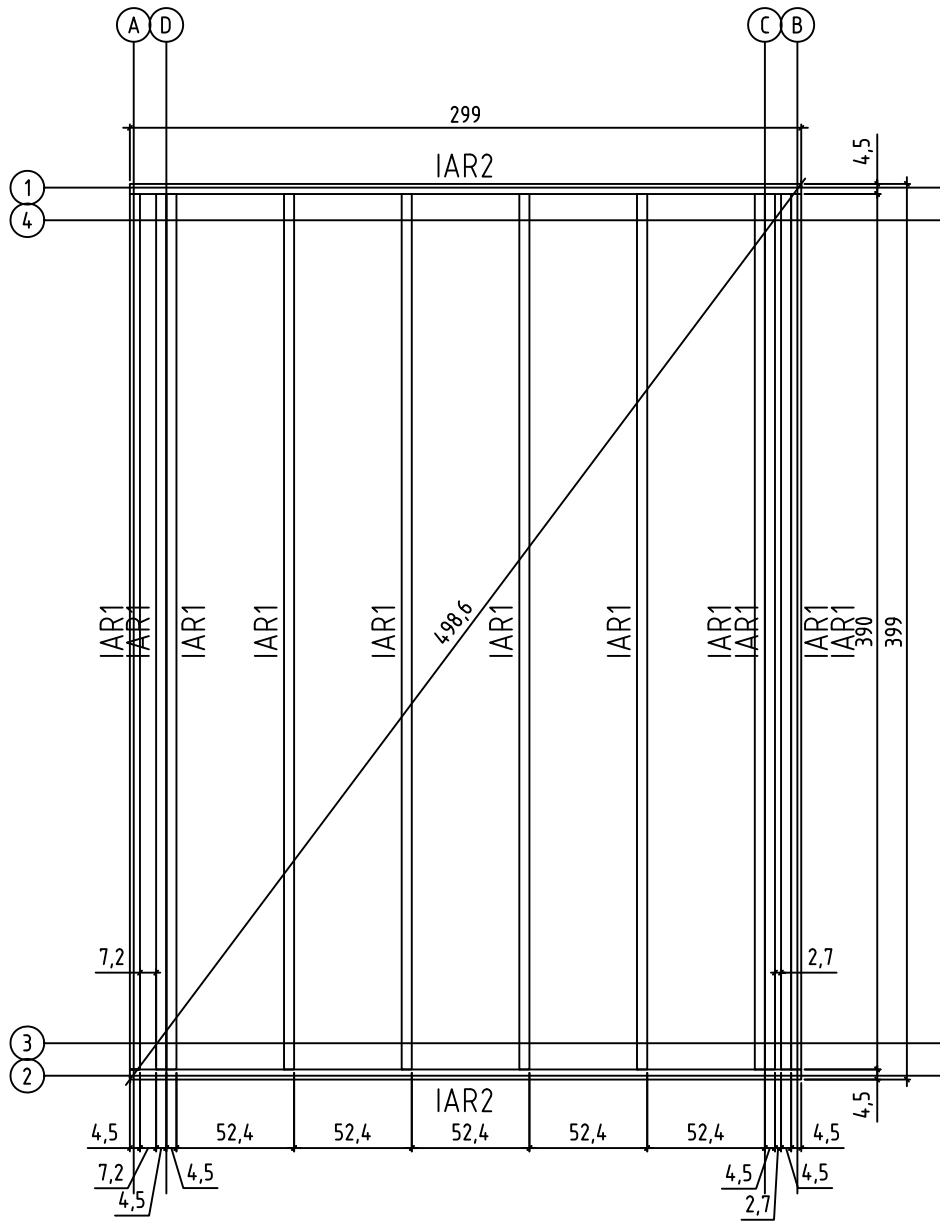

Warwickshire 3x4, Art.No.4421980  
FLOOR BOARDS - FUSSBODENBRETTER - PLAN POSE PLANCHER

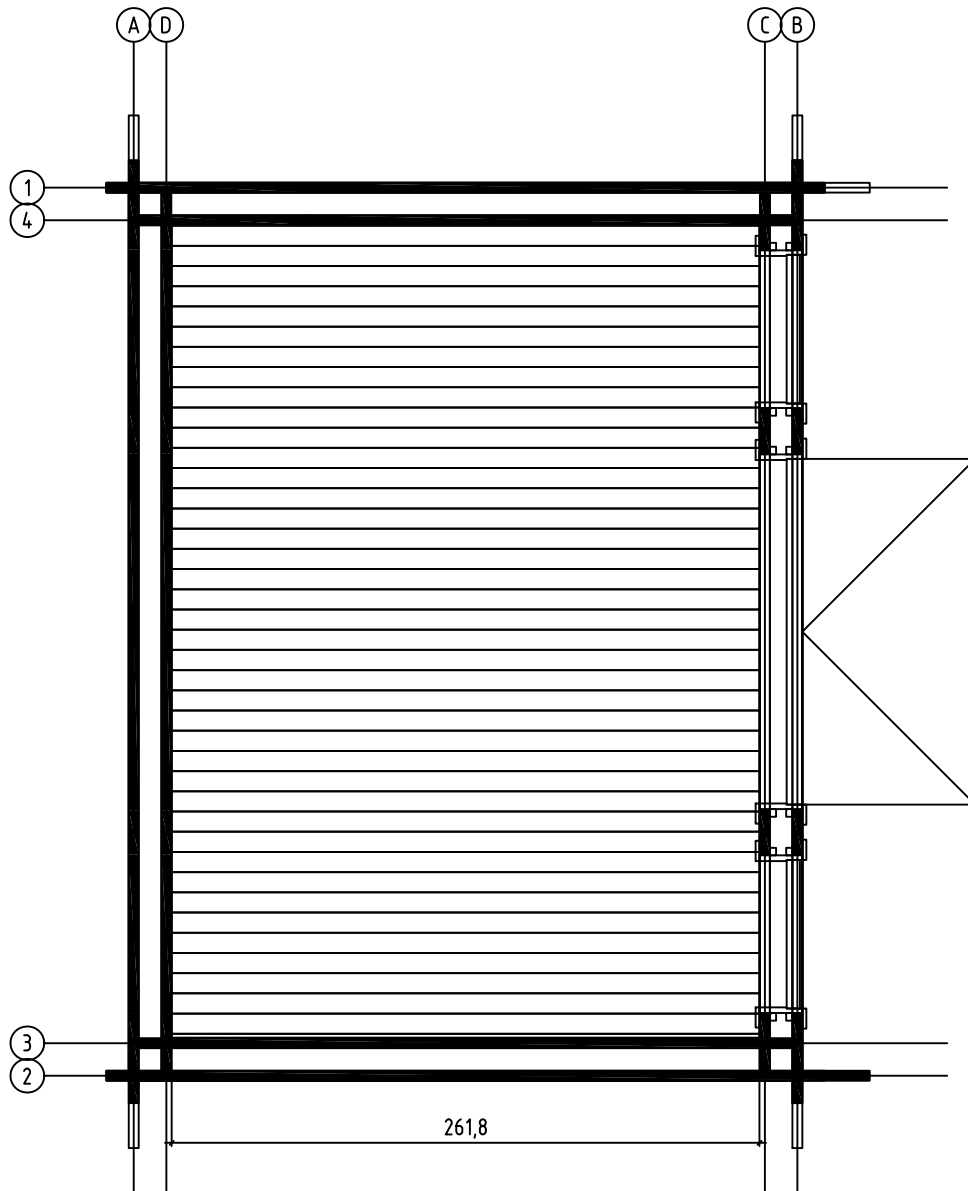

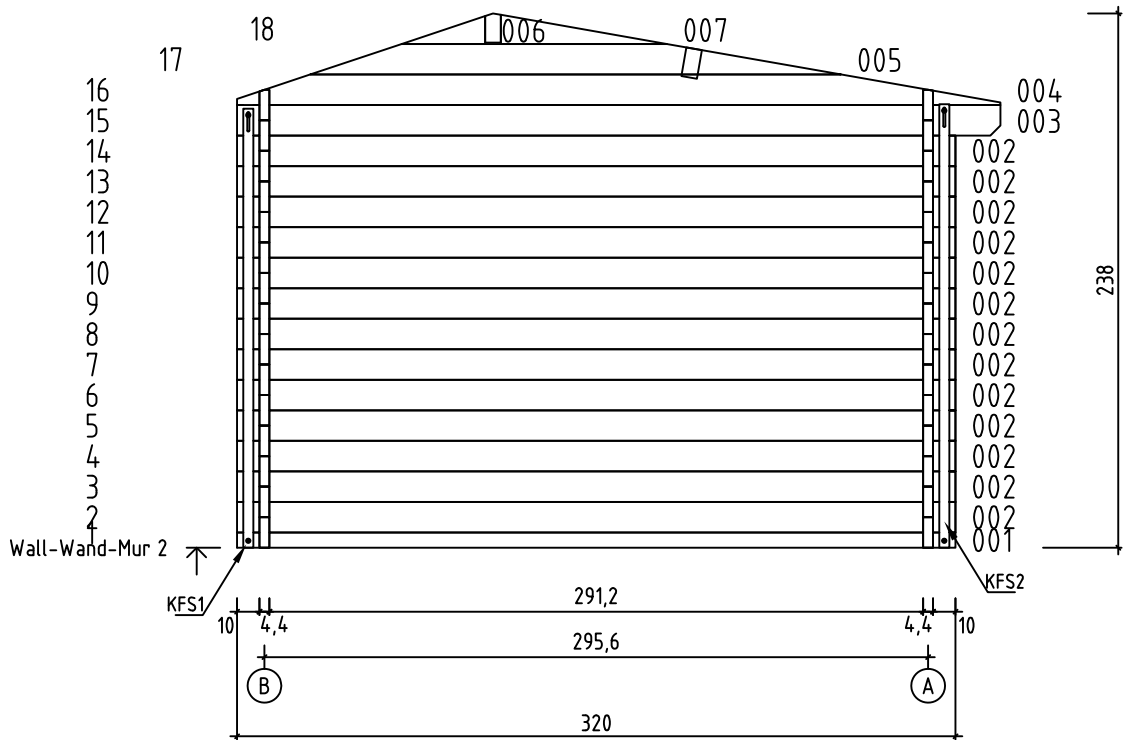
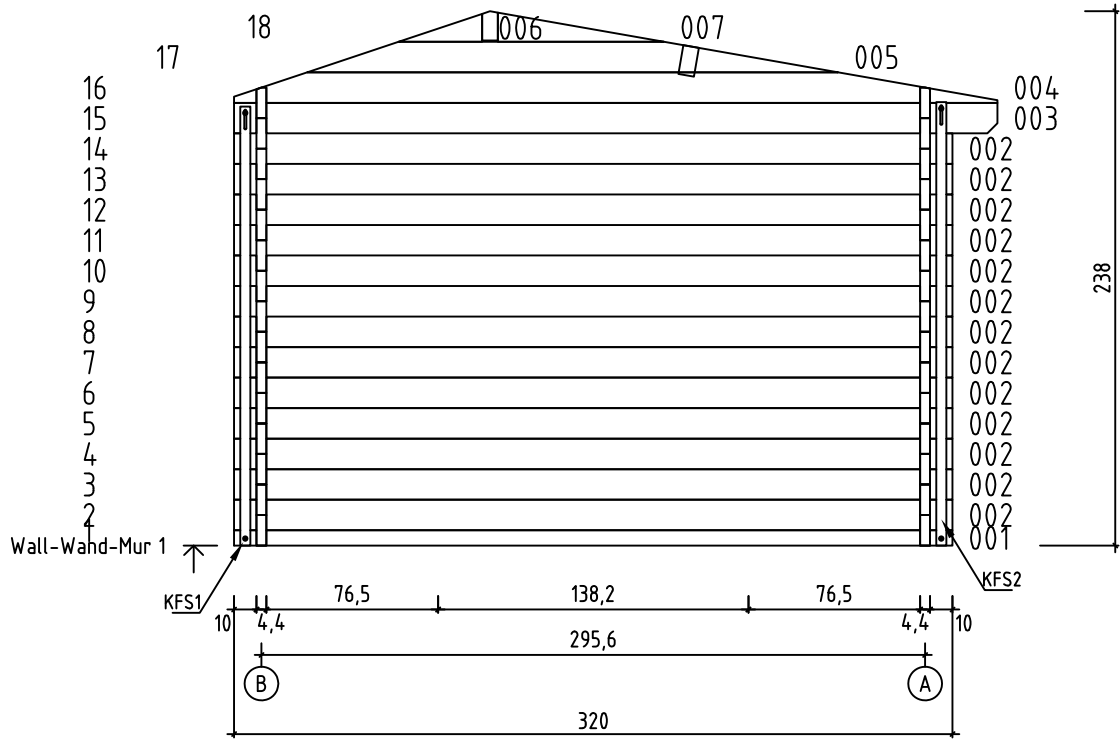

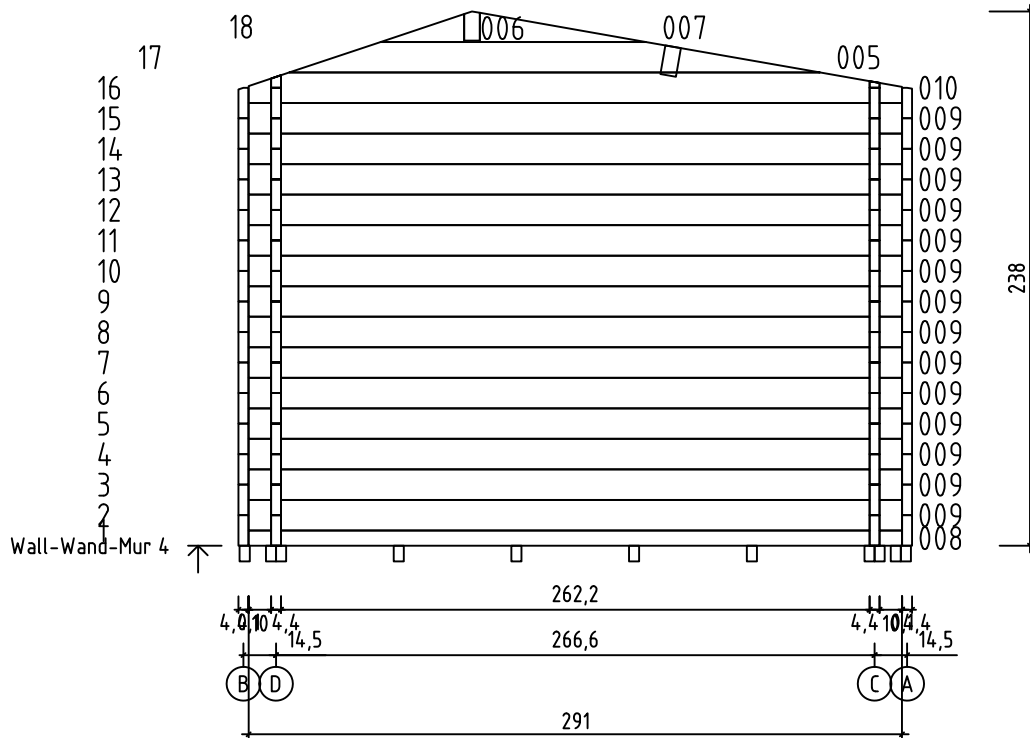
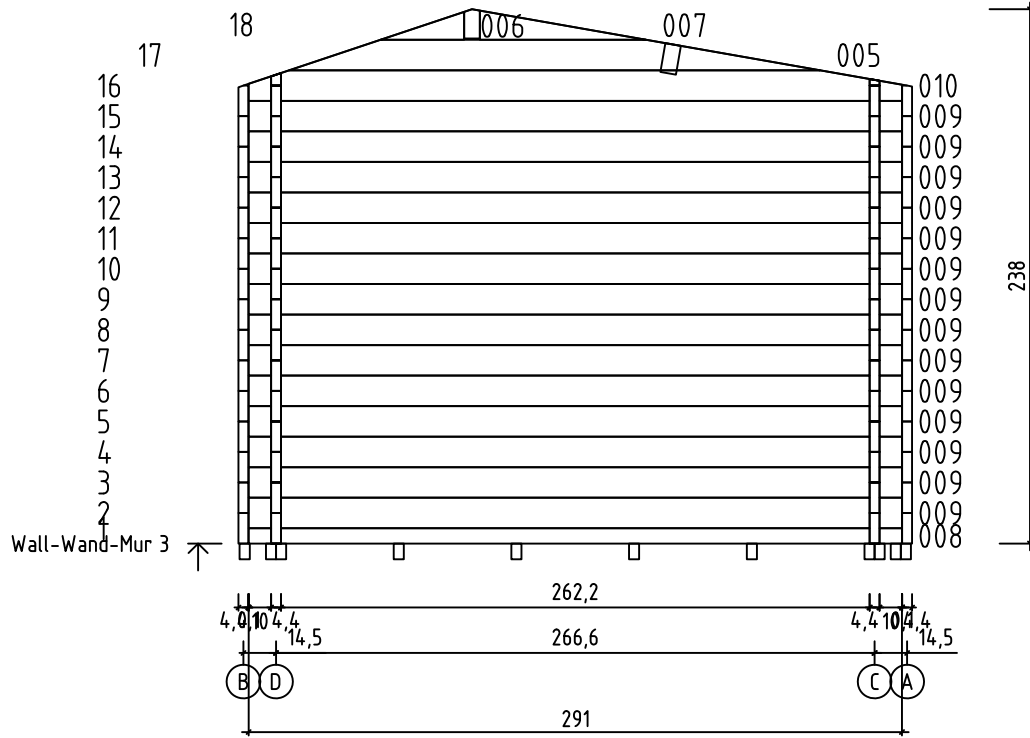

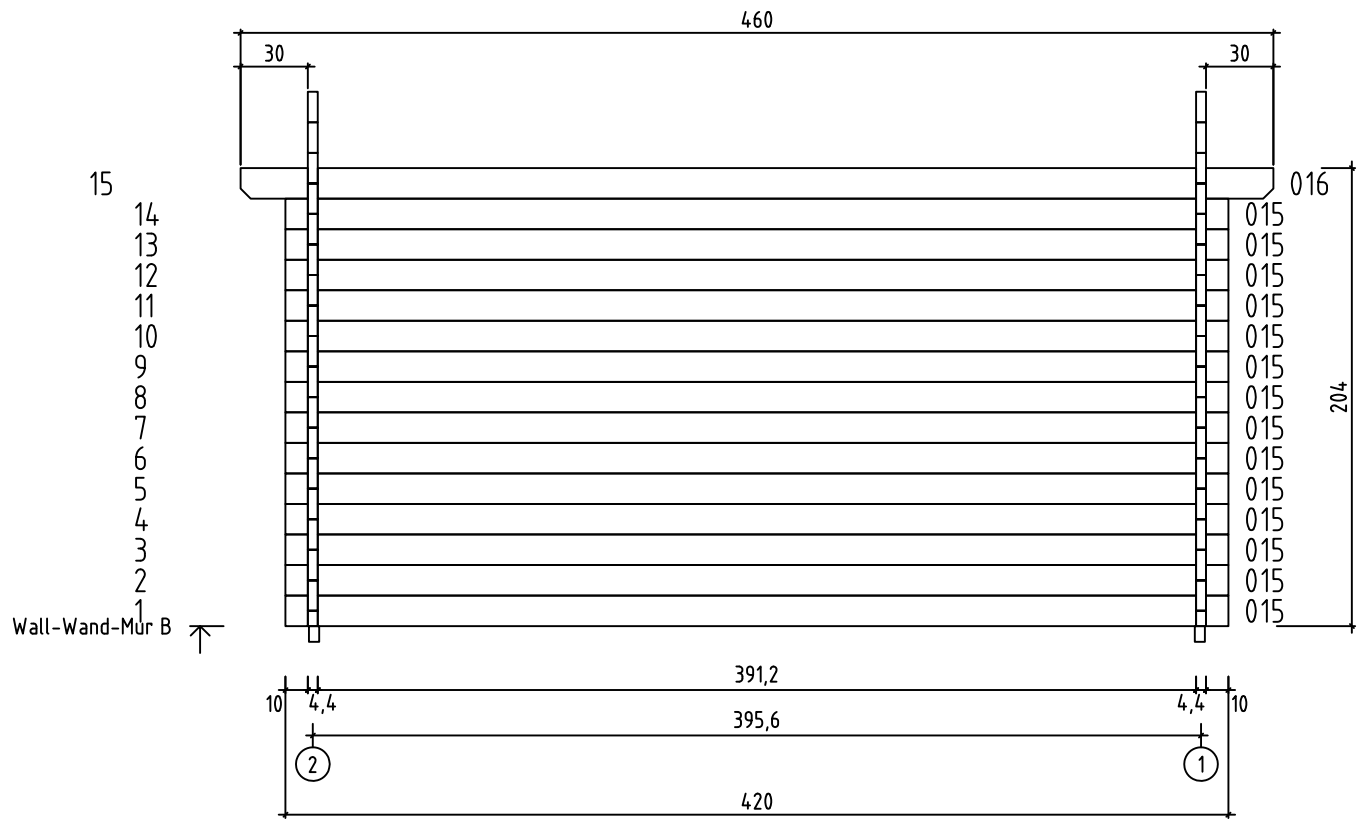
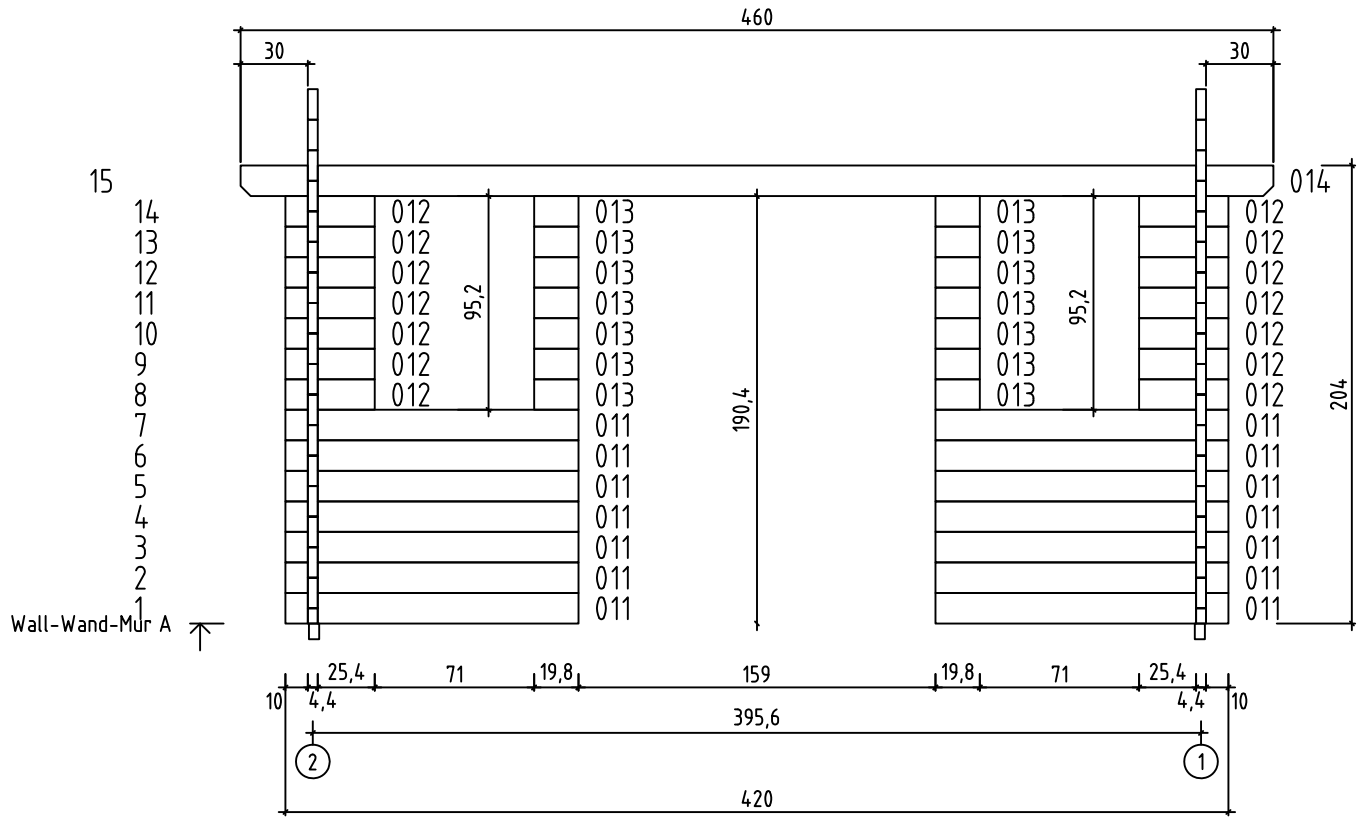

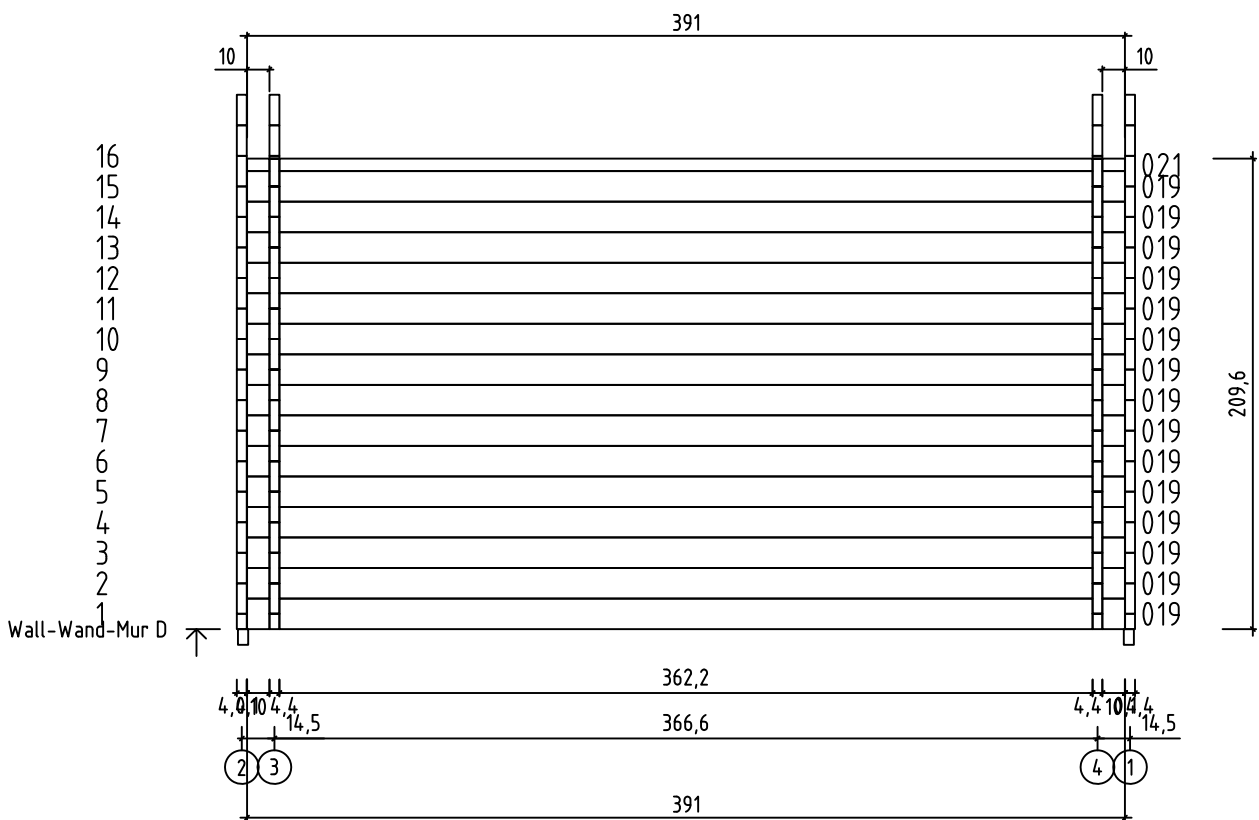
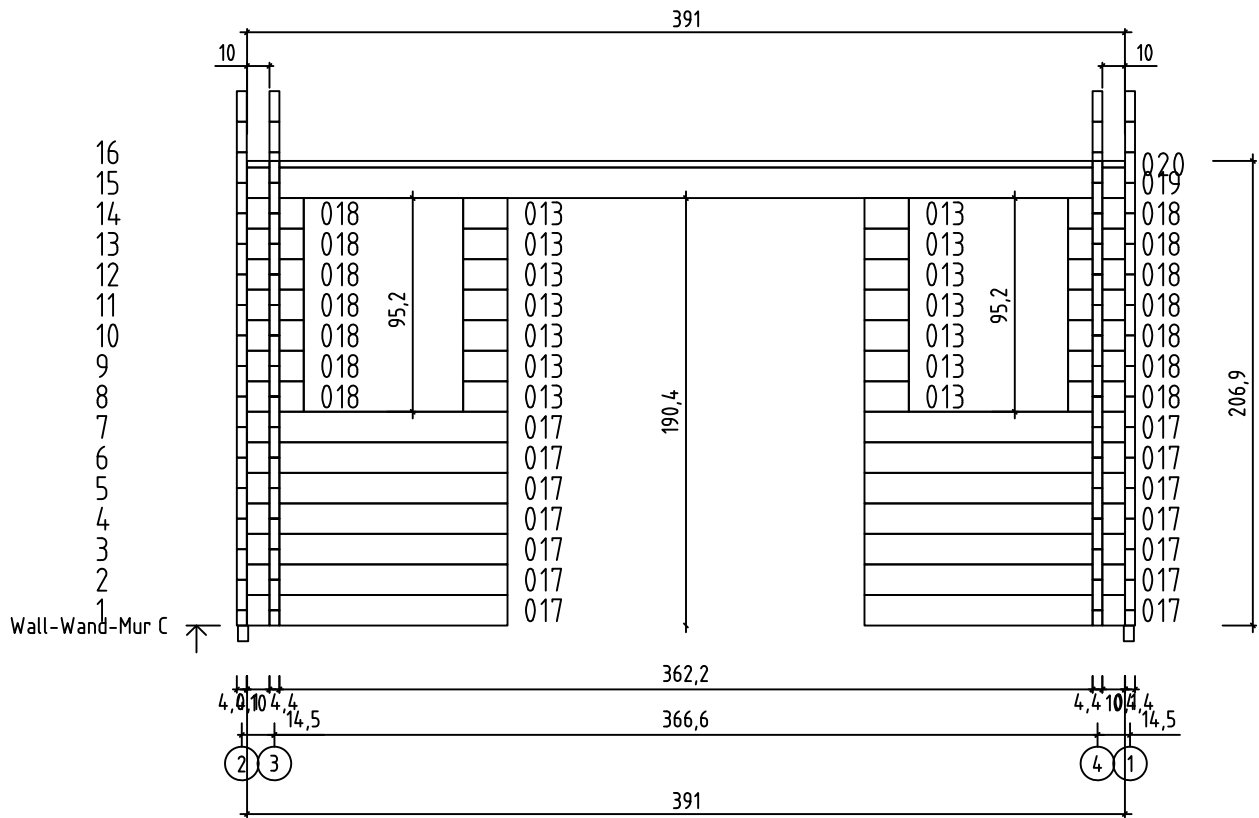



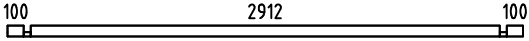
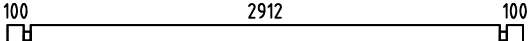
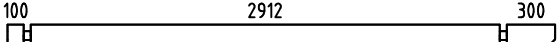
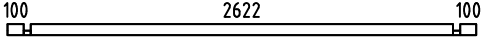
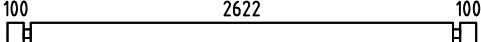
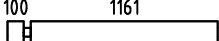

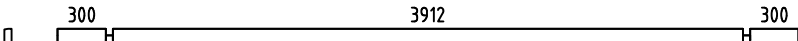
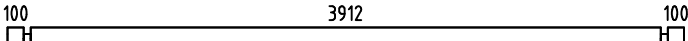
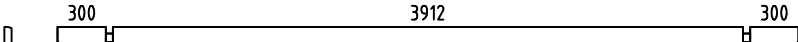
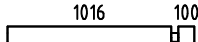

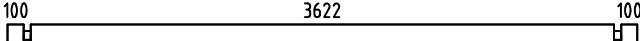
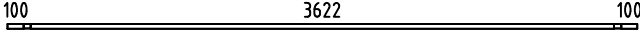
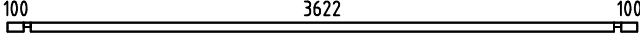
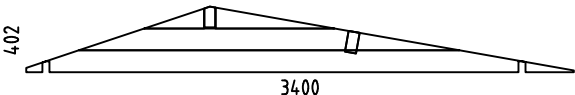
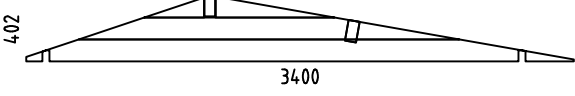
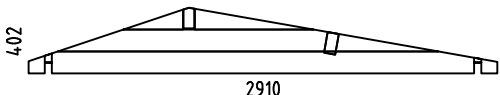
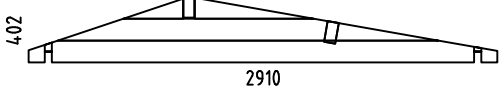



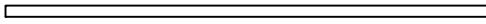

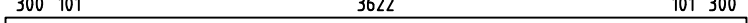

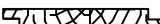



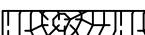
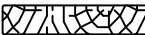



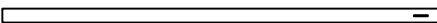
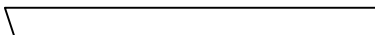
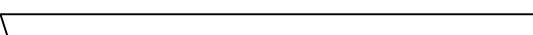

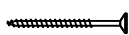

Pos	Warwickshire 3x4, Art.No.4421980 Piece list - Stückliste - Liste des pieces	Q.	P (mm)	L (mm)
001		2	44x68	3200
002		26	44x136	3200
003		2	44x136	3400
008		2	44x68	2910
009		28	44x136	2910
011		14	44x136	1305
012		14	44x136	398
013		28	44x136	198
014		1	44x136	4600
015		14	44x136	4200
016		1	44x136	4600
017		14	44x136	1160
018		14	44x136	253
019		16	44x136	3910
020		1	44x29	3910
021		1	44x56	3910
W1-1		1		
W2-1		1		
W3-1		1		
W4-1		1		
IAR1	FOUNDATION - FUNDAMENT - FONDATION 	11	45x70	3900

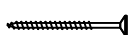
Pos	Warwickshire 3x4, Art.No.4421980 Piece list - Stückliste - Liste des pieces	Q.	P (mm)	L (mm)
IAR2	FOUNDATION - FUNDAMENT - FONDATION 	2	45x70	2990
PR1	ROOF BEAM - DACHBALKEN - PANNE DE TOIT 300 101 3622 101 300 	1	70x140	4600
A-PR1	ROOF BEAM - DACHBALKEN - PANNE DE TOIT 300 101 3622 101 300 	1	70x140	4600
	FLOOR BOARDS - FUSSBODENBRETTER - LAME DE PLANCHER 	41	90x18	2618
	ROOF BOARDS - DACHBRETTER - VOLIGES 	52	90x18	2500
	ROOF BOARDS - DACHBRETTER - VOLIGES 	52	90x18	1400
	FLOOR FILLET-FUSSBODENLEISTE - CORNIERE DE FINITION DU PLANCHER 		15x40	12.5 m.
DPL	ROOFING FELT FILLET - DACHPAPPENLEISTE - BAGUETTE DE FIXATION DU FEUTRE BITUMEUX 	2	18x58	1455
DPL	ROOFING FELT FILLET - DACHPAPPENLEISTE - BAGUETTE DE FIXATION DU FEUTRE BITUMEUX 	2	18x58	2555
TG1	DOORSTEP - SWELLE - SEUIL DE PORTE 	1	18x120	1530
TB	EAVES BOARD - TRAUFBRETT - BANDEAU DE TOIT 	2	18x90	4600
DRV	ROOF EDGE REINFORCEMENT - DACHRANDVERSTÄRKUNG - CORNIERE DE RENFORT DE BORD DE TOIT 	2	28x34	4600
TBE1	FIXING FILLET - FIXIRUNGSLEISTE - PROFIL DE FIXATION 	8	28x34	916
TBE2	FIXING FILLET - FIXIRUNGSLEISTE - PROFIL DE FIXATION 	4	28x34	1865
KFS1	STORM PROTECTION - STURMLEISTE - LATTE ANTI TEMPETE 	2	22x45	1955
KFS2	STORM PROTECTION - STURMLEISTE - LATTE ANTI TEMPETE 	2	22x45	1975
GL	GABLE MOULDING - GIEBELLEISTE - PLANCHE DE RIVE 	2	18x120	1455
GL	GABLE MOULDING - GIEBELLEISTE PLANCHE DE RIVE 	2	18x120	2555
GS	GABLE SEGMENT-DECKBLATT - LOSANGE DE FINITION 	2		
SH44	HAMMER BLOCK - SCHLAGHOLZ - CALLE DE FRAPPE 	1		
HS12	SCREW FOR GABLE SEGMENT - SCHRAUBEN FÜR DECKBLATT - VIS POUR FIXATION LOSANGE DE FINITION 	4	3.5x35	
HS83	SCREW FOR FIXING FILLET - SCHRAUBEN FÜR FIXIRUNGSLEISTE - VIS POUR PROFIL DE FIXATION 	45	3.5x50	
HS84	SCREW FOR FIXING FILLET - SCHRAUBEN FÜR FIXIRUNGSLEISTE - VIS POUR PROFIL DE FIXATION 	47	3.5x50	
HS59	SCREW FOR FIXING DOORSTEP - SCHRAUBEN FÜR SWELLE VIS DE FIXATION SEUIL DE PORTE 	4	3.5x50	
HS16	SCREW FOR GABLE MOULDING - SCHRAUBEN FÜR GIEBELLEISTE - VIS DE FIXATION POUR PLANCHE DE RIVE 	20	3.5x50	



